

(土器実測図 : S=1/8)

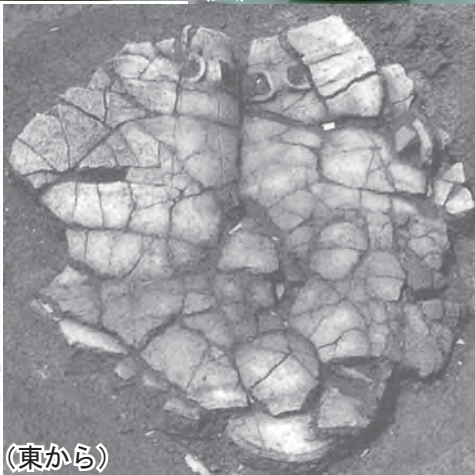

宮竹あつ坂遺跡
土器棺

『能美丘陵東遺跡群Ⅴ』(1999)

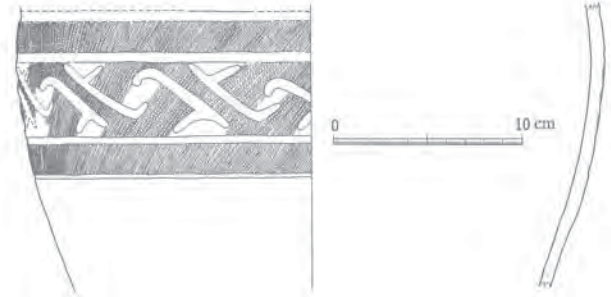

(土器実測図 : S=1/4)

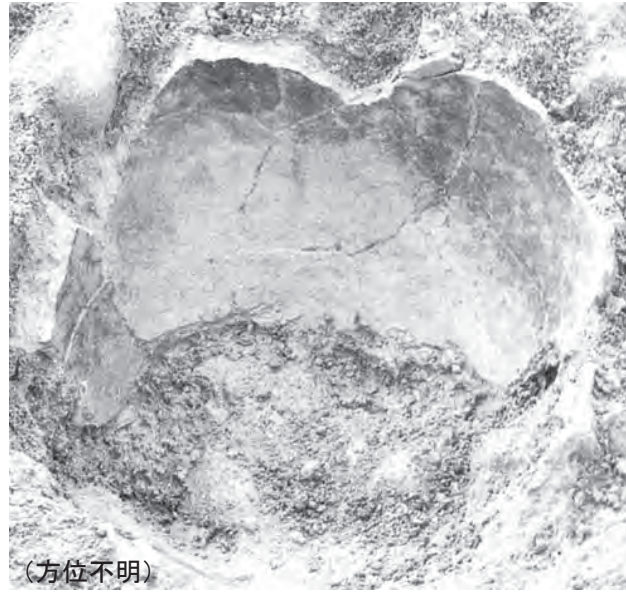

(方位不明)

白山遺跡
埋甕 457

『鶴来町白山遺跡・白山町墳墓遺跡 (II)』(1985)

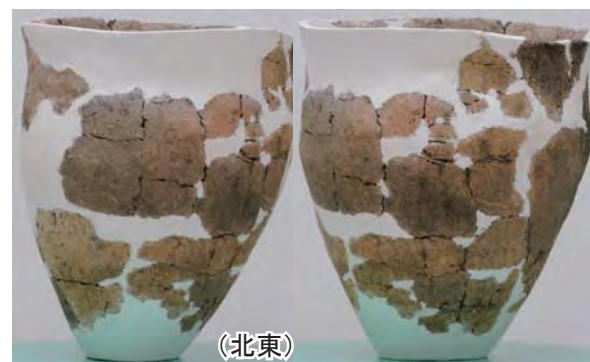
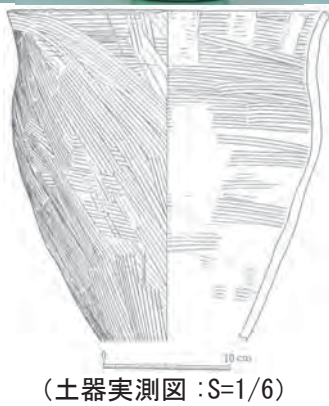
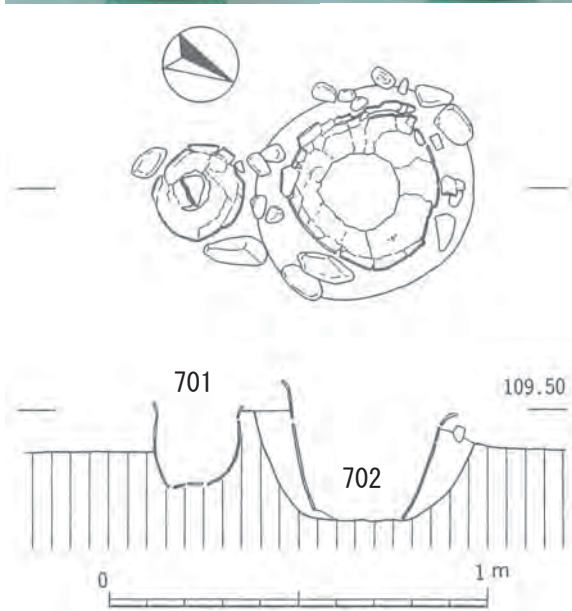

白山遺跡
埋甕 701

『鶴来町白山遺跡・白山町墳墓遺跡（Ⅱ）』（1985）

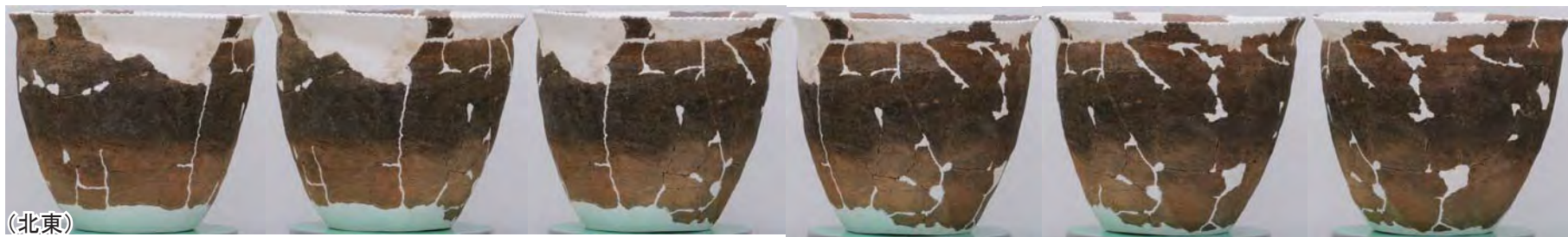

(北東)

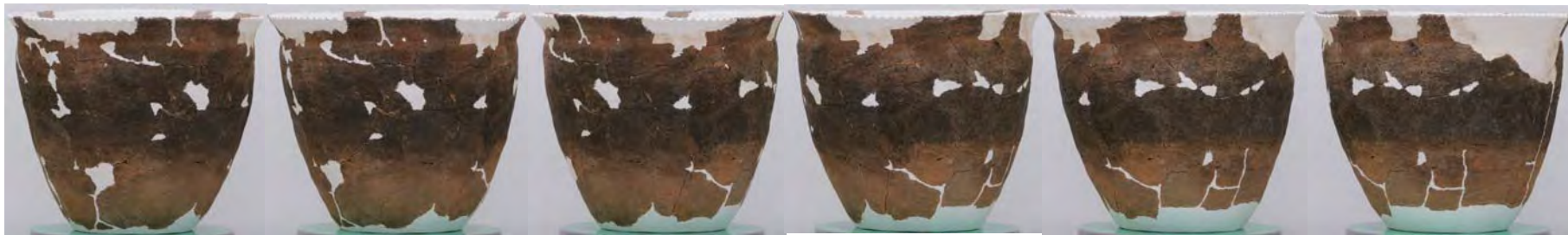

(土器実測図 : S=1/12)

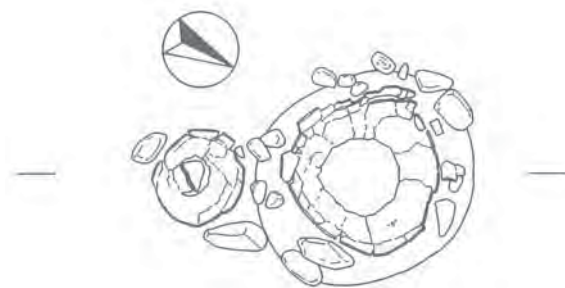

(北東から)

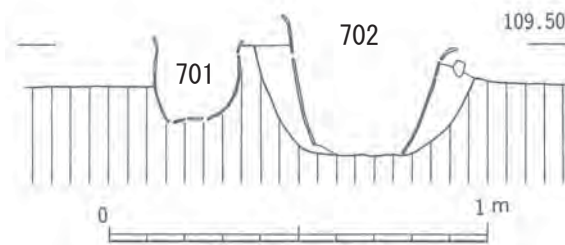

白山遺跡
埋甕 702

『鶴来町白山遺跡・白山町墳墓遺跡 (II)』(1985)

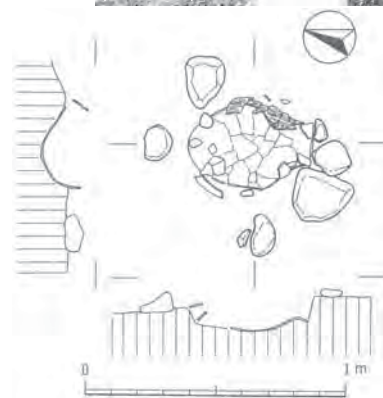
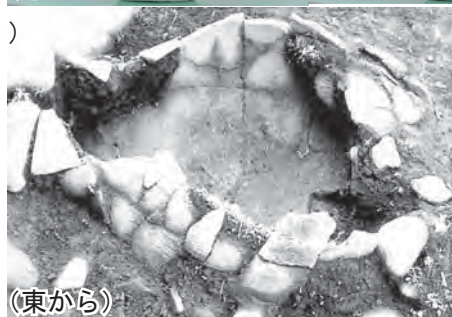

白山遺跡
壺 644

『鶴来町白山遺跡・白山町墳墓遺跡 (II)』(1985)

(土器実測図 : S=1/8)



(土器実測図 : S=1/6)

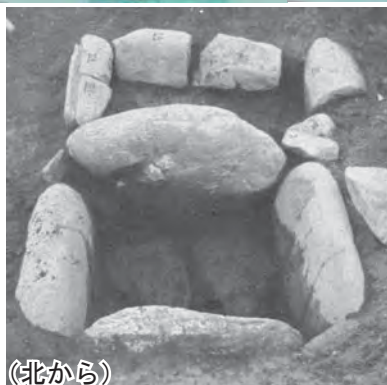

(北から)

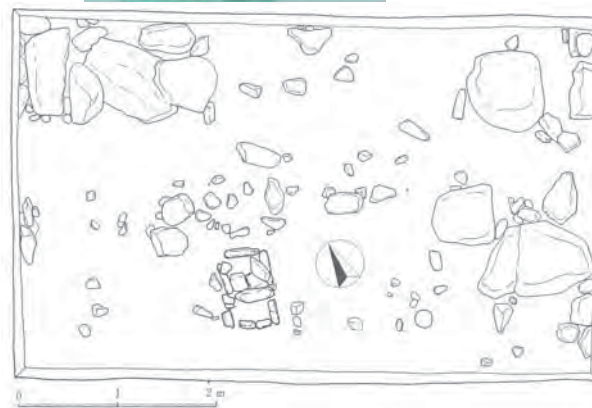
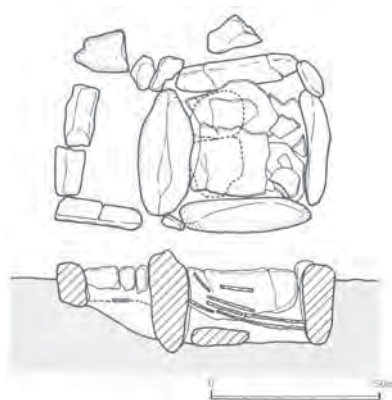

尾添遺跡
2号炉1

『尾口村尾添遺跡発掘調査報告』(1977)

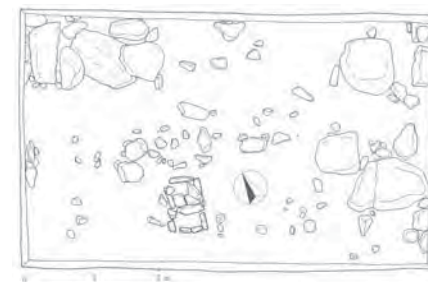
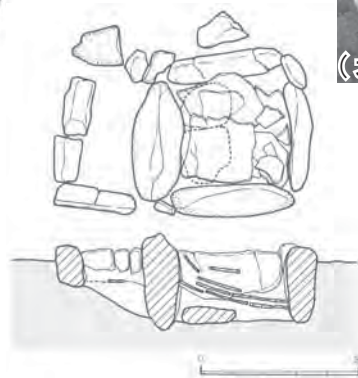
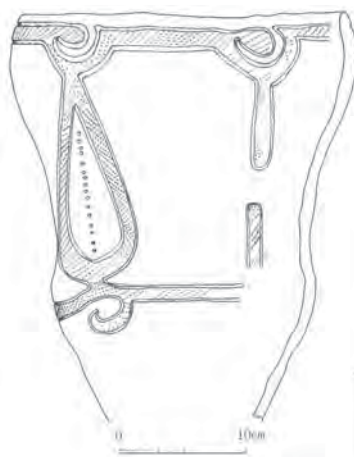
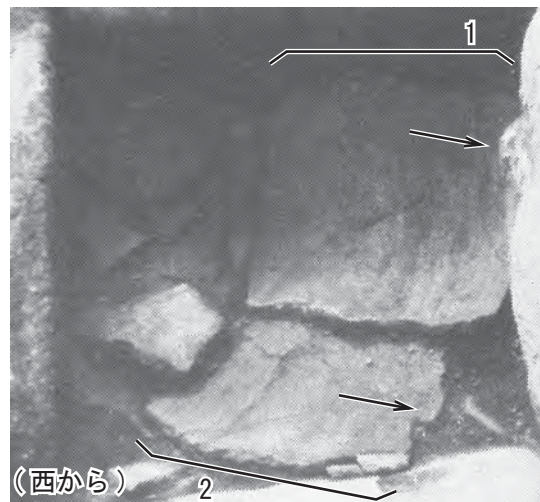

尾添遺跡
2号炉2

『尾口村尾添遺跡発掘調査報告』(1977)

(土器実測図 : S=1/6)



尾添遺跡
2号炉3

『尾口村尾添遺跡発掘調査報告』(1977)

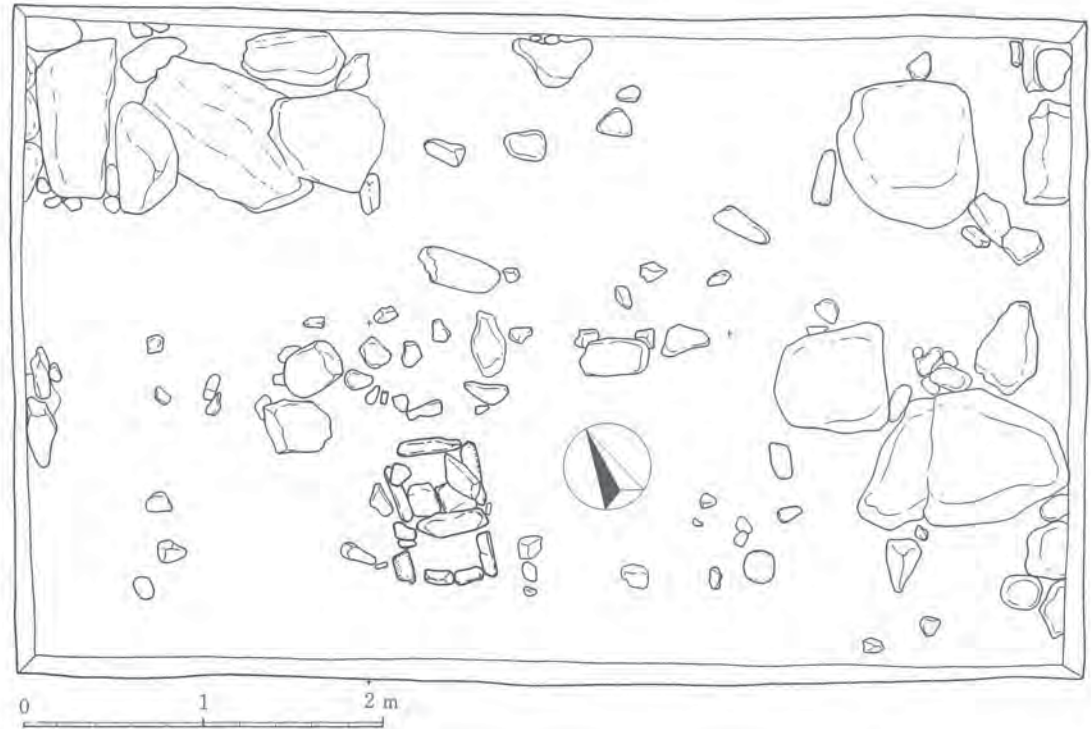
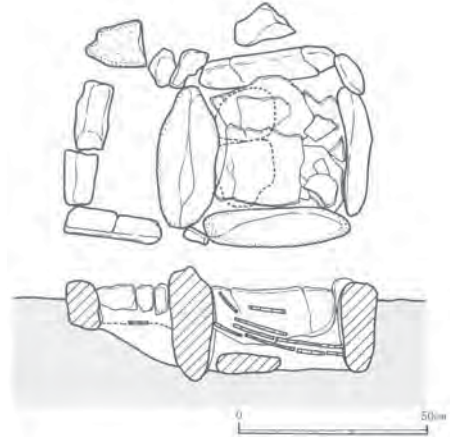



尾添遺跡

『尾口村尾添遺跡発掘調査報告』(1977)

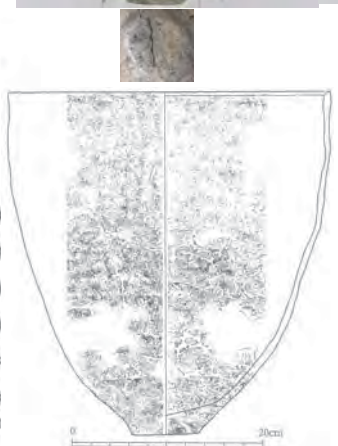
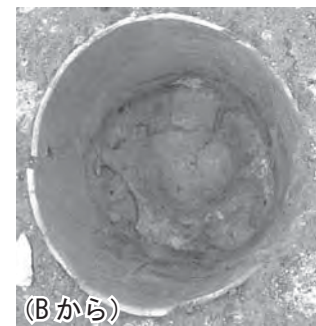
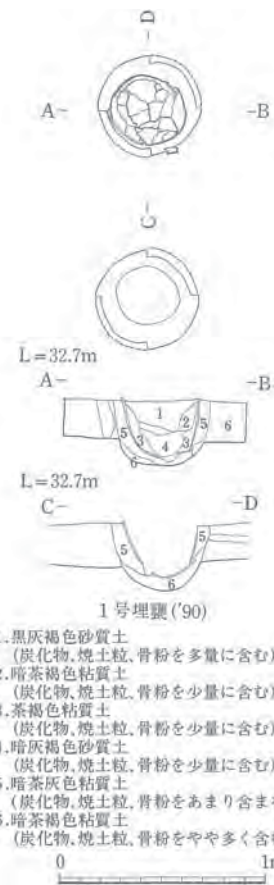

六橋遺跡
1号埋甕 171

『六橋遺跡』(1997)

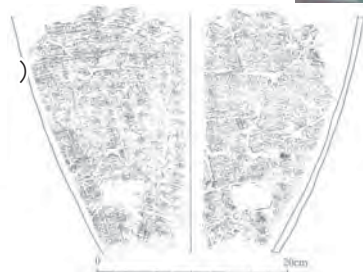
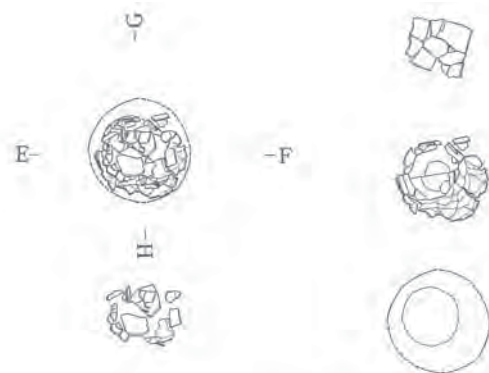

(土器実測図 : S=1/8)



- L=32.7m
1. 黒灰褐色砂質土
(炭化物、焼土粒、骨粉を多量に含む)
 2. 暗茶褐色粘質土
(炭化物、焼土粒、骨粉を少量に含む)
 3. 茶褐色粘質土
(炭化物、焼土粒、骨粉を少量に含む)
 4. 暗灰褐色砂質土
(炭化物、焼土粒、骨粉を少量に含む)
 5. 暗茶灰色粘質土
(炭化物、焼土粒、骨粉をあまり含まない)
 6. 暗茶褐色粘質土
(炭化物、焼土粒、骨粉をやや多く含む)
- L=32.7m
- 0 1m
- 2号埋甕('90)



六橋遺跡
2号埋甕 173

『六橋遺跡』(1997)

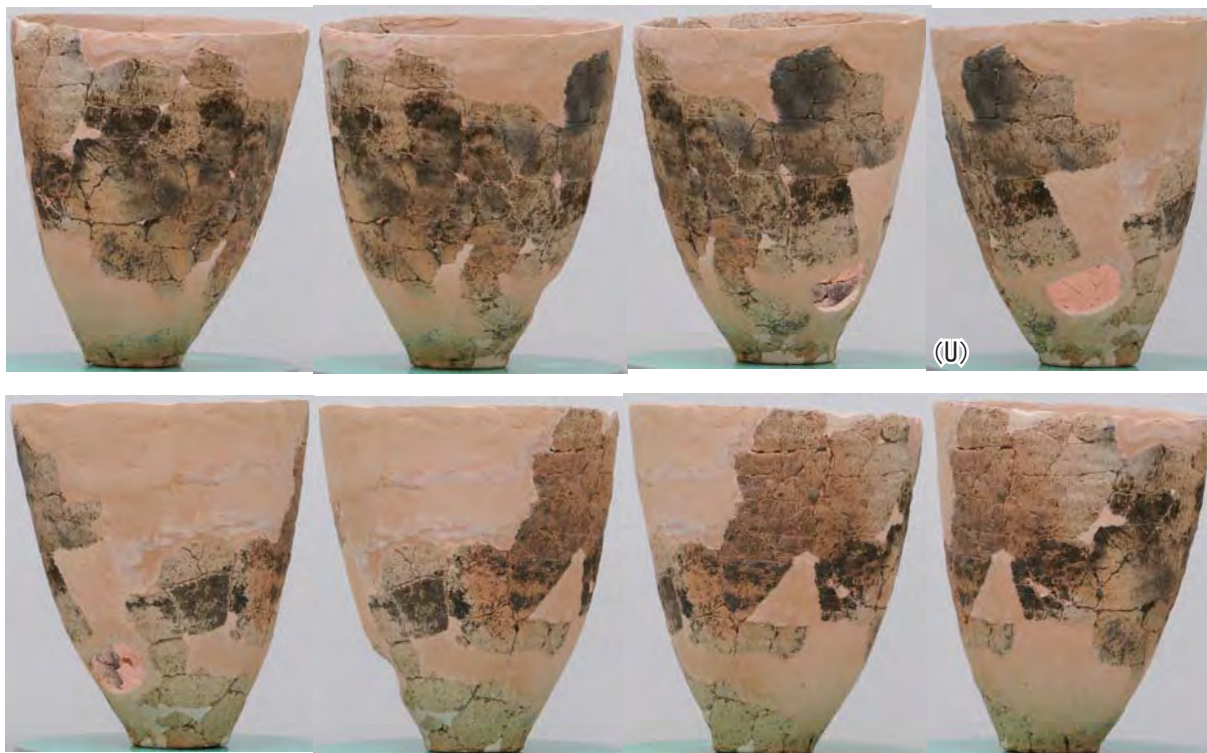

(U)



(土器実測図 : S=1/8)



(Uから)

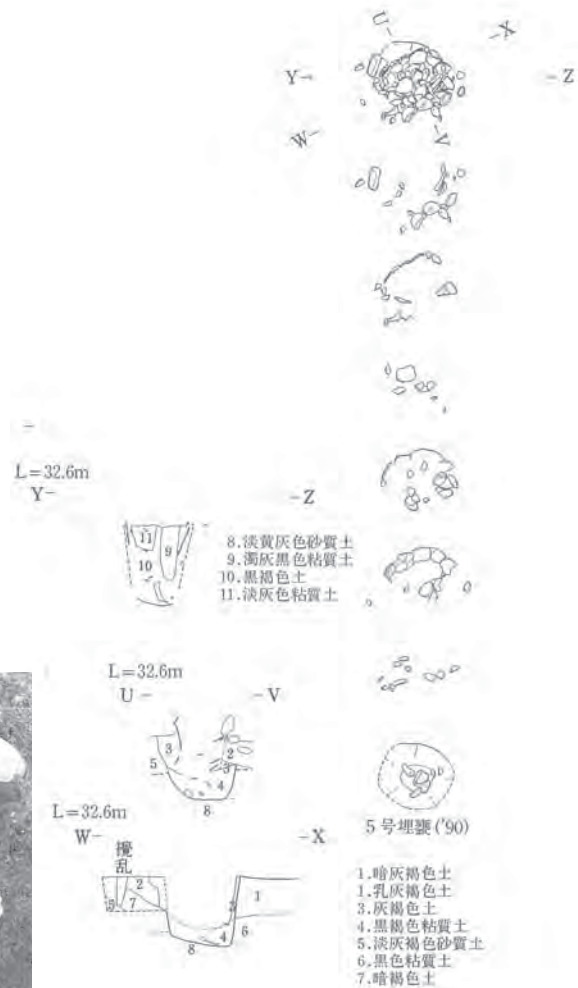

六橋遺跡
5号埋甕 175

『六橋遺跡』(1997)

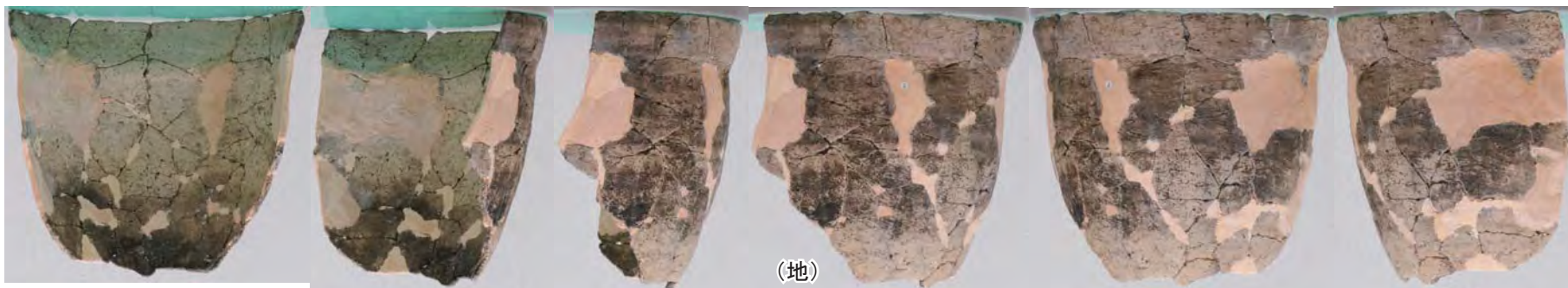

(地)

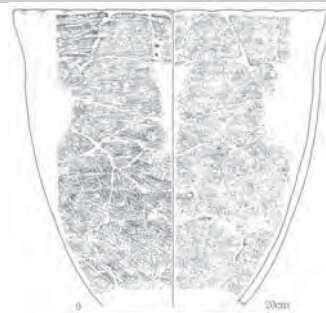

(土器実測図 : S=1/8)

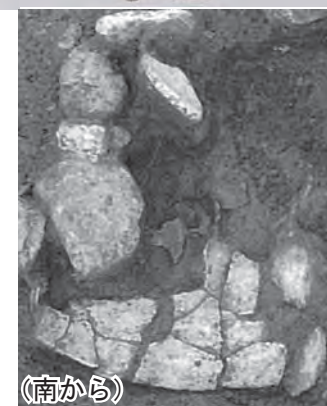
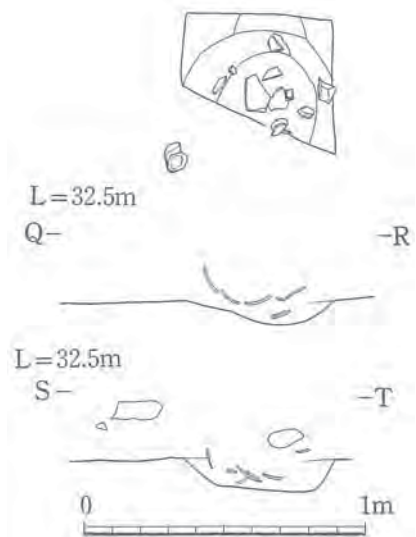

(南から)

六橋遺跡
90-1号土器棺 174
『六橋遺跡』(1997)



(天)

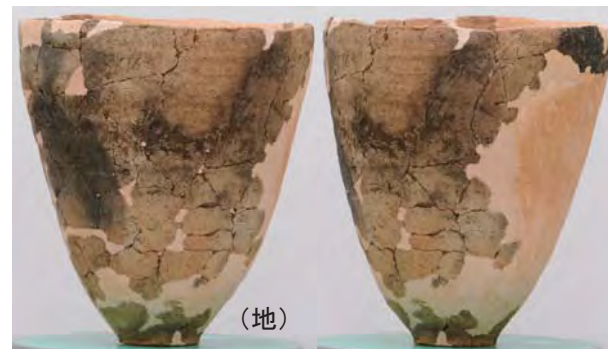

(地)

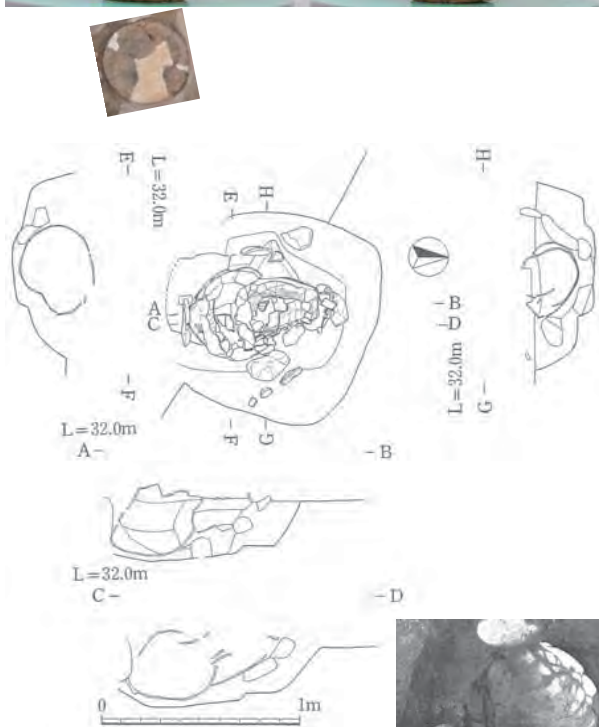

(北から)

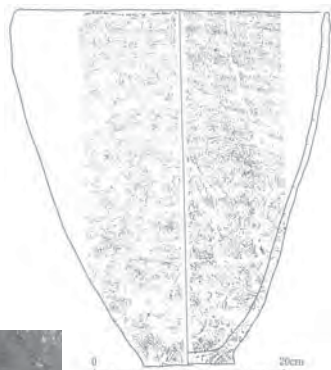

(土器実測図 : S=1/8)



(西から)

六橋遺跡
91-1号土器棺 177
『六橋遺跡』(1997)



(北から)

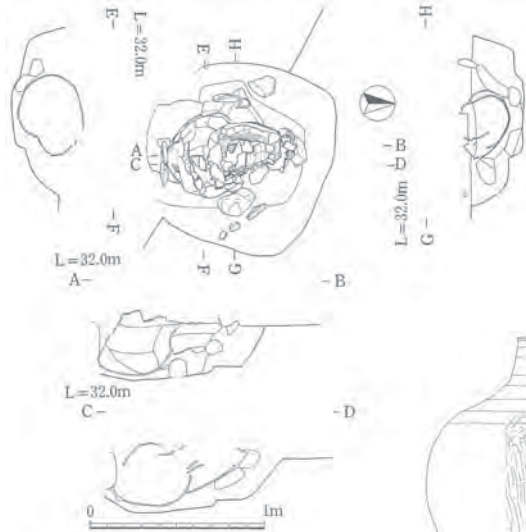
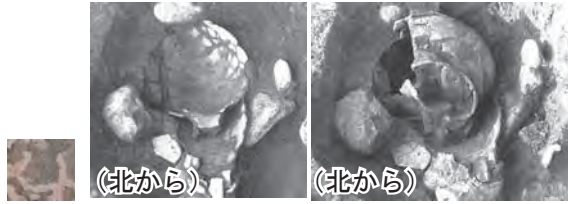

六橋遺跡
91-1号土器棺 179
『六橋遺跡』(1997)

(土器実測図：
S=1/12)

(西からを 90° 回転)



(天)

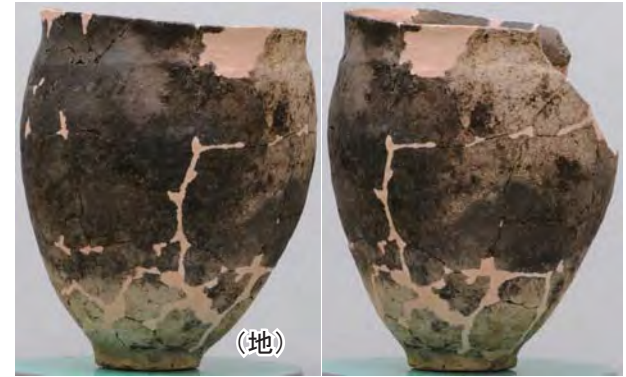
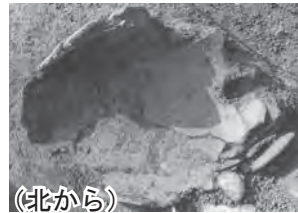
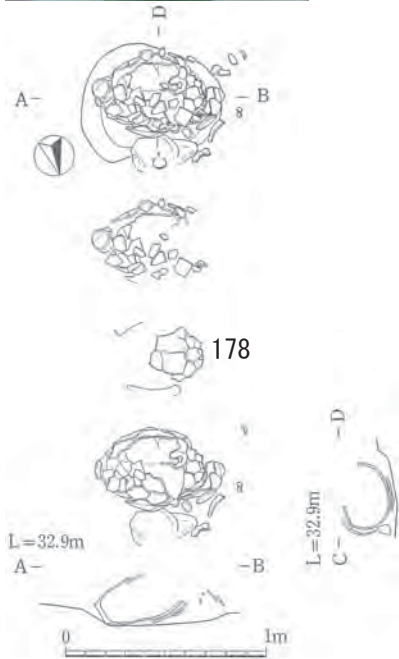

(土器実測図 : S=1/8)

六橋遺跡
91-2号土器棺 176
『六橋遺跡』(1997)



(北からを90°回転)

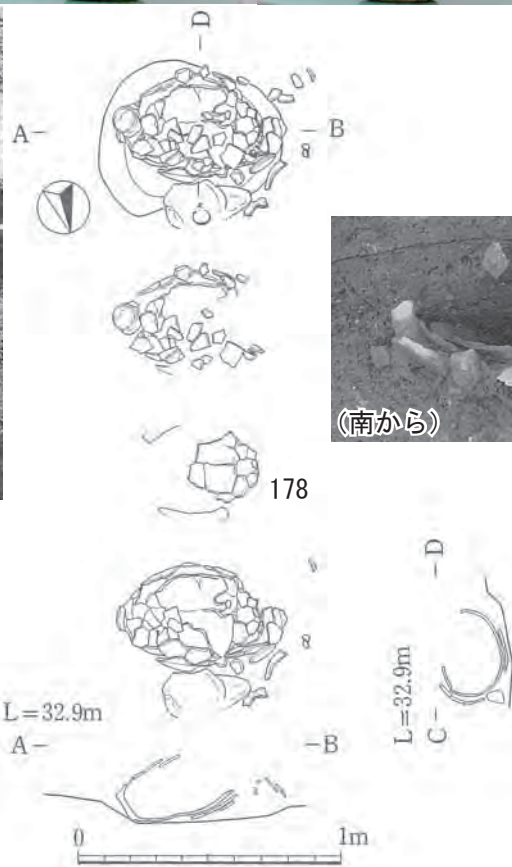

178



(土器実測図 : S=1/8)

六橋遺跡
91-2号土器棺 178
『六橋遺跡』(1997)



(土器実測図 : S=1/6)

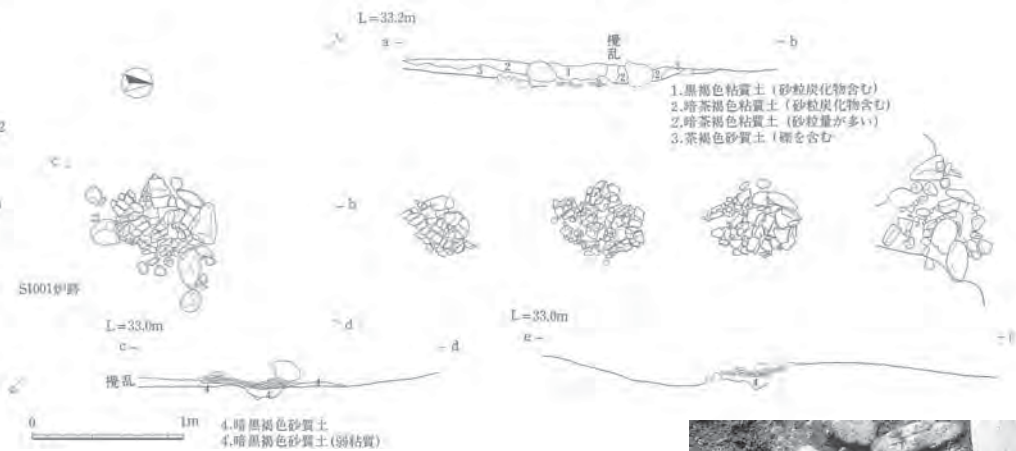

(南東から)



(南東から)

六橋遺跡
91SI001-41

『六橋遺跡』(1997)

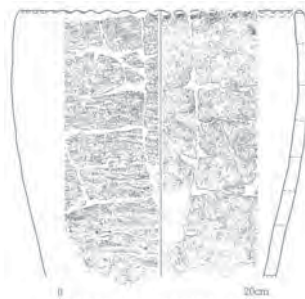
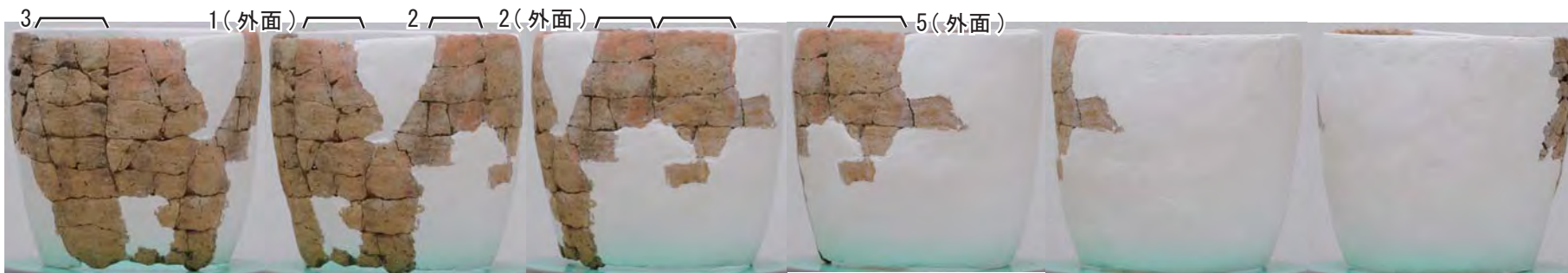

(土器実測図 : S=1/8)

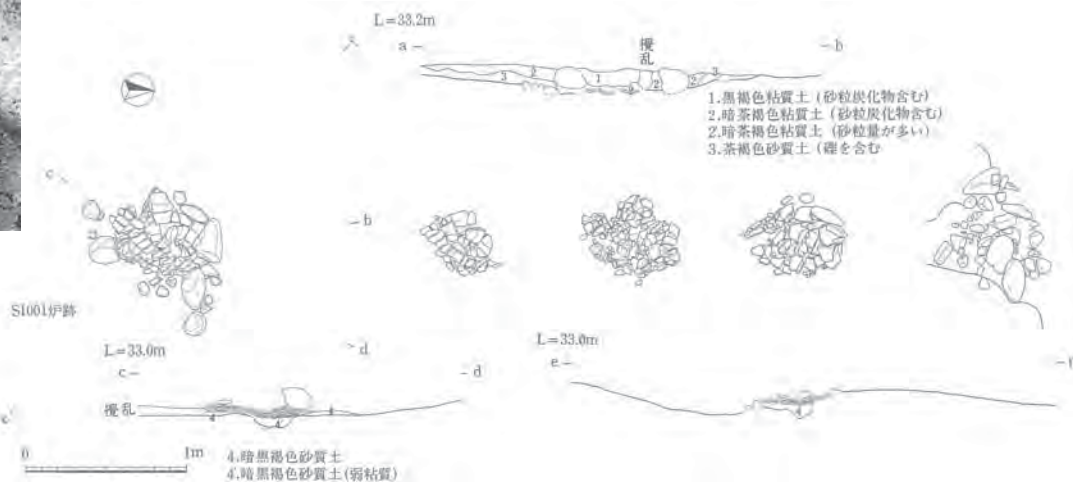

六橋遺跡
91SI001-42
『六橋遺跡』(1997)

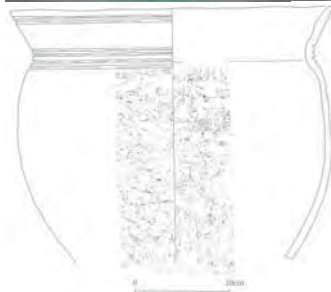

(土器実測図 : S=1/8)



(南東から)



(南東から)

六橋遺跡
91SI001-43

『六橋遺跡』(1997)

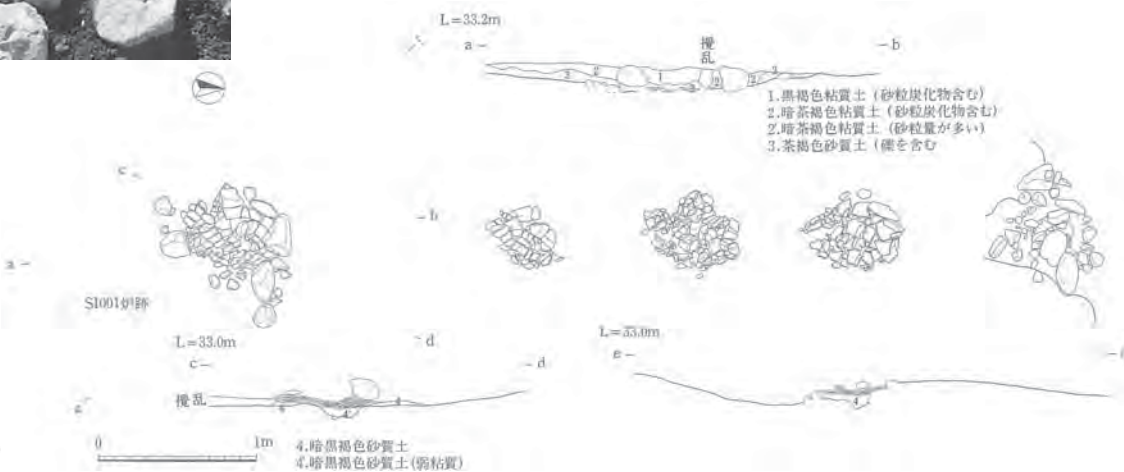



(北)



(土器実測図 : S=1/6)



(北からを天地逆転)

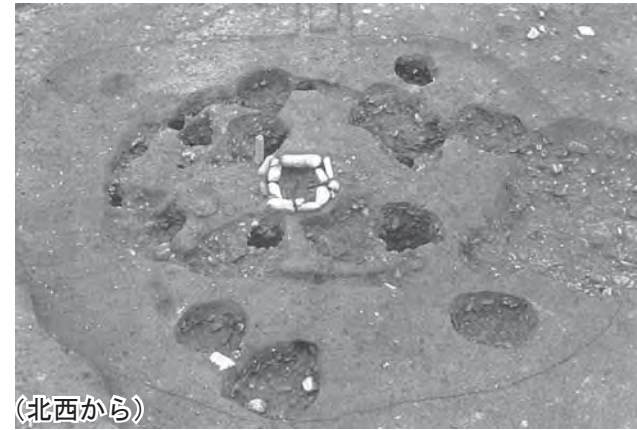
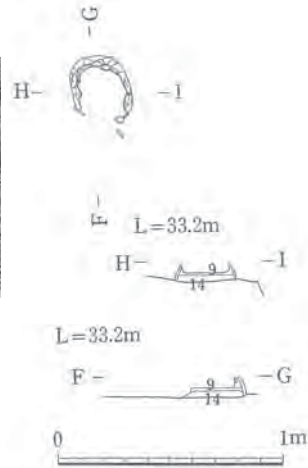

(北西から)

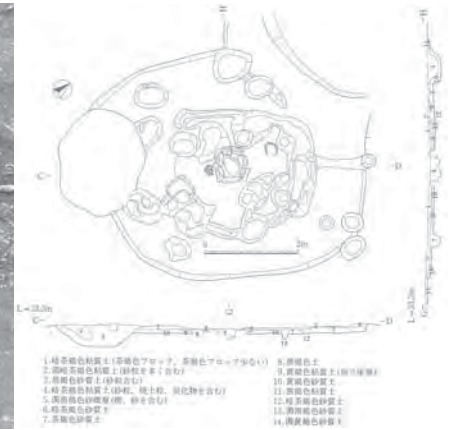

(北東から)

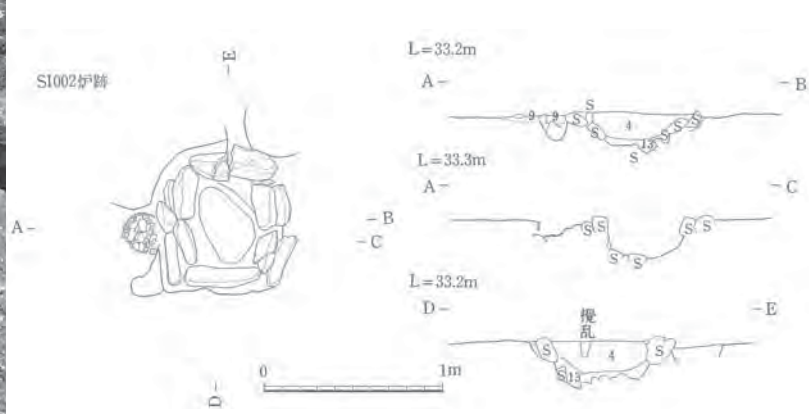

六橋遺跡
91SI002-44
『六橋遺跡』(1997)

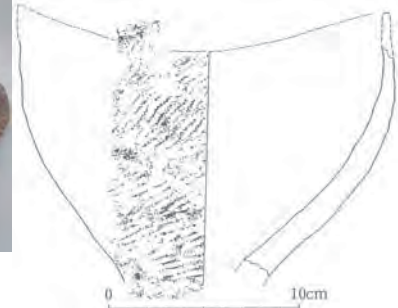
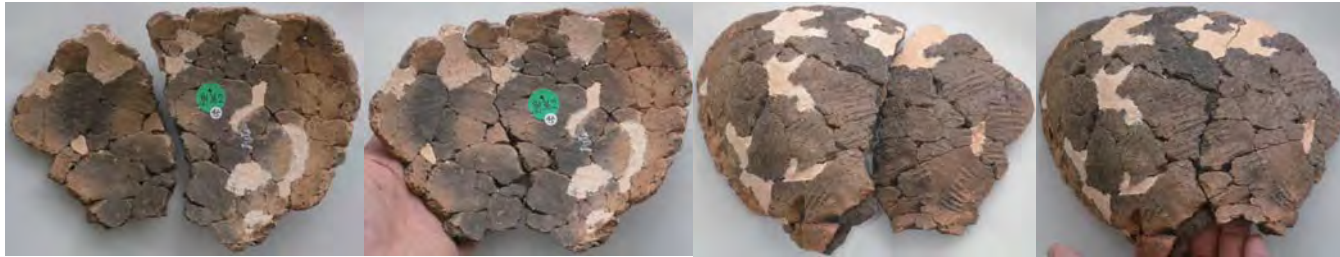

(土器実測図 : S=1/4)

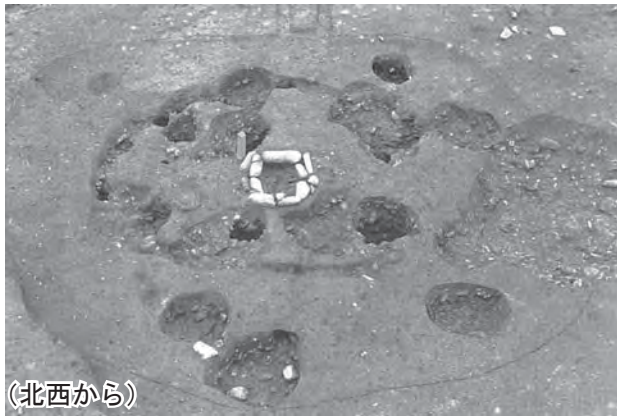

(北西から)



六橋遺跡
91SI002-45 (北東から)

『六橋遺跡』(1997)



- 1. 褐色黄色粘質土(茶褐色アロファ多い)
- 2. 黒味茶褐色粘質土(砂粒多(灰む))
- 3. 黒褐色粘質土(砂粒含む)
- 4. 粘茶褐色粘質土(砂粒、焼土跡、炭化物を含む)
- 5. 黒褐色粘質土(層、砂を含む)
- 6. 粘茶褐色粘質土
- 7. 茶褐色粘質土
- 8. 黒褐色土
- 9. 黄褐色粘質土(粘り強層)
- 10. 黄褐色粘質土
- 11. 茶褐色粘質土
- 12. 粘茶褐色粘質土
- 13. 黒褐色粘質土
- 14. 黄褐色粘質土

SI002炉跡

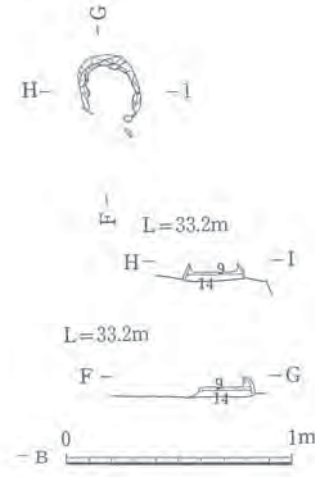
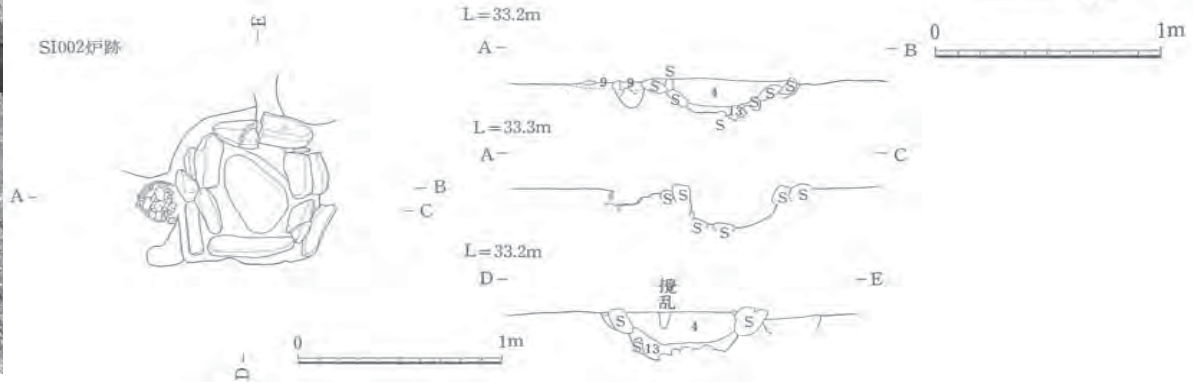

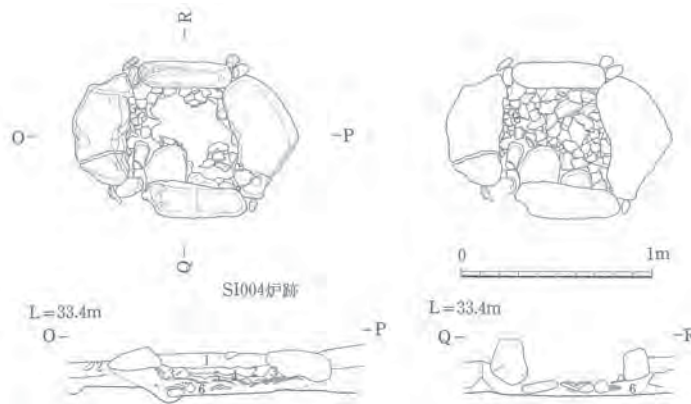
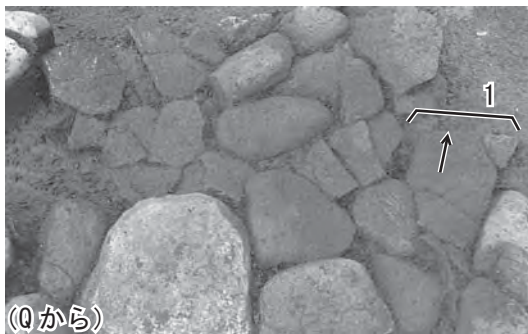

1. 黒灰褐色砂質土(炭化物含む)
2. 黒色粘質土(炭化物含む)
3. 暗茶褐色粘質土
4. 黄赤褐色粘土
5. 茶褐色砂質土
6. 黒灰色砂質土



(土器実測図 :S=1/10)

六橋遺跡
91SI004-99

『六橋遺跡』(1997)



炉奥側



(東)

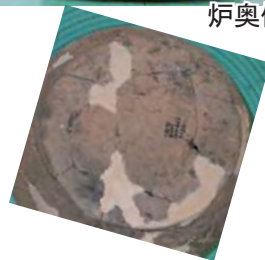
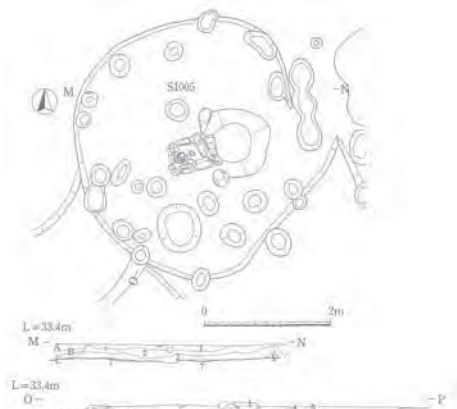

(南から)

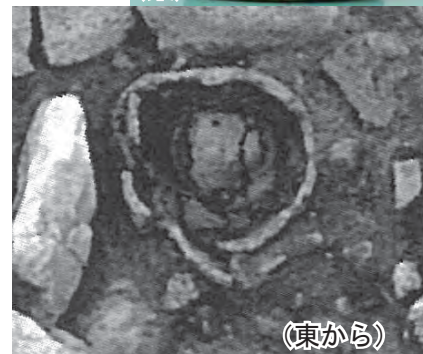

(東から)



(土器実測図 : S=1/6)

- 1. 茶褐色粘質土
- 2. 暗茶褐色砂質土 (炭化物をおびる炭化物、焼土含む)
- 3. 黒色砂質土 (炭化物を多量に含む)
- 4. 暗茶褐色粘質土 (炭化物を含むの2-3層ほど多い)
- 5. 茶褐色砂質土
- 6. 黒褐色粘質土 (炭化物を多く含む、3層ほど多く含まれている)
- 7. 茶褐色粘質土 (粘り強)



- 1. 黒色砂質土
- 2. 濁茶灰色砂質土 (炭化物、焼土をやや多く含む)
- 3. 濁黄茶灰色砂質土 (炭化物、焼土含む)
- 4. 黒色粘質土 (炭化物、焼土含む)

六橋遺跡
91SI005-105

『六橋遺跡』(1997)



(北から)

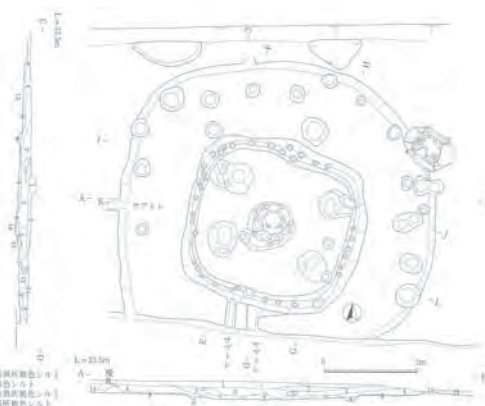

- 1. 湖東所産色少中
- 2. 湖東所産色少中
- 3. 湖東所産色少中
- 4. 湖東所産色少中
- 5. 湖東所産色少中
- 6. 湖東所産色少中
- 7. 湖東所産色少中
- 8. 湖東所産色少中
- 9. 湖東所産色少中
- 10. 湖東所産色少中
- 11. 湖東所産色少中
- 12. 湖東所産色少中
- 13. 湖東所産色少中
- 14. 湖東所産色少中
- 15. 湖東所産色少中
- 16. 湖東所産色少中
- 17. 湖東所産色少中
- 18. 湖東所産色少中
- 19. 湖東所産色少中
- 20. 湖東所産色少中

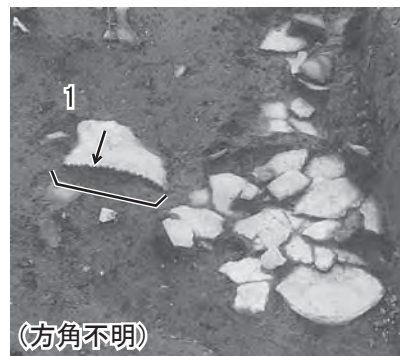

(方角不明)



(土器実測図 : S=1/10)

六橋遺跡
91SI008-228

『六橋遺跡』(1997)



(土器実測図 : S=1/6)



六橋遺跡
中期 60 図 241

『六橋遺跡』(1997)

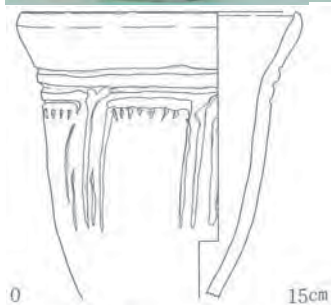

(土器実測図 : S=1/4)



笠舞遺跡
図 23-22

『金沢市笠舞遺跡』(1981)

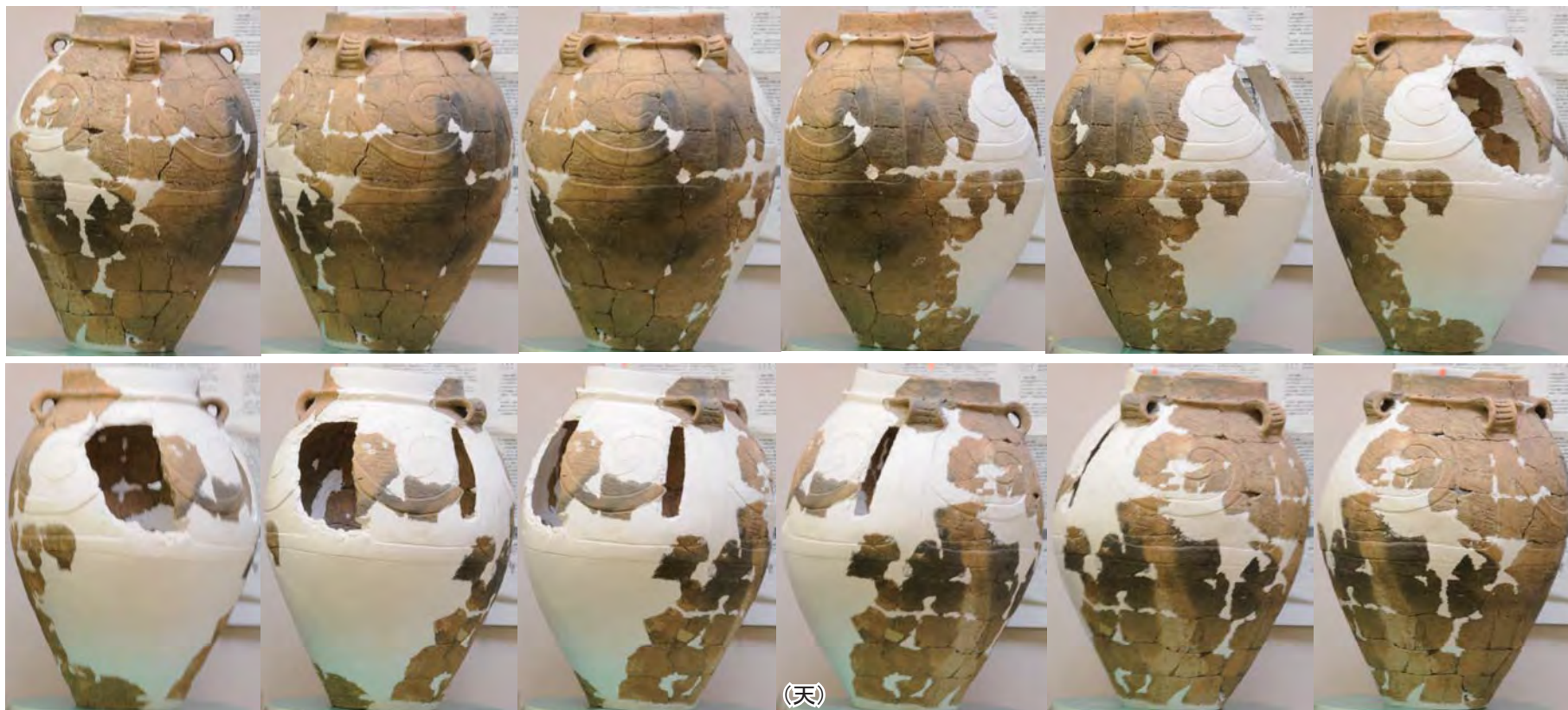

《方角不明》



《方角不明》



《方角不明》

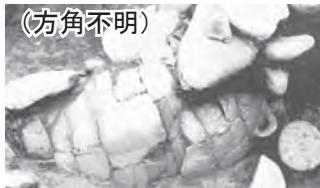

《方角不明》



《方角不明》



《方角不明》(土器実測図：S=1/12)

笠舞遺跡
図 26-1(3号住居)

『金沢市笠舞遺跡』(1981)

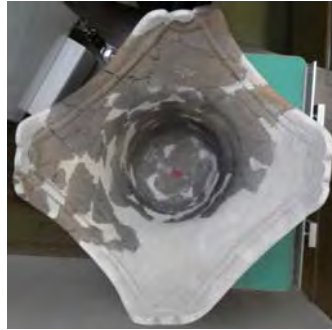

(土器実測図 : S=1/8)



笠舞遺跡
図 36-5(21号住居)
『金沢市笠舞遺跡』(1981)



(天)



(土器実測図 : S=1/8)



(方角不明)

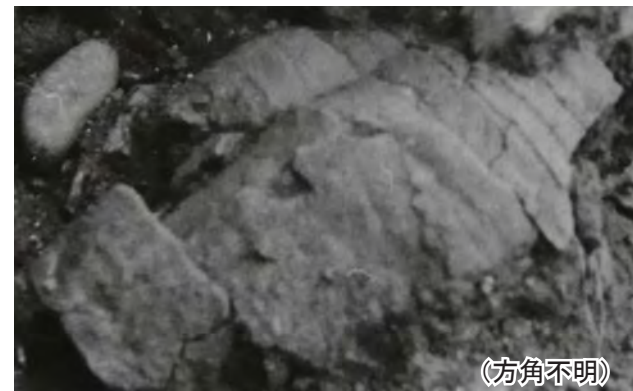

(方角不明)

笠舞遺跡
 図 40-8(2号住居)
 『金沢市笠舞遺跡』(1981)

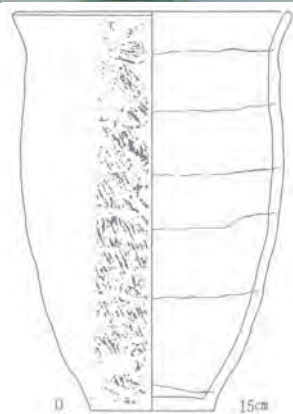
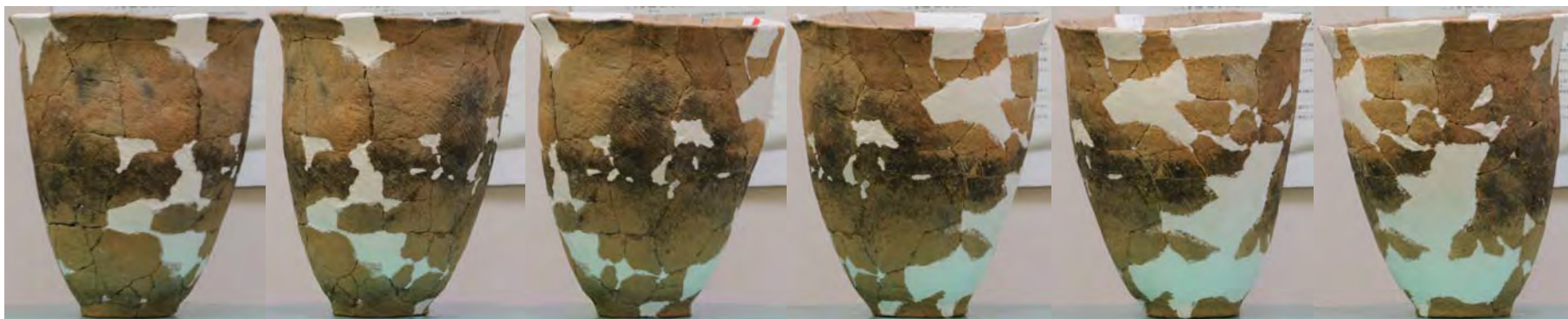

(土器実測図 : S=1/6)



笠舞遺跡
図 43-2

『金沢市笠舞遺跡』(1981)

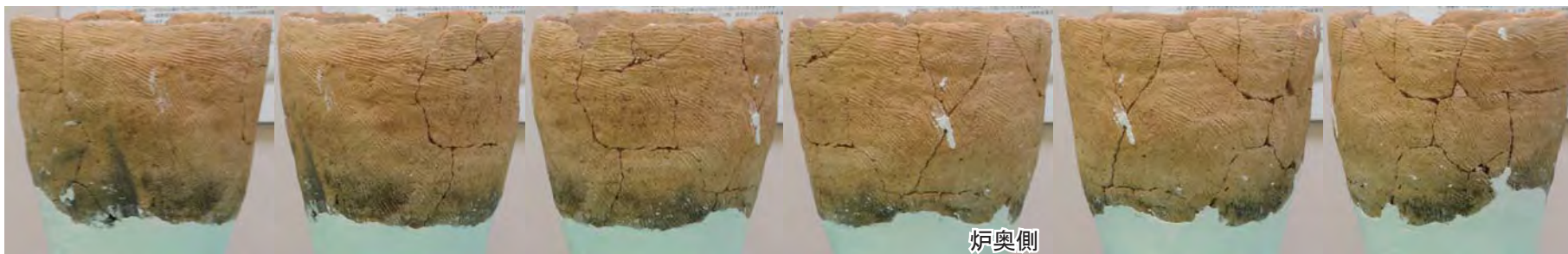

炉奥側

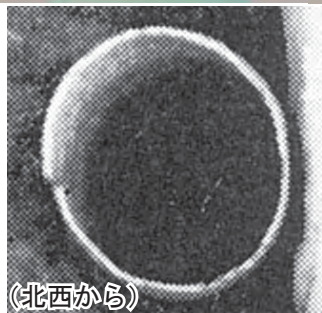

(北西から)

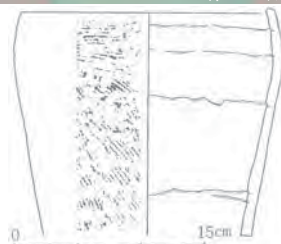

(土器実測図 : S=1/6)



(北)



(東から)

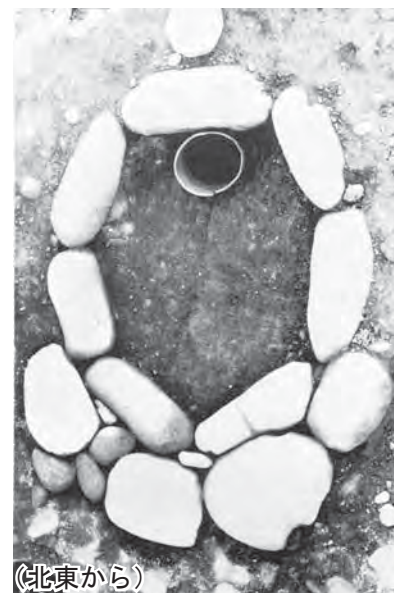
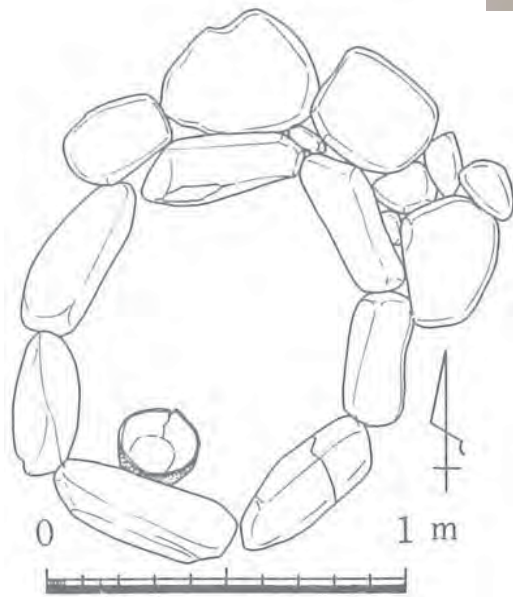

(北東から)

笠舞遺跡
 図 44-16 (1号住居炉内埋設土器)
 『金沢市笠舞遺跡』(1981)

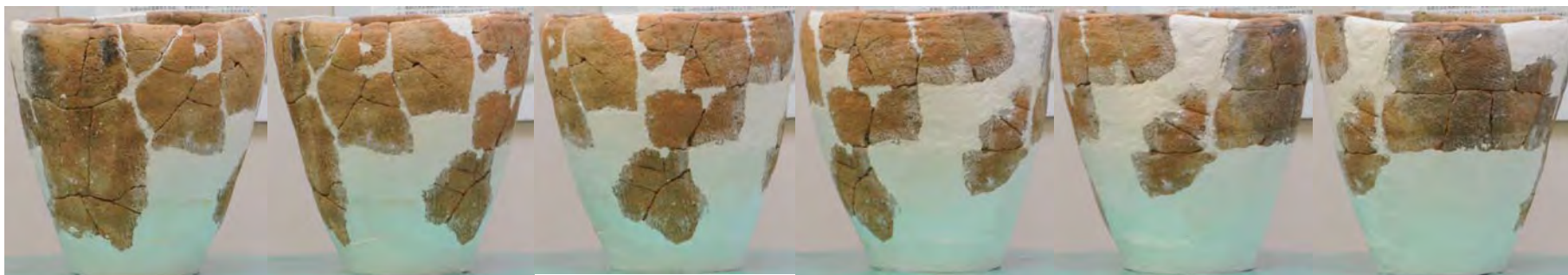

(土器実測図：S=1/4)



笠舞遺跡
図 45-19

『金沢市笠舞遺跡』(1981)

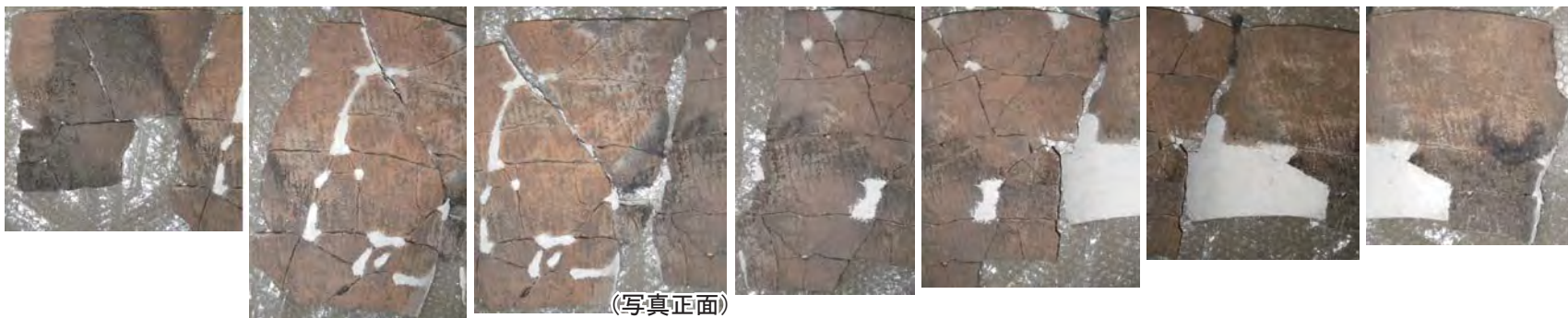

(写真正面)

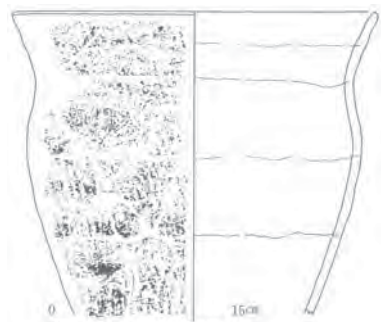

(土器実測図 : S=1/6)



(方角不明)



(南西から)

笠舞遺跡
図 46-1(10号住居)
『金沢市笠舞遺跡』(1981)



0 15cm

(土器実測図 : S=1/4)

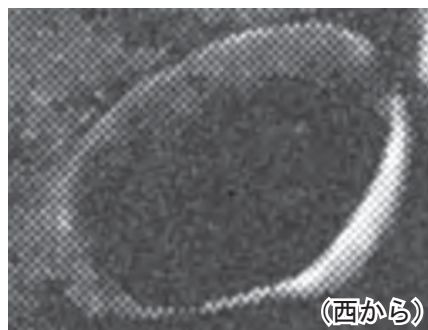

(西から)

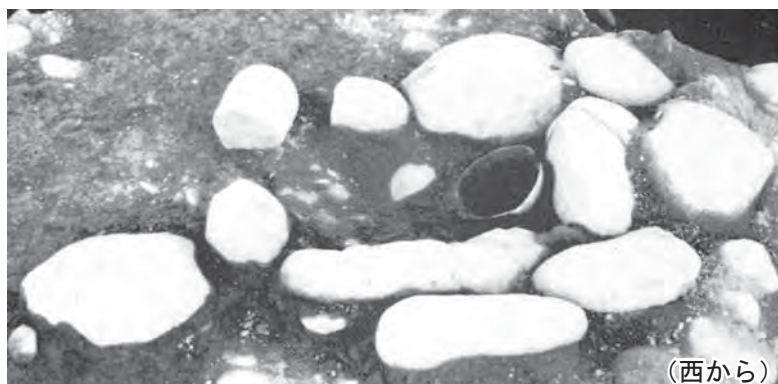

(西から)



(南西から)

笠舞遺跡
 図 46-3 (10号住居炉内)
 『金沢市笠舞遺跡』(1981)

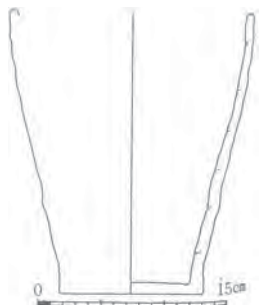

(土器実測図 : S=1/6)



笠舞遺跡
図 49-4

『金沢市笠舞遺跡』(1981)

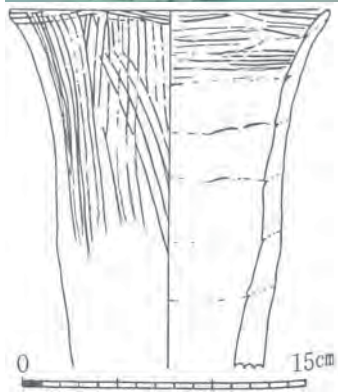

(土器実測図：S=1/4)

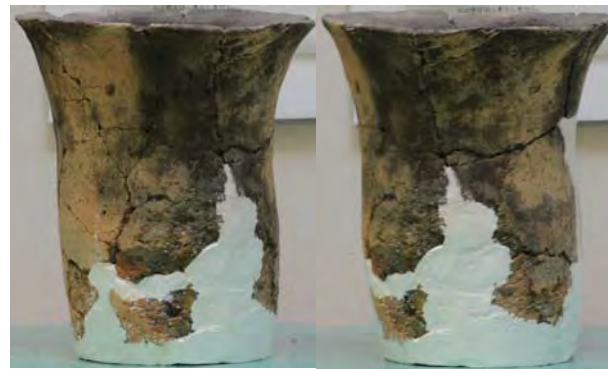

笠舞遺跡
図 49-13

『金沢市笠舞遺跡』(1981)

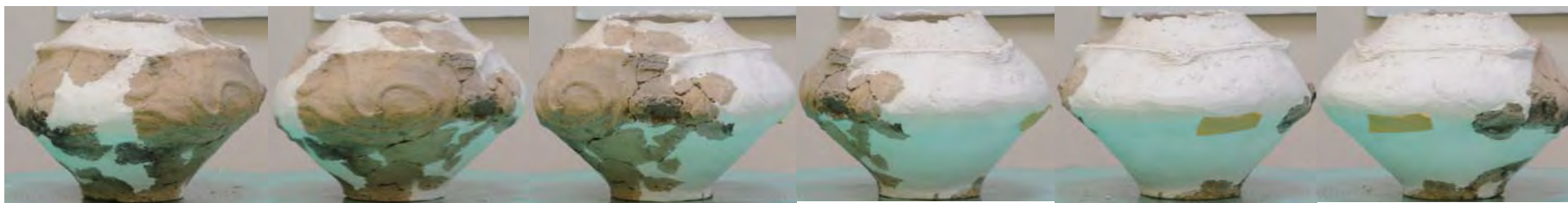

(土器実測図 : S=1/4)



笠舞遺跡

図 54-1 (15 号住居炉上)

『金沢市笠舞遺跡』(1981)

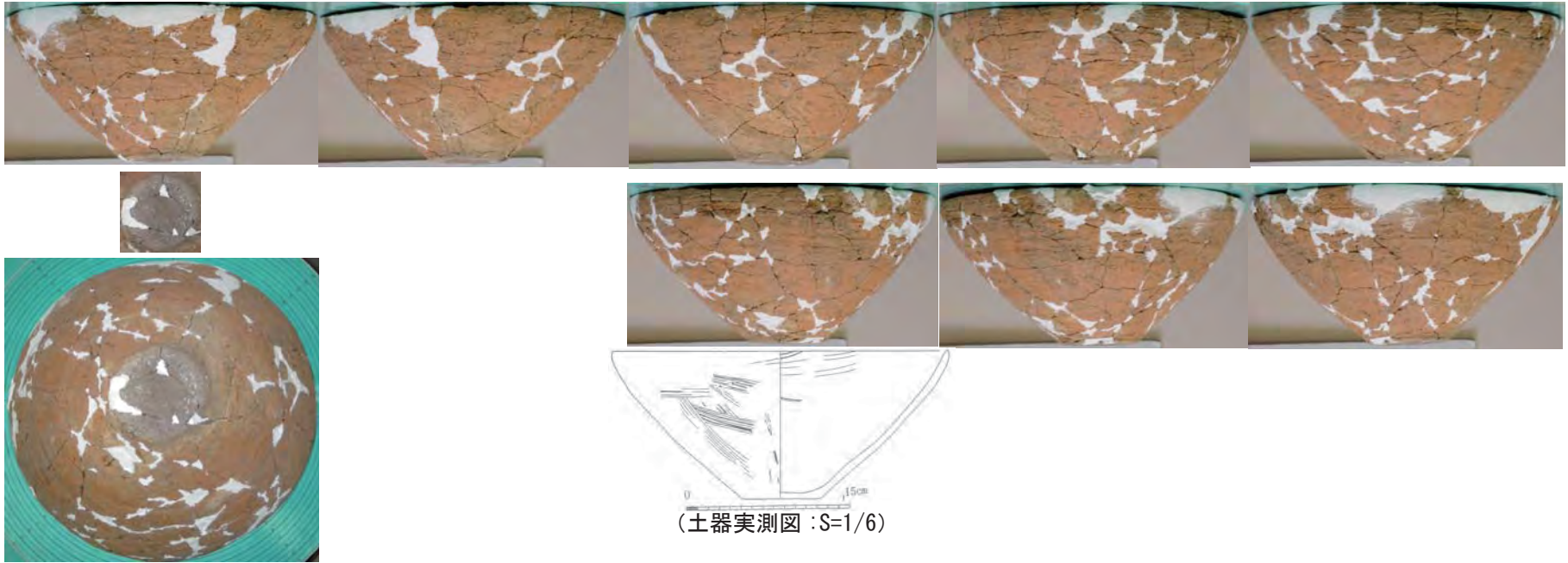

笠舞遺跡
 図 54-6(Pit)
 『金沢市笠舞遺跡』(1981)



笠舞遺跡
図 57-9

『金沢市笠舞遺跡』(1981)

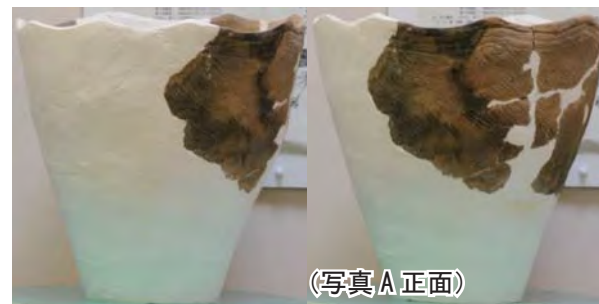

笠舞遺跡
図版 36-4 (1号住居)
『金沢市笠舞遺跡』(1981)

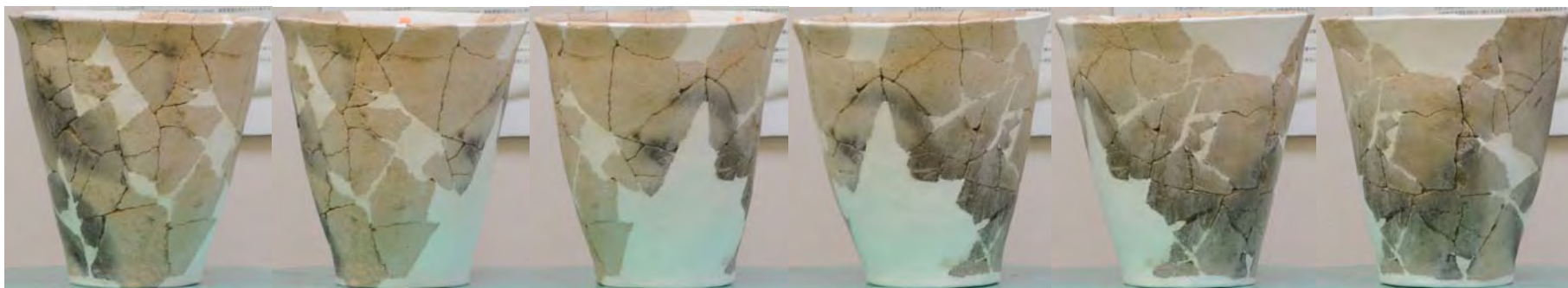

笠舞遺跡
図版 38-3 (21 号住居)
『金沢市笠舞遺跡』(1981)

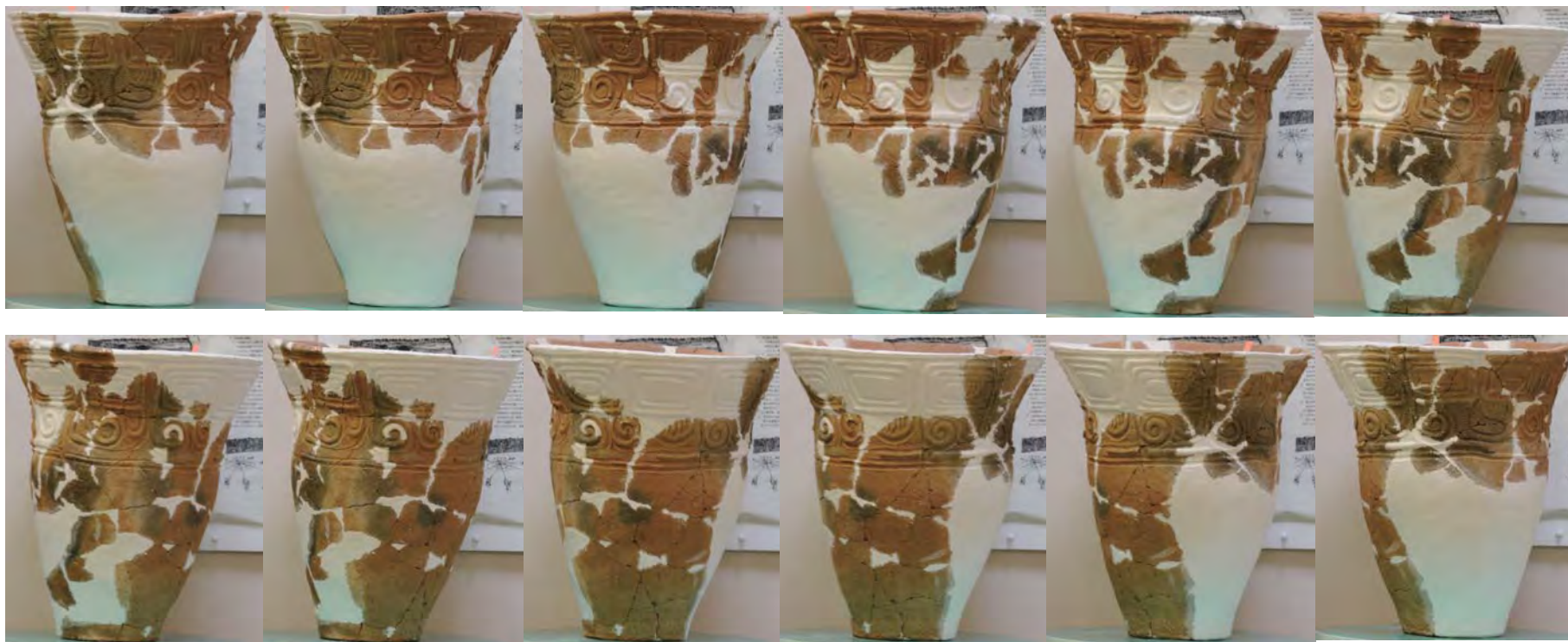

(土器実測図 : S=1/8)



(方角不明)

笠舞遺跡
図 27-1 土器敷

『金沢市笠舞遺跡』(1981)

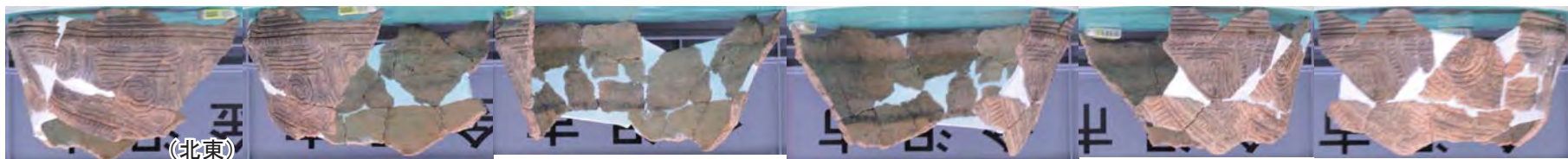

(北東)



(土器実測図 : S=1/6)



(北東から)

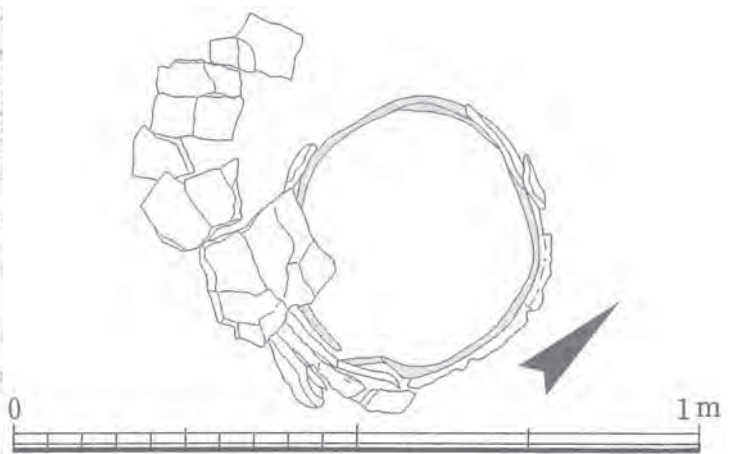

笠舞 A 遺跡
D3-58 埋甕
『笠舞 A 遺跡』(2001)

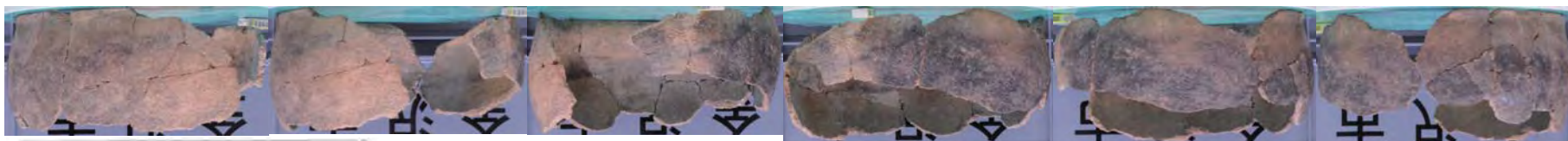

(土器実測図 : S=1/6)

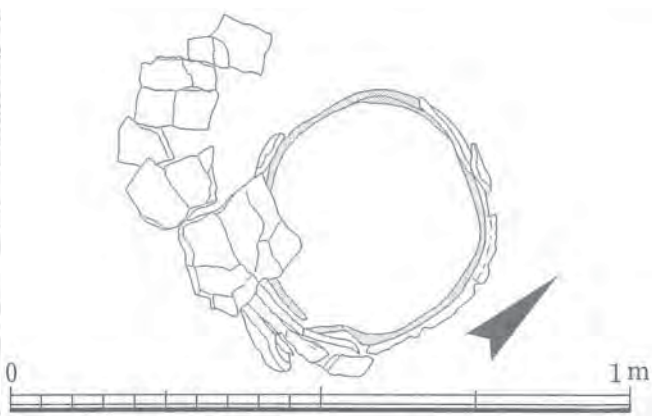

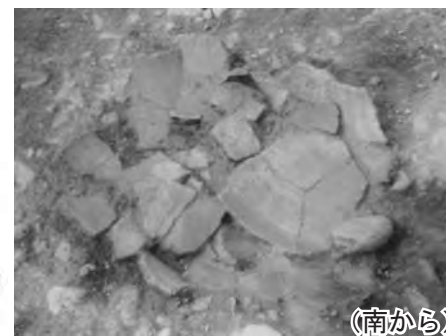
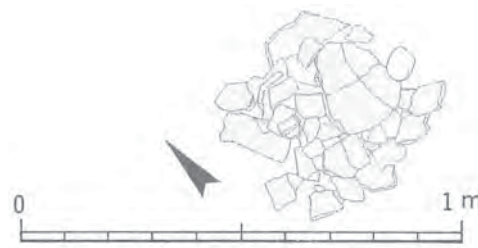
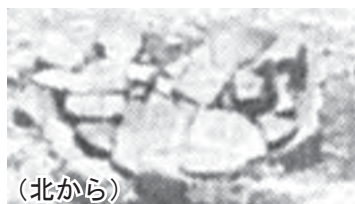
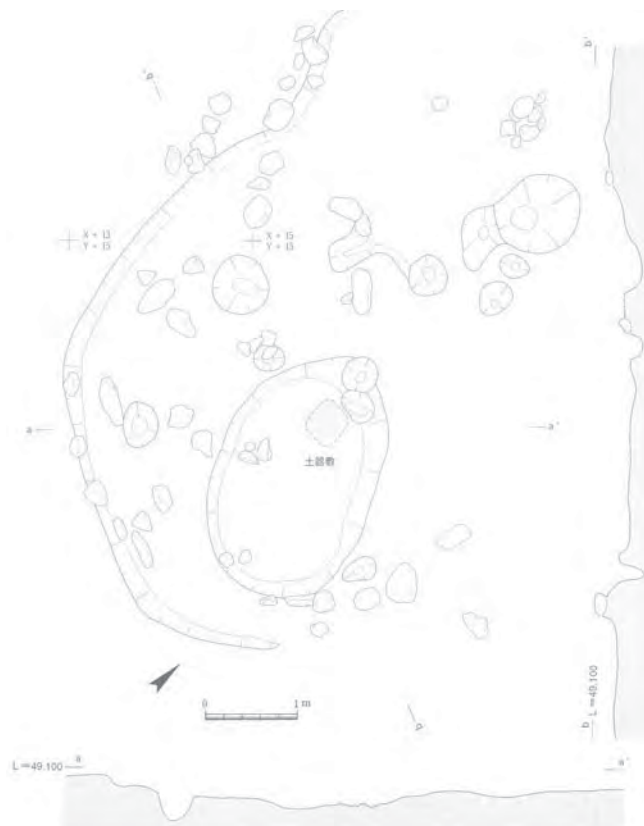
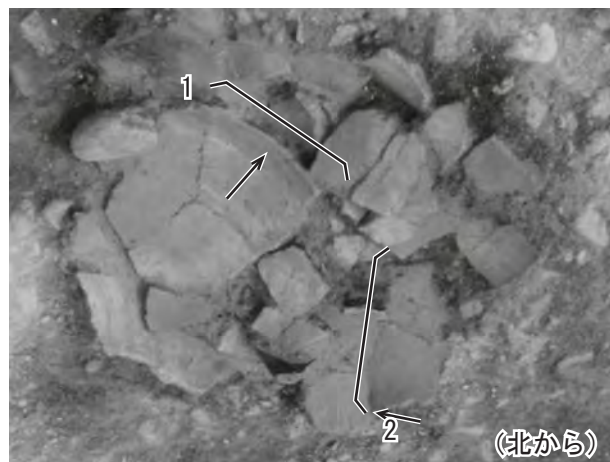

笠舞 A 遺跡
ST01-1 炉敷
『笠舞 A 遺跡』(2001)

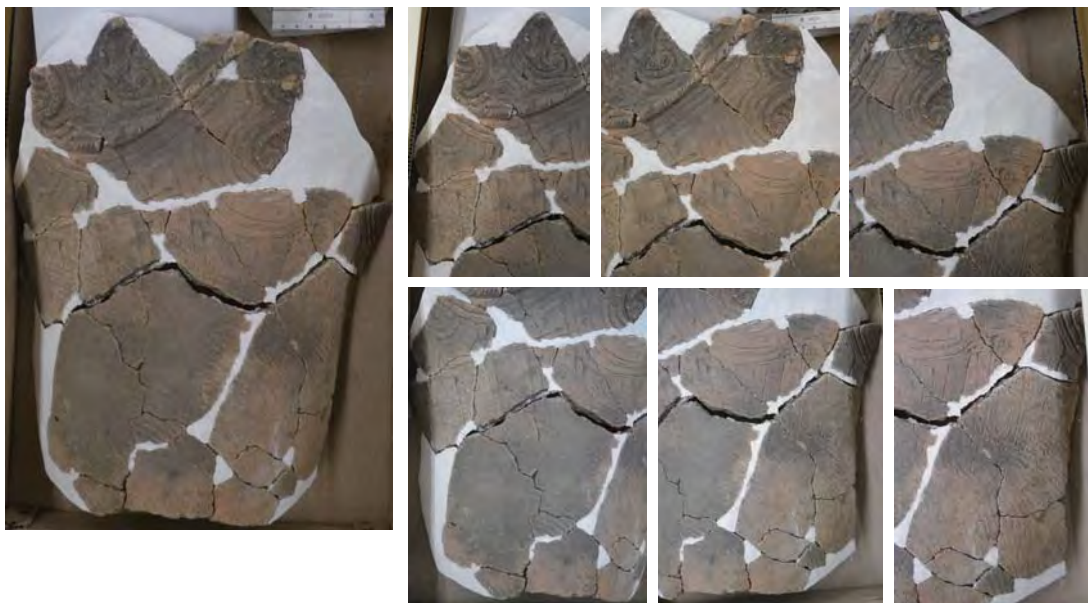

(土器実測図 : S=1/8)

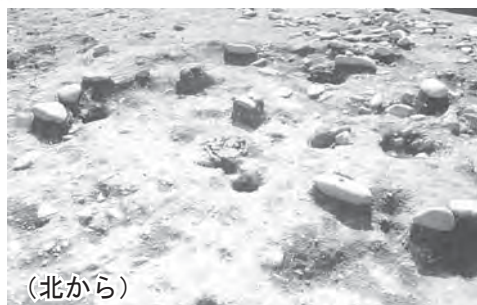

(北から)



1 m



(北から)

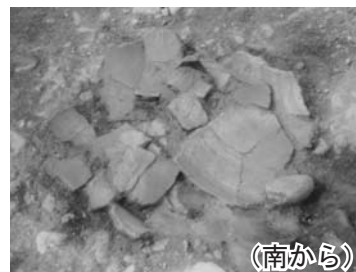

(南から)

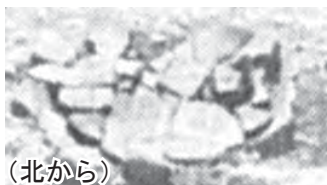

(北から)

笠舞 A 遺跡
ST01-2 炉敷

『笠舞 A 遺跡』(2001)



(土器実測図 : S=1/6)



(南東から)

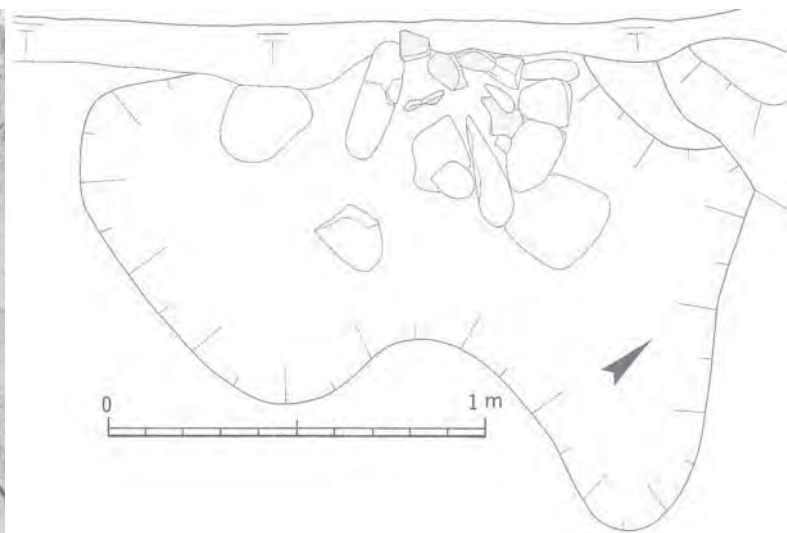

笠舞 A 遺跡
ST03-4

『笠舞 A 遺跡』(2001)

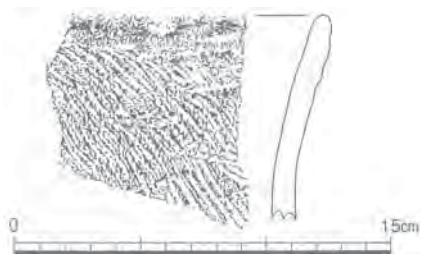
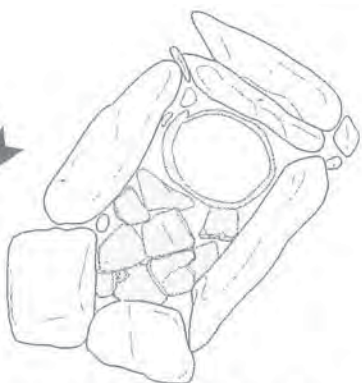
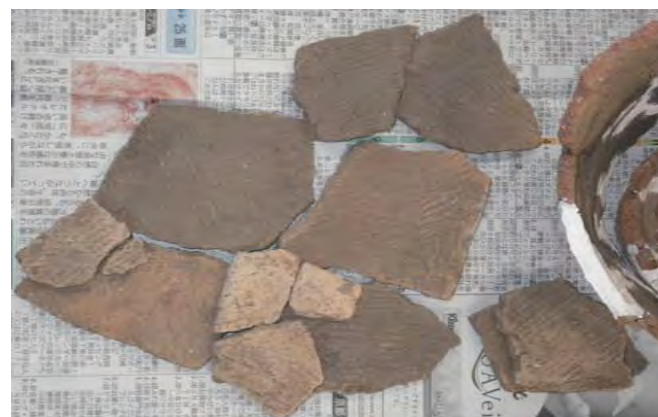

(土器実測図：S=1/6)

- ①暗褐色シルト質土 (固く締まる・焼土)
- ②褐色シルト質土

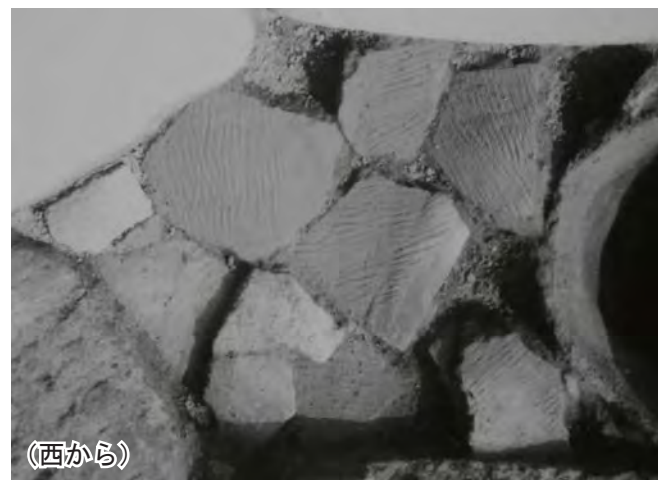

(西から)

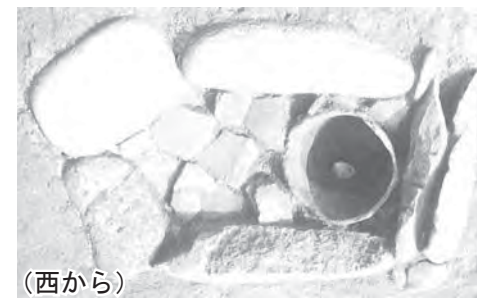

(西から)

笠舞 A 遺跡
ST06-12 土器敷

『笠舞 A 遺跡』(2001)

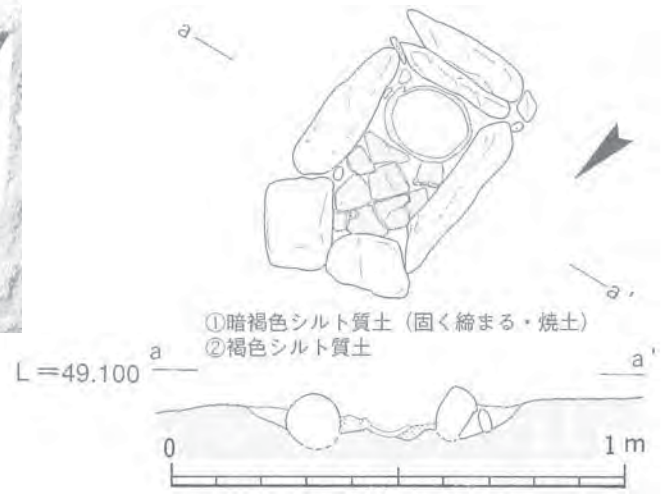
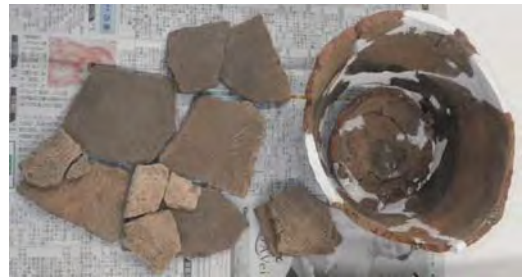
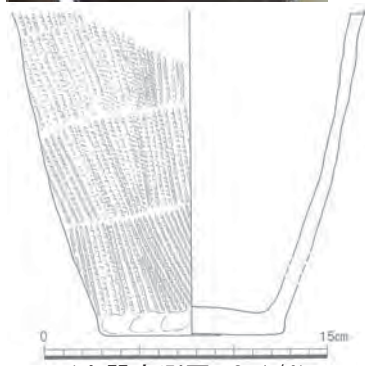
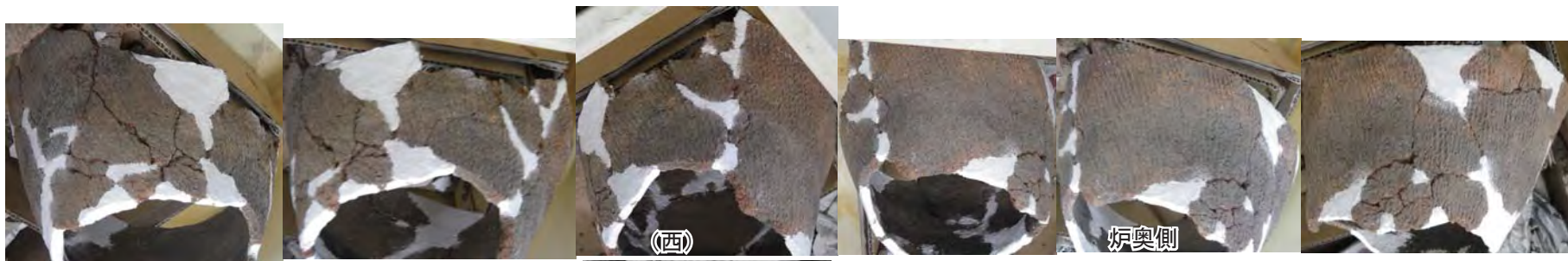

笠舞 A 遺跡
ST06-13 添炉
『笠舞 A 遺跡』(2001)



(北東から)

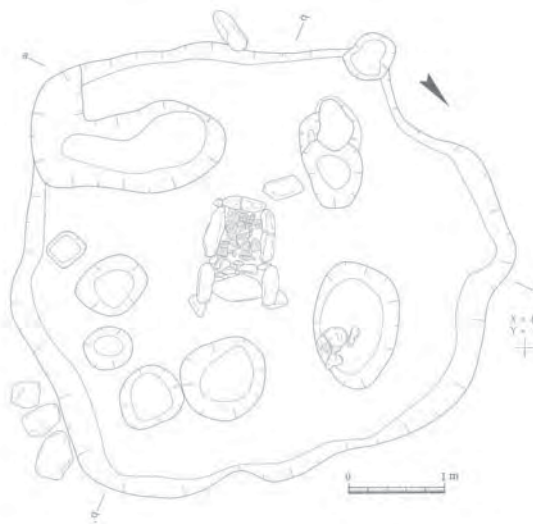

(土器実測図 : S=1/6)

笠舞 A 遺跡
ST08-38

『笠舞 A 遺跡』(2001)

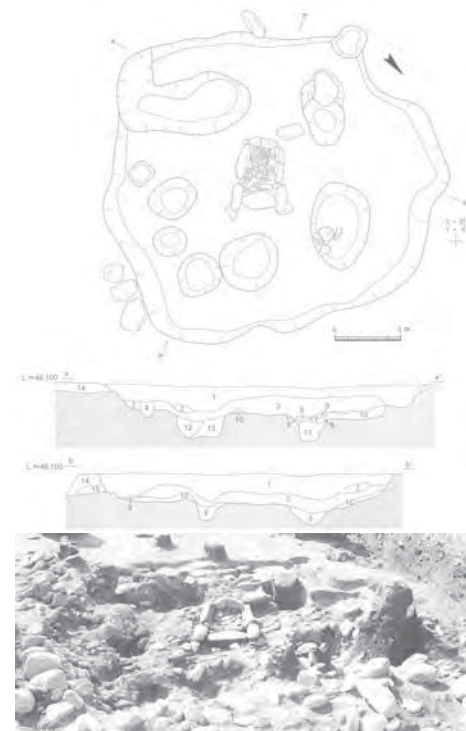
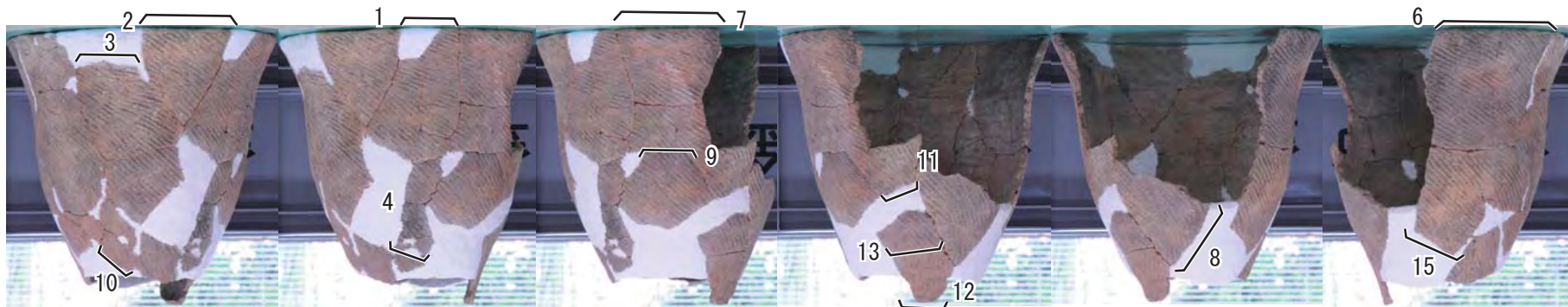

笠舞 A 遺跡
ST08-42 炉敷
『笠舞 A 遺跡』(2001) (北東から)

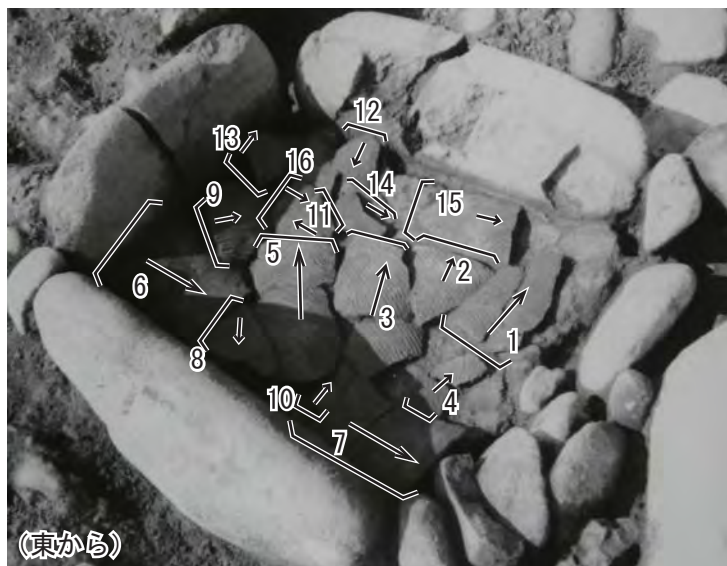

(東から)



(北東から)



(南東から)

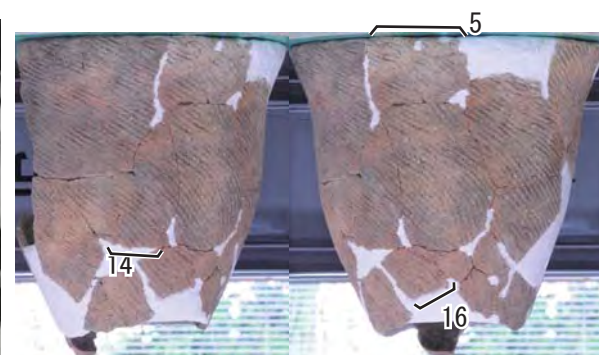

(土器実測図 : S=1/8)

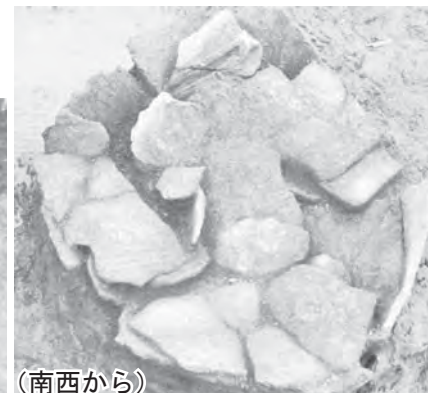
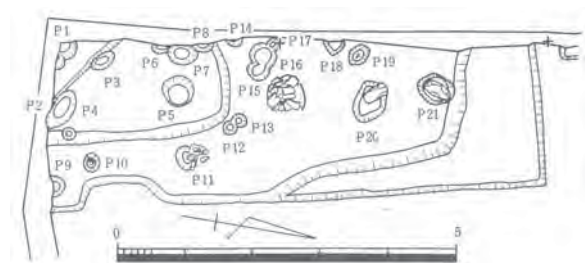
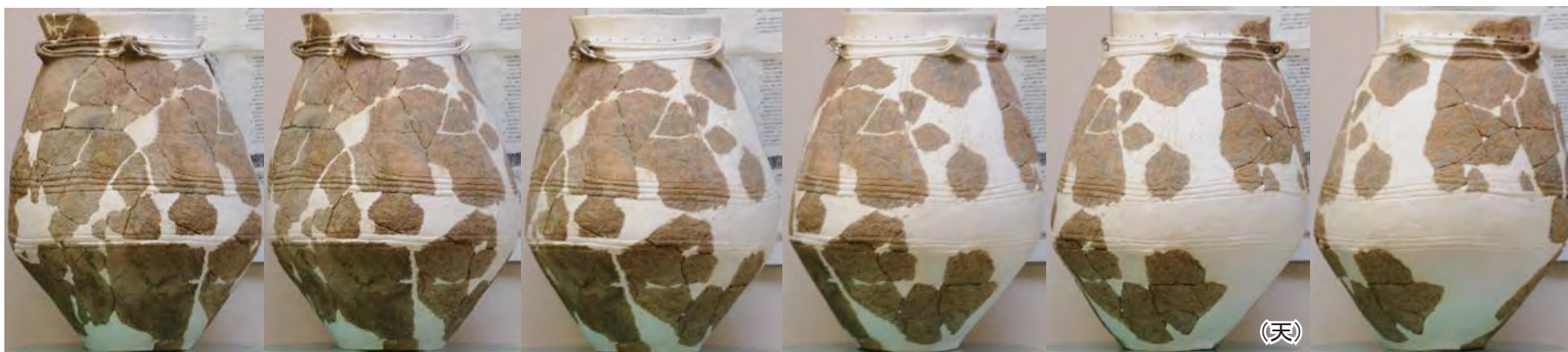

古府遺跡
1号住居 6 図 -2

『古府遺跡』(1974)

(土器実測図 : S=1/10)

(東から)

(南西から)

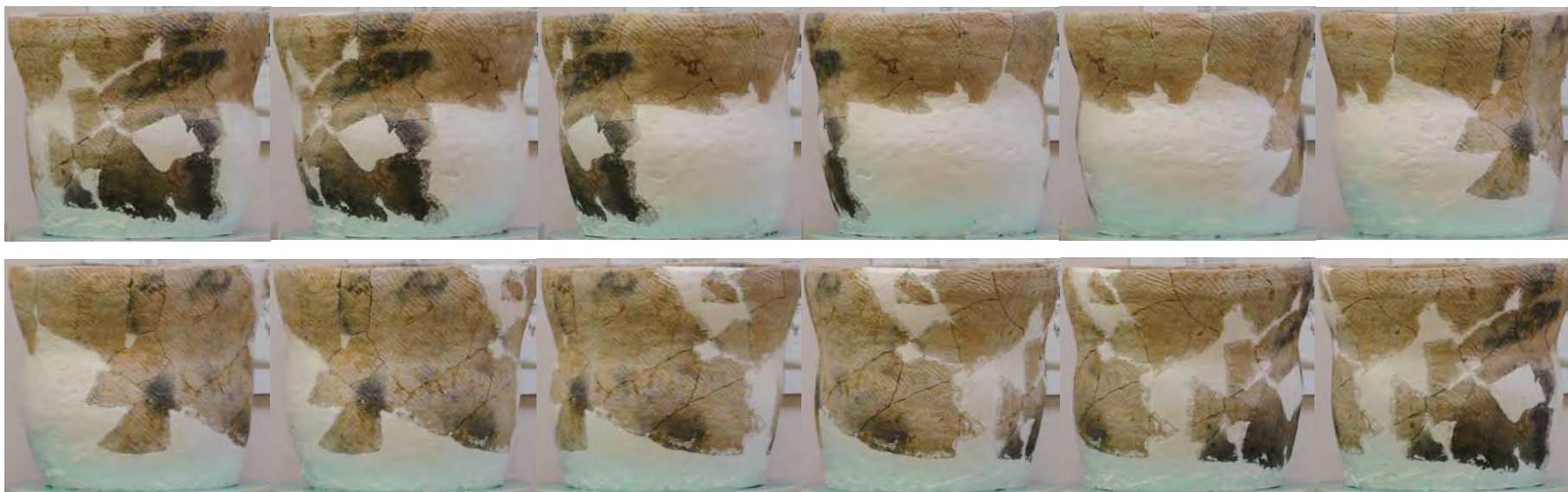

古府遺跡

『古府遺跡』(1974)

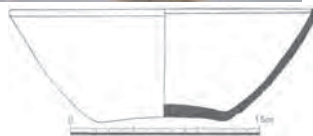
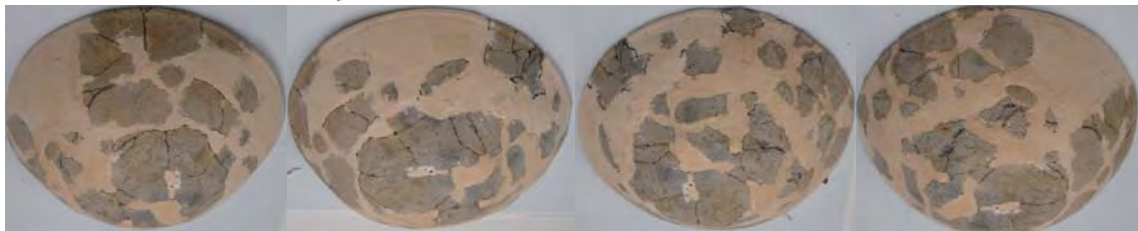

(土器実測図 : S=1/6)

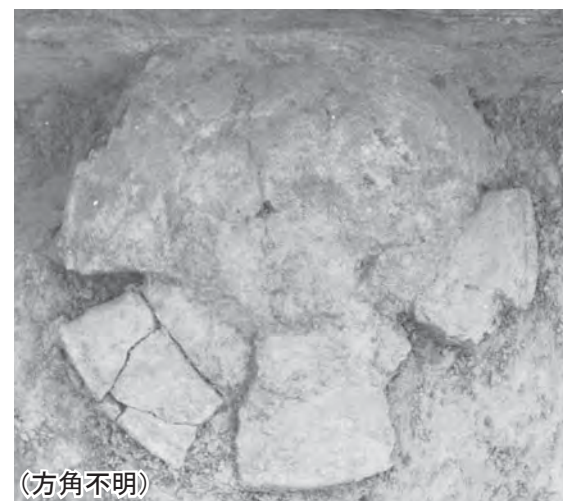

(方角不明)

古府遺跡
6 図 -1

『古府遺跡』(1974)

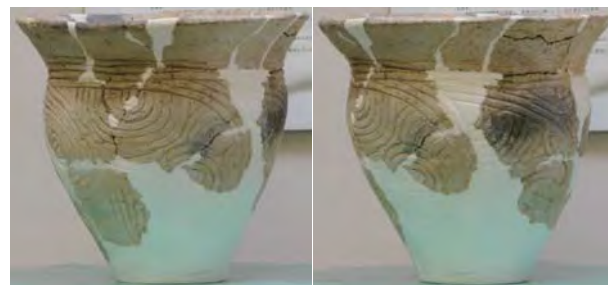
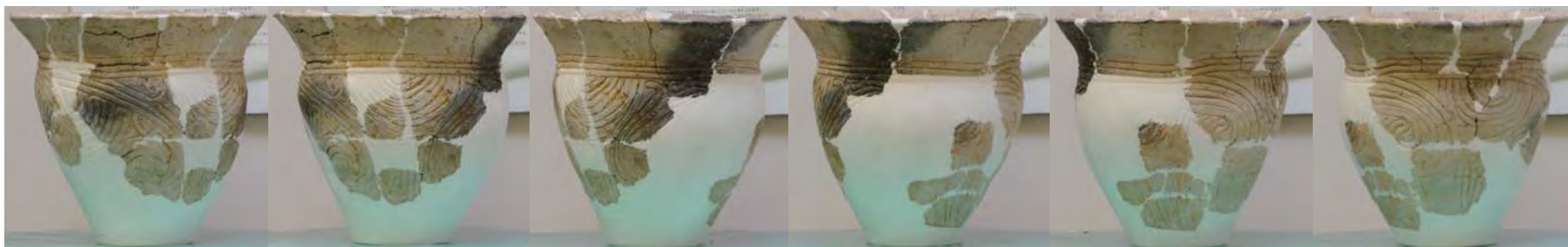

(土器実測図：S=1/6)

古府遺跡
19 図-11

『古府遺跡』(1974)



(土器実測図 : S=1/10)

上安原遺跡
1

『上安原遺跡』(2003)

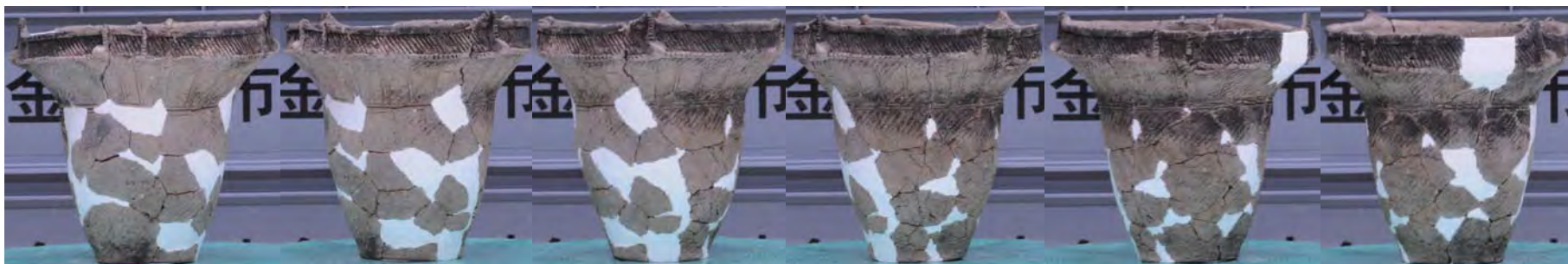

(土器実測図：S=1/6)



上安原遺跡
66

『上安原遺跡』(2003)

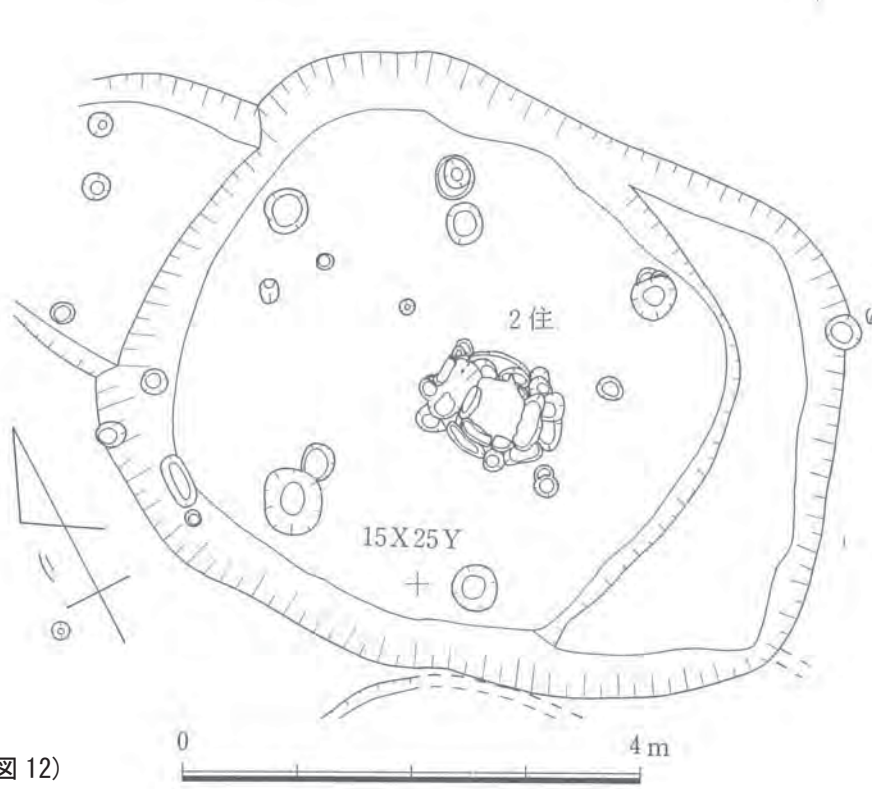
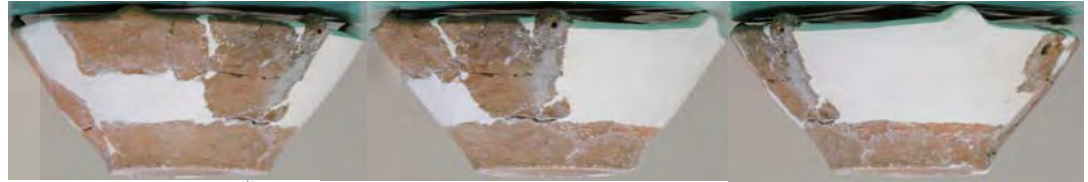

東市瀬遺跡
2号住居 (40 図 12)
『金沢市東市瀬遺跡』(1985)

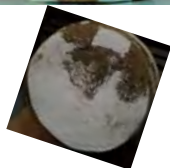
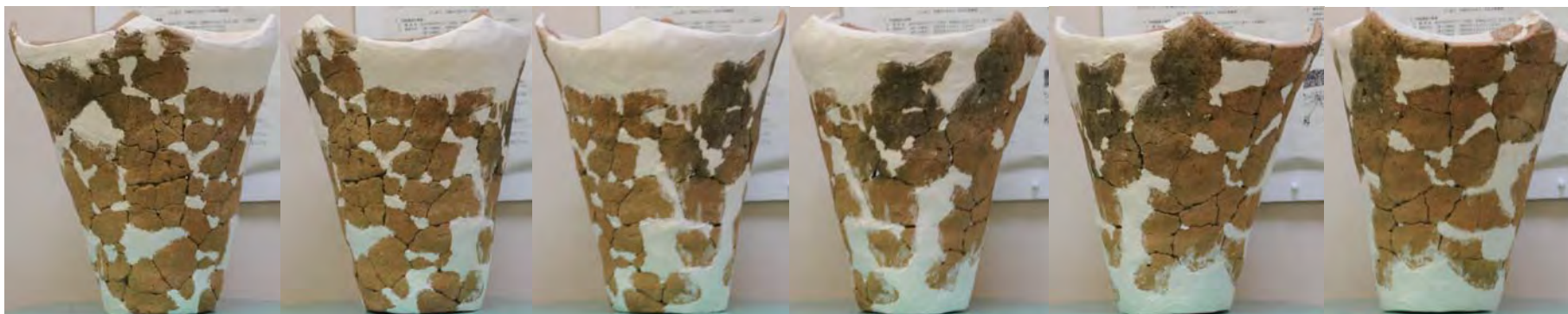

東市瀬遺跡
2号住居(105 図7)
『金沢市東市瀬遺跡』(1985)

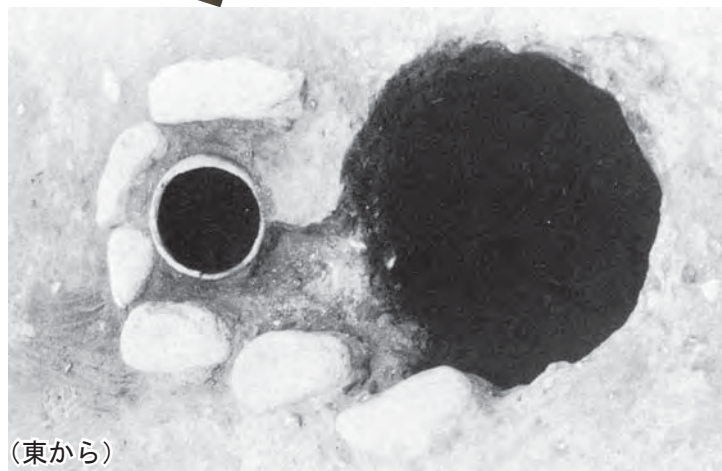

東市瀬遺跡
40号住居炉内埋設土器 (85 図 1)
『金沢市東市瀬遺跡』(1985)

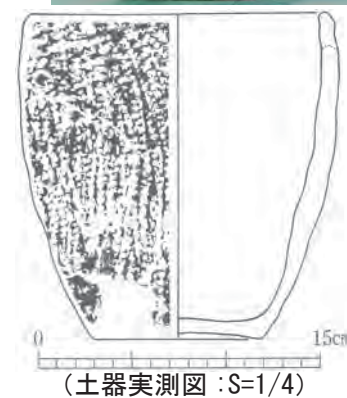
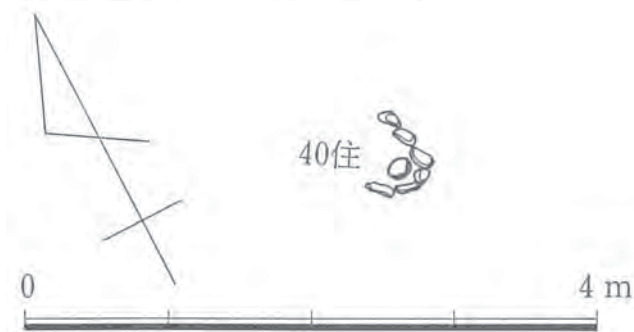
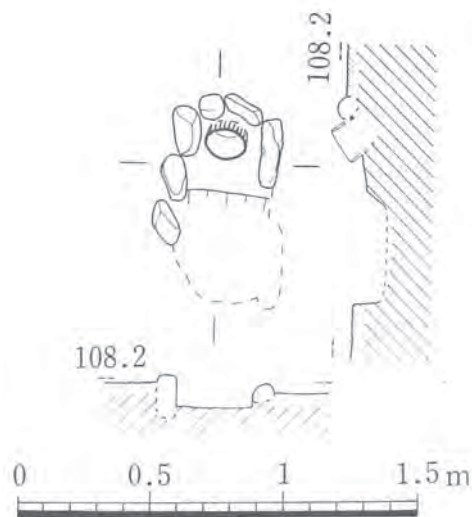

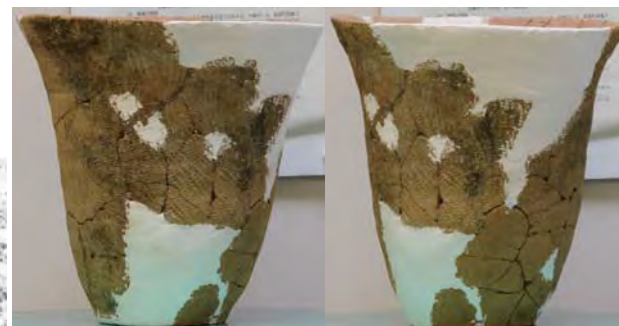
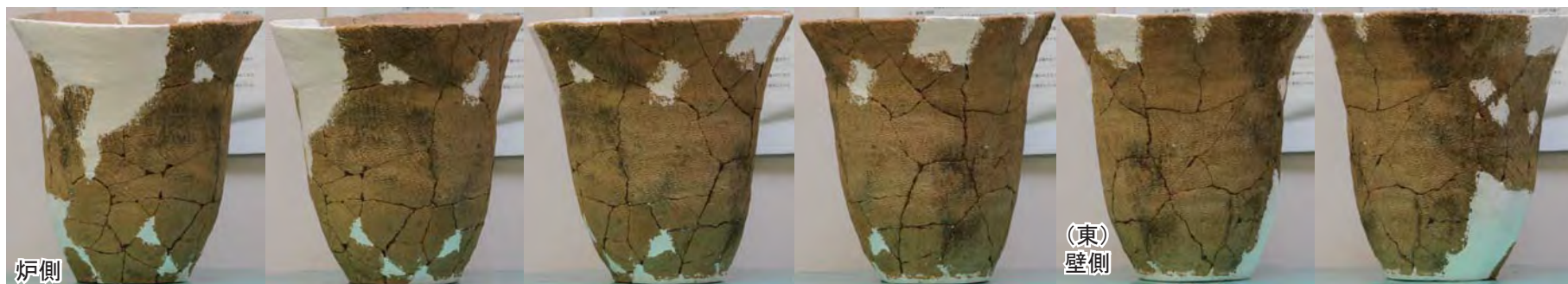

(土器実測図 : S=1/6)

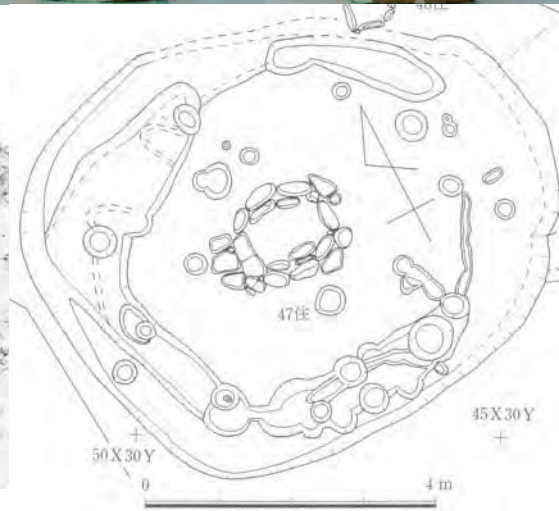
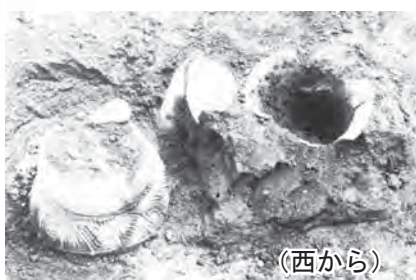

東市瀬遺跡
47号住居埋設土器 (54 図 14)

『金沢市東市瀬遺跡』(1985)



(北西)

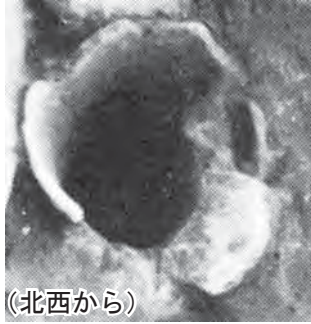

(北西から)



(北西から)



(北東)
炉側



(北東から)



(土器実測図 : S=1/4)

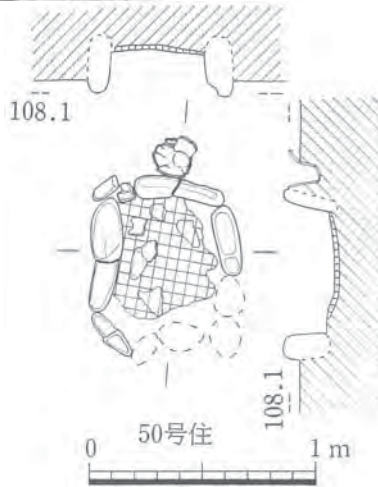
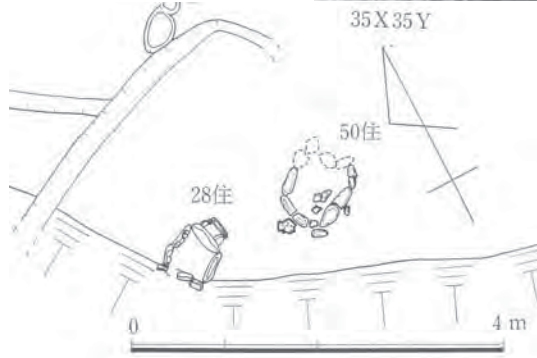

(北東から)

東市瀬遺跡
50号住居炉横埋設土器 (89 図 1)

『金沢市東市瀬遺跡』(1985)

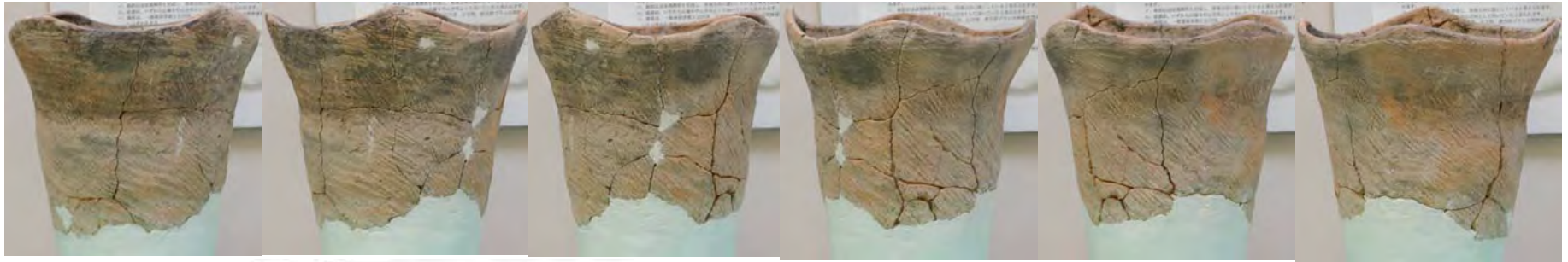

(土器実測図 : S=1/6)

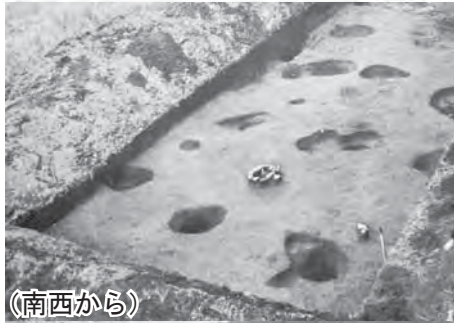
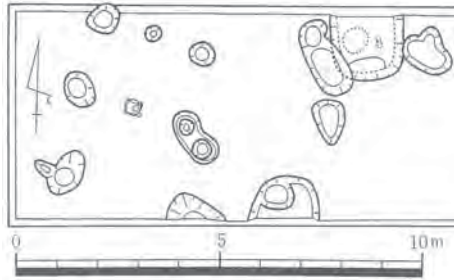

(南西から)



(北東から)

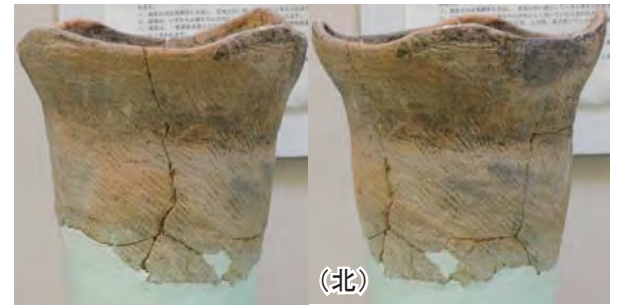

(北)

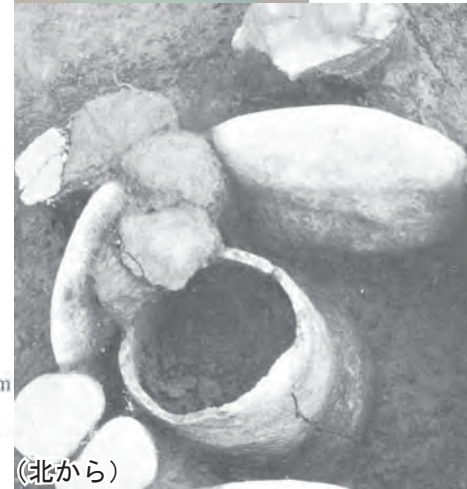

(北から)

北塚遺跡
1号炉 図 23-1

『北塚遺跡』(1977)

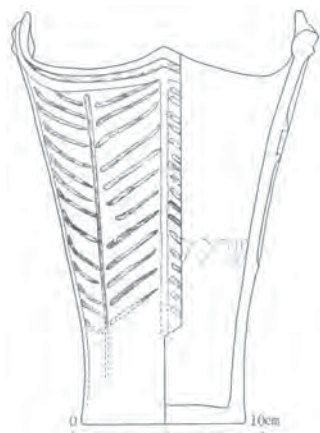

(土器実測図 : S=1/4)



北塚遺跡
図 13-1

『北塚遺跡』(1977)

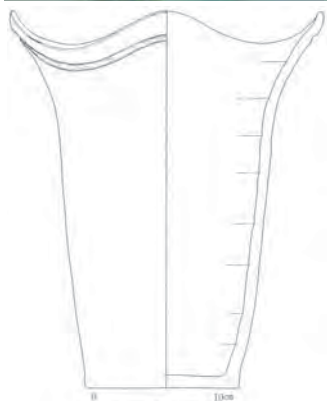

(土器実測図：S=1/6)



北塚遺跡
図 19-4

『北塚遺跡』(1977)



(南から)

北塚遺跡 14 次
2 号住居 63

『金沢市北塚遺跡』(1998)



(土器実測図 : S=1/8)

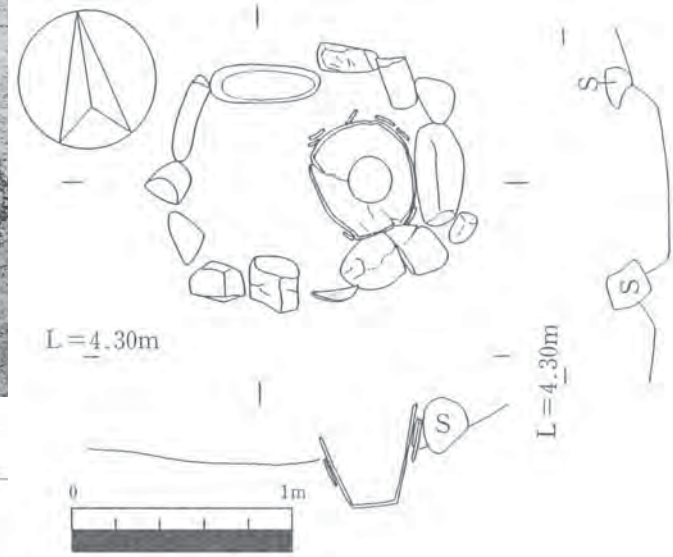
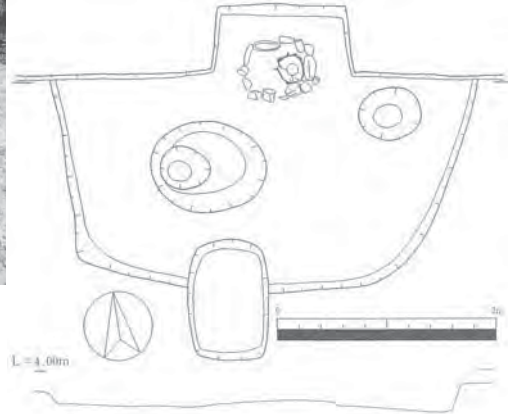

北塚遺跡 14 次
3 号住居 85
『金沢市北塚遺跡』(1998)

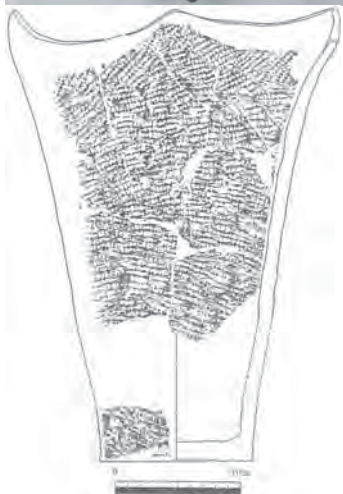

(土器実測図 : S=1/6)

北塚遺跡 14 次
177

『金沢市北塚遺跡』(1998)

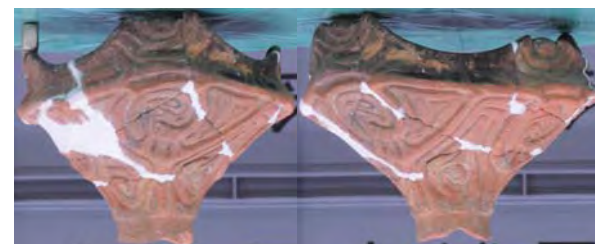
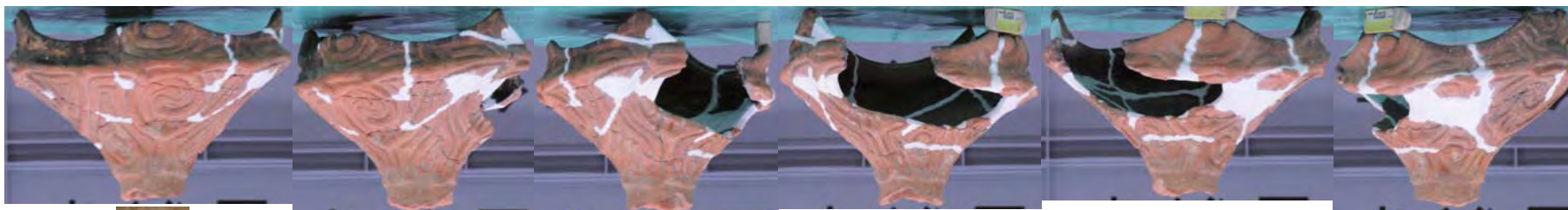

(土器実測図 : S=1/6)

北塚遺跡 14 次
376

『金沢市北塚遺跡』(1998)

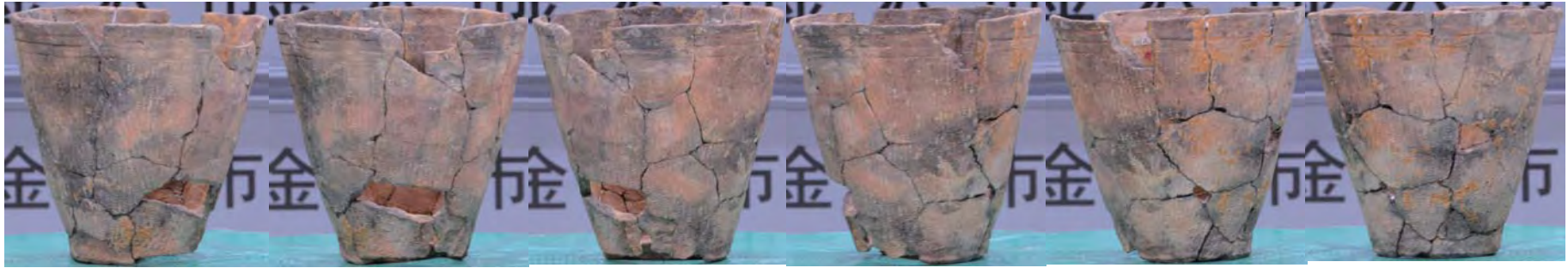

(土器実測図 : S=1/4)

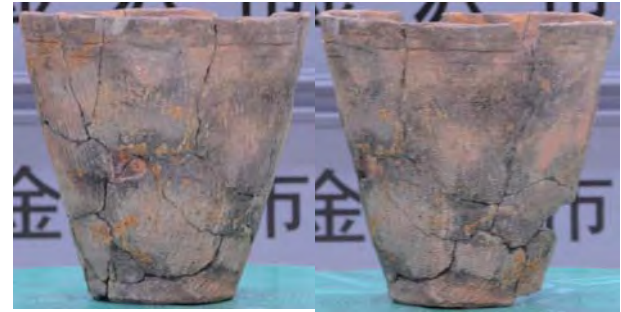

北塚遺跡 14 次
415

『金沢市北塚遺跡』(1998)

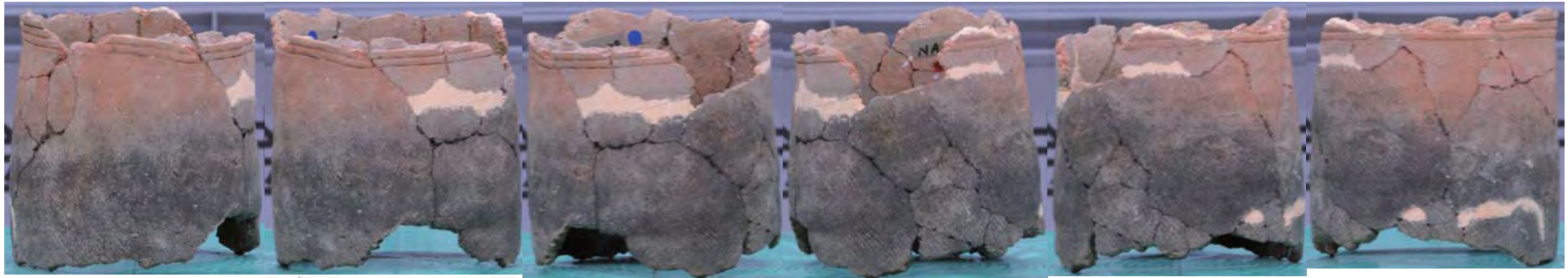

(土器実測図 : S=1/4)

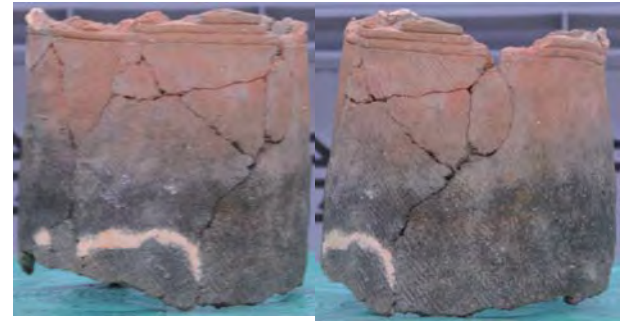

北塚遺跡 14 次
426

『金沢市北塚遺跡』(1998)



(土器実測図 : S=1/6)

北塚遺跡 14 次
SK18-116

『金沢市北塚遺跡』(1998)

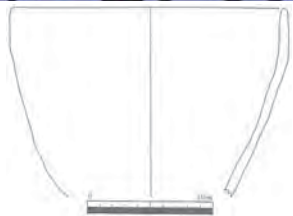
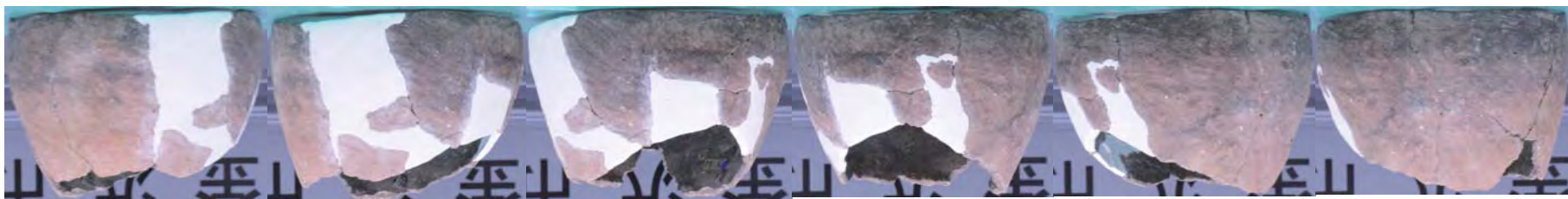

(土器実測図 : S=1/6)

