

## Experimental Study on Glacial Lake Outburst Floods Due to Waves Overtopping and Erosion of Moraine Dam

Ripendra AWAL, Hajime NAKAGAWA, Masaharu FUJITA, Kenji KAWAIKE,  
Yasuyuki BABA and Hao ZHANG

### Synopsis

Glacial lake outburst floods (GLOFs) may cause floods of great magnitudes in the downstream river reaches. About 80% of GLOFs (based on 20 cases with known failure mechanisms) were initiated by displacement waves from ice avalanches that collapsed into the lakes from hanging or calving glaciers and rock avalanches. Therefore, an integrated model is essential for the i) prediction of waves generated by ice/rock avalanche, ii) prediction of outflow hydrograph due to waves overtopping and erosion of moraine dam and iii) flow and sediment routing in the downstream for flood risk assessment. Toward development of an integrated model, this study focuses on experimental study of moraine dam failure due to waves overtopping and erosion. Extensive laboratory experiments are carried out by varying size of ice/rock avalanche, shape of the dam, dam material and lake water level. The outflow hydrographs produced by waves overtopping and erosion consist multiple peaks. For the same falling block and lake water level, the initial peaks are similar for both triangular and trapezoidal dams. However, magnitude and timing of subsequent peaks are different according to dam shapes and dam materials.

**Keywords:** GLOF, waves overtopping, erosion, outflow hydrograph, laboratory experiment

### 1. Introduction

Glacial lake outburst flood (GLOF) is a release of an enormous amount of stored water in the glacial lake due to failure or breach of ice or moraine dam. Moraine dam failure and GLOF are phenomena closely related to climate change. These events may cause floods of great magnitudes, loss of life, properties and sediment disaster in the downstream river reaches. Moraine dammed lakes and GLOFs are common in different glacierized regions of the world (Lliboutry et al., 1977; Haeberli, 1983; Costa and Schuster, 1988; Yamada, 1998; Clague and Evans, 2000; Richardson and Reynolds, 2000). In the Himalaya, a study carried out jointly by International Centre for Integrated Mountain Development (ICIMOD), United Nations

Environment Programme/Regional Resource Centre for Asia and the Pacific (UNEP/RRC-AP) and Asia-Pacific Network for Global Change research (APN) between 1999 and 2003 estimated about 9000 glacial lakes and more than 200 potentially dangerous glacial lakes (see Table 1) in Bhutan, Nepal, Pakistan and selected basins of China and India (Bajracharya et al., 2008). Thus monitoring of glaciers, glacial lakes, installation of early warning systems and different hazard mitigation measures are required for proper management of potential GLOF events.

Moraine dams are distinct ridges and mounds of debris lay down directly by a glacier or pushed up by it at the point of its greatest progress. Some moraine dams contain dead glacier ice. A lake formed as a glacier recedes from its terminal

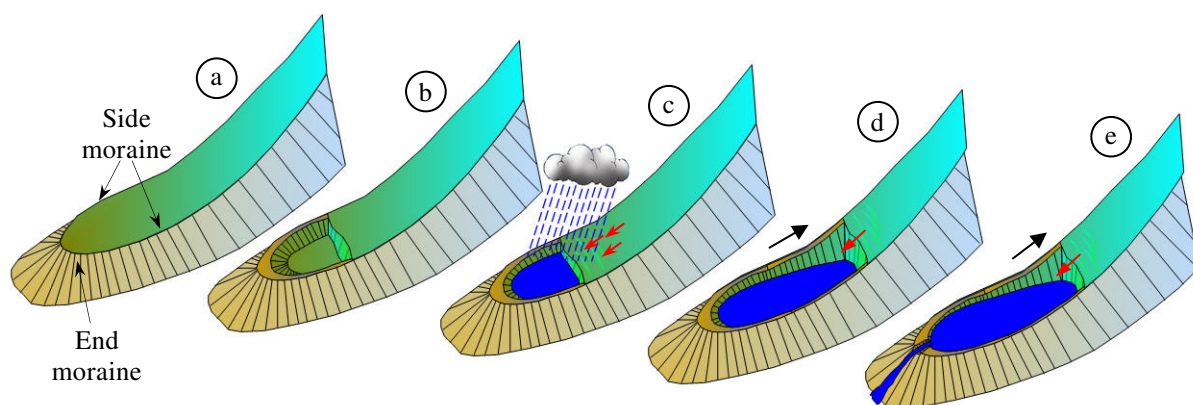

Fig. 1 Formation of moraine-dammed lake.

(a) As a glacier advances down a slope, the ice pushes boulders and soil like a bulldozer, (b) When the glacier subsides, in times of warmer climate, it leaves the rocky debris in a pile called a moraine at the point of the glacier's greatest progress and a gouged-out basin behind the debris line, (c) Rainwater and melt water tend to collect in that basin, dammed by the moraine, (d) Glacier retreat increases size of the lake and (e) Overtopping (Most of the moraine dams are stable for normal overtopping if the inflow discharge in the lake is small).

Table 1 Summary of glacial lakes and potentially dangerous glacial lakes in the Himalaya

S. No.	Country	River basin	Glacial lakes		Reference
			Number	Potential danger	
1	Nepal	Koshi, Gandaki, Karnali and Mahakali	2323	20	Bajracharya et al. (2008)
2	Bhutan	Amo Chu, Wang Chu, Puna Tshang Chu, Manas River, Nyere Ama Chu and Northern basins	2674	24	" "
3	Pakistan	Indus River basin	2420	52	" "
4	India	Tista river, River basin of Himachal and Uttaranchal	549	30	" "
5	China	Ganges Basin	824	77	" "
<b>Total</b>			<b>8790</b>	<b>203</b>	

moraine is known as moraine-dammed lake. The formation process of moraine-dammed lake is shown in Fig. 1. Moraine dams generally fail by overtopping and incision. Potentially dangerous lakes typically require a trigger mechanism to initiate a flood. The triggering event is most frequently an ice avalanche from the toe of the retreating glacier which generates waves that overtop the dam. Failure of dam slopes, melting of ice cores and piping are other failure mechanisms which may cause self destruction of moraine dam. Earthquake is also an external trigger which may cause settlement of the moraine dam and lake outburst. About 80% of GLOFs were initiated by

displacement waves from ice avalanches that collapsed into the lakes from hanging or calving glaciers and rock avalanches (see Fig. 2). NEA (2005) compiled thirty three historical GLOF events that occurred in Nepal and Tibet (China). The causes of failure of thirteen events were unknown. The cause of failure of Dig Tsho was mentioned as rock avalanche however other studies (Vuichard and Zimmermann, 1987; Yamada, 1998) have shown that the failure was due to ice avalanche. Thus, in this study, the cause of failure of Dig Tsho is classified as ice avalanche. The main causes of glacial lake outburst floods are shown in

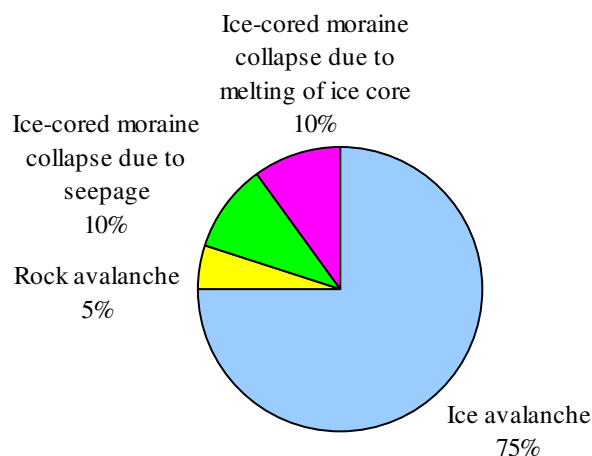

Fig. 2 Causes of glacial lake outburst floods (Based on 20 cases with known failure mechanisms).

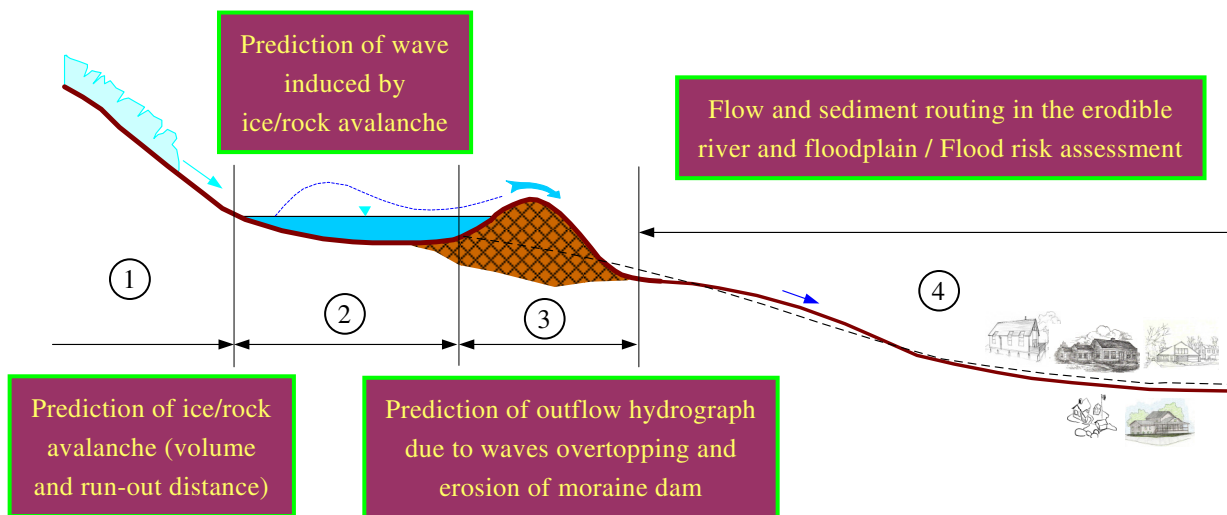

Fig. 3 An integrated model to predict glacial lake outburst flood (GLOF) due to waves overtopping and erosion.

Fig. 2 based on twenty cases of glacial lake outburst floods (with known failure mechanisms) which occurred in Nepal and Tibet (China). Ice avalanching is a common trigger for moraine dam failure because many glaciers have retreated up steep rock slopes and toes of such glaciers are heavily crevassed and wet, and thus prone to failure (Clague and Evans, 2000). The volume of ice avalanche/rock fall may as large as 1/4 to 1/2 of the lake volume (Xu and Feng, 1994). The recent study of one of the potentially dangerous glacial lake in Nepal (Imja glacial lake) by Watanabe et al. (2009) recommended to study overtopping of potential surge waves from terminal moraine that may generate by 43m high ice cliff.

The material comprising most moraine dams is silty, sandy, bouldery till, with minimal clay content. Most of the moraine dams are steep sided (some exceeding 40°). Moraine dams are made of loose, easily erodible materials that are incorporated in the outburst flood, commonly resulting in a debris flow immediately downstream. There are two methods to predict probable peak discharge from potential failure of natural dams. Many empirical relationships are derived to determine peak discharge from data set of historic dam failures for landslide, glacier and moraine dams (Costa, 1988; Walder and O'Connor, 1997). However, these empirical relationships are derived from limited number of cases. The other method employs computer implementation of physically based mathematical models. Several researchers

have developed physically based models (Fread, 1991; Takahashi and Nakagawa, 1994; Awal et al. 2008). However, most of the models are applicable for overtopping and erosion of the dam. Integrated model developed by Awal et al. (2008) is applicable for dam failure due to sliding and overtopping. The mechanism of moraine dam failure in many cases is different from simple overtopping due to snowmelt or precipitation. The high amplitude waves generated by ice/rock avalanche produce rapid erosion of moraine dam. Thus, the released water from breached moraine dam will be highly dependent on size, shape and location of initiation of ice/rock avalanche, height and speed of wave generated. However, an integrated model to predict waves, outflow hydrograph and downstream flooding for such type of failure mode is still lacking. In this context, this study has proposed an integrated model for the i) prediction of waves generated by ice/rock avalanche, ii) prediction of outflow hydrograph due to waves overtopping and erosion of moraine dam and iii) flow and sediment routing in the downstream for flood risk assessment. The general outline of proposed model is shown in Fig. 3. Some of the recent studies on glacial lake outburst floods used BREACH model (Fread, 1991) to predict outflow hydrograph (Bajracharya et al., 2007; Wang et al. 2008). However, this model has limitation to represent batter slopes of dam greater than 11° (Davies et al., 2007) and does not consider waves overtopping due to ice/rock avalanches.

An experiment on moraine dam failure

provides an opportunity to observe failure mechanisms as the failure of a moraine-dammed lake has never been directly witnessed. Most of the experimental studies are focused on prediction of waves generated by landslide/rock avalanche (Fritz et al., 2004; Zweifel et al., 2007). However, very few studies focused on dam breaking by wave-induced erosional incision (Balmforth et al., 2008; Balmforth et al., 2009).

In-depth knowledge of the mechanism of the moraine dam failure by waves overtopping and measured data are still lacking. Extensive laboratory experiments are carried out to study such triggering event and failure mechanism by varying size of ice/rock avalanche, shape of the dam, dam material and freeboard between the crest of the dam and lake water level.

## 2. Experimental Method

The schematic diagram of the flume and other accessories used in the experiments are shown in the Fig. 4. The rectangular flume of length 500cm, width 30cm and depth 50cm was used. The shapes of the moraine dam used in the experiments are trapezoidal with flat crest and triangular. The crest width of trapezoidal dam was 10cm. The height of all dams was 15cm. In general, most of moraine

dams are steep-sided and narrow crest, however some moraine dam has wider flat crest.

Rigid dam of wood and mixed silica sand (Mix: 1-6 and Mix: 1-7) were used to prepare dam in the flume. The mixed silica sand Mix: 1-6 was prepared by mixing silica sand S1, S2, S3, S4, S5 and S6 in equal portion. Similarly, Mix: 1-7 was prepared by mixing silica sand S1, S2, S3, S4, S5, S6 and S7 in equal portion. The mean dia. of sediment Mix: 1-7 and Mix: 1-6 were 1mm and 1.15mm respectively. The grain size distribution of sediment mixtures are shown in Fig. 5. In general, moraine dams comprise loose, poorly sorted, stratified to massive sediment deposited directly from glacier ice. Some moraine dams consist largely of coarse, blocky and bouldery material with a matrix of sand and gravel where as other moraine dams consist of silty and sandy diamicton and sandy gravel (Clague and Evans, 2000). However, details of grain size distribution of most of moraine dams are unknown. Therefore in this study mixed sediments prepared from silica sand were used.

Ice or rock avalanche is a very complicated physical phenomenon. However, for simplicity, in this study block of definite shape was used. A wave was initiated in the lake by falling a rigid block. The volume of Block A was 1/8 of the lake volume (L = 25cm, B = 30cm) and weight was 18.2kg.

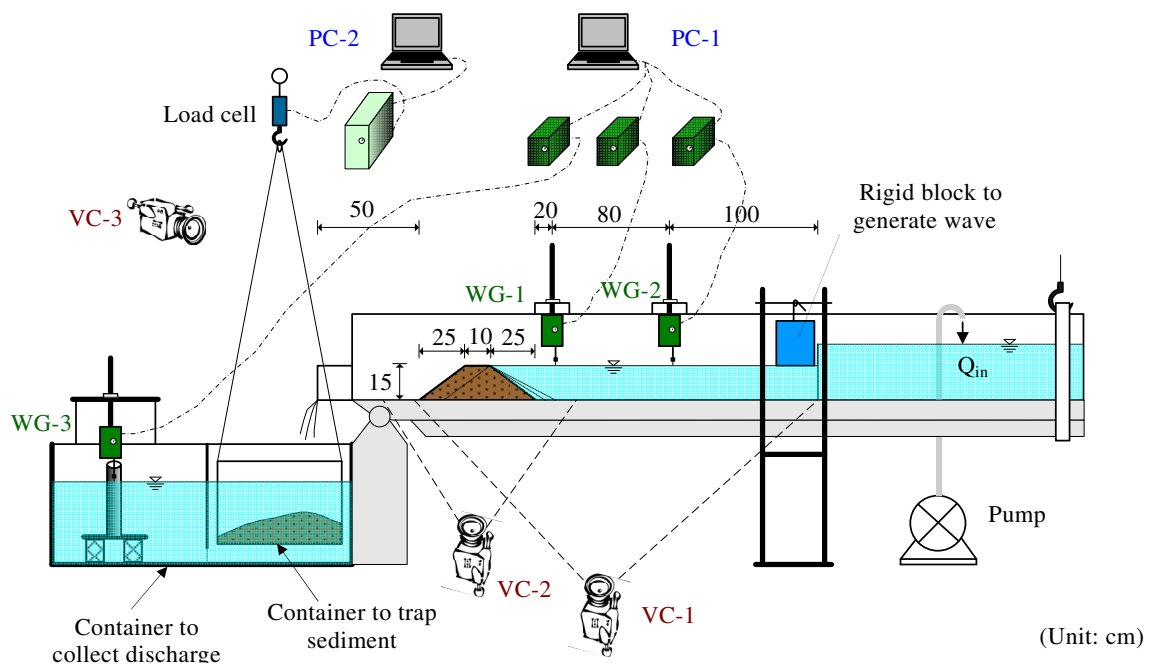

Fig. 4 Experimental setup.

Similarly, the volume of Block B was 1/4 of the lake volume ( $L = 50\text{cm}$ ,  $B = 30\text{cm}$ ) and weight was 33.5kg. Servo-type water gauges, WG-1 and WG-2, were used to measure wave height in the lake at two locations as shown in Fig. 1. WG-1 and WG-2 are located at 130 cm and 210cm respectively from end of the flume.

Load cell and servo-type water gauge (WG-3) were used to measure sediment and total flow in the downstream end of the flume. The arrangement to measure outflow hydrograph both sediment and total discharge at the channel outlet can be achieved by employing container to trap sediment and servo-type water gauge in the downstream tank. The submerged weight of the sediment trapped in the container is measured with the help of load cell at fixed time interval. Three video cameras were used to capture eroded shape of the moraine dam and propagation of waves.

The summary of experiments is shown in Table 2. Basically experiments can be divided into three categories: (i) waves overtopping over rigid dam, (ii) waves overtopping and erosion from full channel width and (iii) waves overtopping and erosion from partial channel width (central and side channel breach).

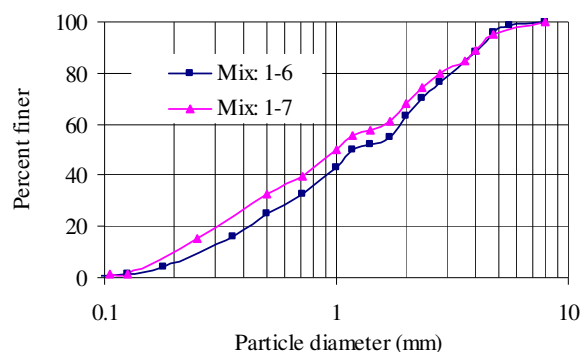

Fig. 5 Grain size distribution of sediment mixes.

Table 2 Summary of experiments.

Cont.						
Expt. No.	Dam shape	Flow condition	Slide mass	Free-board (cm)	Dam material	Remarks
1	Trapezoidal	FCW	Block A	0	Rigid	
2	Trapezoidal	FCW	Block A	2	Rigid	
3	Trapezoidal	FCW	Block B	0	Rigid	
4	Trapezoidal	FCW	Block B	2	Rigid	
5	Triangular	FCW	Block A	0	Rigid	
6	Triangular	FCW	Block A	2	Rigid	
7	Triangular	FCW	Block B	0	Rigid	
8	Triangular	FCW	Block B	2	Rigid	
9	Trapezoidal	FCW	Block A	0.5	Mix: 1-7	Failed by making channel in the left side
10	Trapezoidal	FCW	Block A	2	Mix: 1-7	Stable
11	Trapezoidal	FCW	Block B	0.5	Mix: 1-7	
12	Trapezoidal	FCW	Block B	2	Mix: 1-7	Failed by making channel in the left side
13	Triangular	FCW	Block A	0.65	Mix: 1-7	
14	Triangular	FCW	Block A	2	Mix: 1-7	
15	Triangular	FCW	Block B	0.65	Mix: 1-7	
16	Triangular	FCW	Block B	2	Mix: 1-7	
17	Triangular	FCW	Block B	2	Mix: 1-7	Upstream Slope 3:7 (V:H)
18	Triangular	FCW	Block B	2	Mix: 1-7	Upstream Slope 1:3 (V:H)
19	Trapezoidal	FCW	Block A	2	Mix: 1-6	Stable
20	Trapezoidal	FCW	Block B	2	Mix: 1-6	
21	Triangular	FCW	Block A	2	Mix: 1-6	
22	Triangular	FCW	Block B	2	Mix: 1-6	
23	Trapezoidal	PCW-C	Block A	2	Mix: 1-7	Stable
24	Trapezoidal	PCW-C	Block B	2	Mix: 1-7	
25	Triangular	PCW-C	Block A	2	Mix: 1-7	
26	Triangular	PCW-C	Block B	2	Mix: 1-7	
27	Trapezoidal	PCW-C	Block A	2	Mix: 1-6	
28	Trapezoidal	PCW-C	Block B	2	Mix: 1-6	
29	Triangular	PCW-C	Block A	2	Mix: 1-6	
30	Triangular	PCW-C	Block B	2	Mix: 1-6	
31	Triangular	PCW-S	Block A	2	Mix: 1-7	
32	Triangular	PCW-S	Block A	2	Mix: 1-6	

Note: FCW = Full channel width, PCW-C = Partial channel width (Central channel breach), PCW-S = Partial channel width (Side channel breach), FB = Freeboard

### 3. Results and Discussions

A wave was initiated in the reservoir by dropping different size blocks. The reservoir was filled with water up to a depth according to desired freeboard. The water was then left to seep through the dam. The block was dropped from height close to water surface when seepage flow reached downstream toe. Propagation of waves generated by falling Block A and Block B (FB = 2cm) are shown in Fig. 6 and Fig 7 respectively. The waves measured at two locations in the upstream reservoir by using servo-type water level gauge and video captured from side of the flume are shown in Fig. 8 and Fig. 9. The amplitude of waves generated by Block B was higher than Block A. Wave amplitude

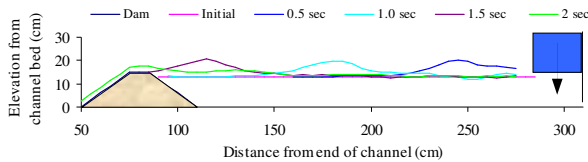

Fig. 6 Propagation of waves generated by falling block (Block A).

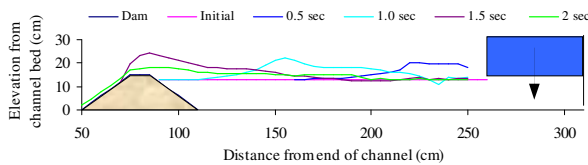

Fig. 7 Propagation of waves generated by falling block (Block B).

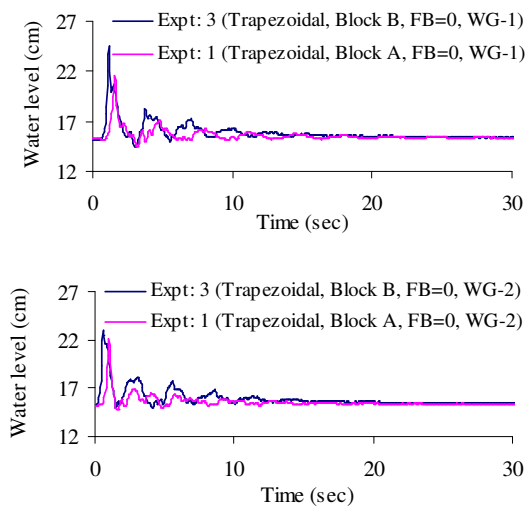

Fig. 8 Waves measured at different locations in the upstream reservoir for FB = 0.

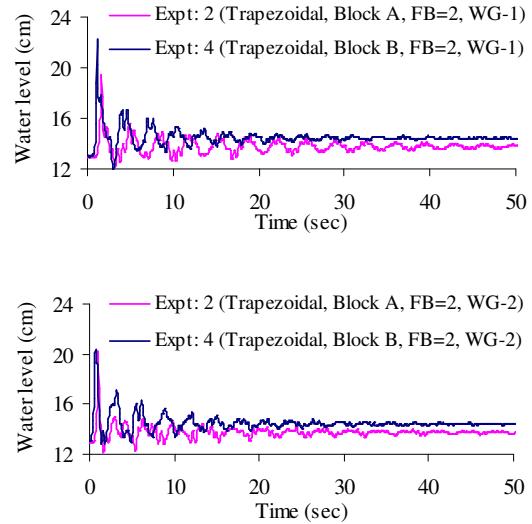

Fig. 9 Waves measured at different locations in the upstream reservoir for FB = 2cm.

decreased quickly when the water level was almost full (FB = 0) in the reservoir (Fig. 8), however it took long time to stabilize the wave amplitude in the reservoir with freeboard of 2cm (Fig. 9).

In all experiments wave was initiated by employing same method and measured using servo-type water level gauge.

Overtopping waves may carry enough water over stable moraine dam. Rigid dams of wood are used to make stable dam. Most of the glacial lakes are narrow in the width. If the volume of ice/rock avalanche is very big, overtopping may occur from whole width of end moraine. However, most of the wave overtopping occurs from partial width of end moraine from existing channel. Therefore, in this study, we have considered following three cases:

#### 3.1 Outflow hydrograph due to waves overtopping over rigid dam

Fig. 10 shows the outflow hydrographs due to waves overtopping over rigid dams. The resulting peak discharge in the trapezoidal and triangular rigid dams were similar for different initial water depths in the lake and blocks used to generate waves. The total volume of water drained from the lakes with freeboard of 0cm was almost equal in both shaped dams. However, in the case of freeboard of 2cm the total volume of water drained in the triangular dam was 8 to 15% higher than trapezoidal dam.



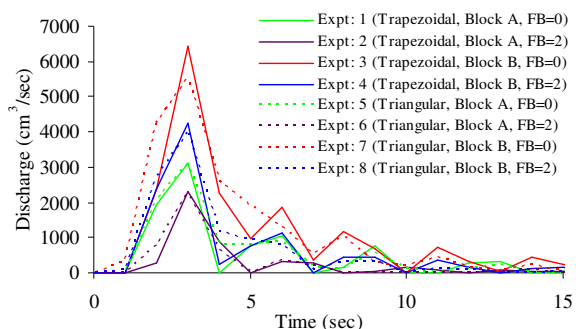

Fig. 10 Outflow hydrographs due to waves overtopping over rigid dam.

### 3.2 Outflow hydrograph due to waves overtopping and erosion of moraine dam (Full channel width)

Numbers of experiments were done to study the effects of shape of the dam, freeboard, dam material and upstream slope of the dam on outflow hydrograph.

#### (1) Effect of shape of the dam on outflow hydrographs

Trapezoidal dam with freeboard of 2cm was stable for waves generated by Block A. Fig. 11 shows the outflow hydrographs due to waves overtopping and erosion of the moraine dam for flow from full channel width. The waves generated by dropping a block in the lake overtopped moraine dam and produced initial peak discharge in the downstream. Flow was reduced during runback of waves. The reflected waves repeatedly overtopped the dam and produced multiple peaks. Breaching of moraine dam and rapid lowering of lake water level occurred after erosion of crest and overtopping of

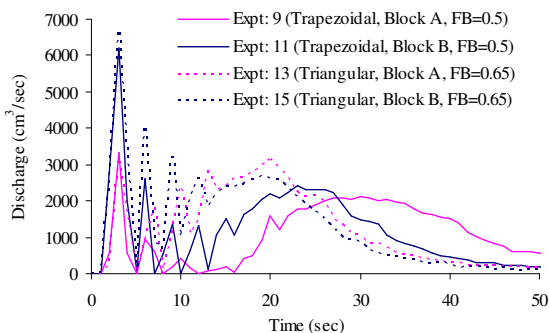

Fig. 11 Outflow hydrographs due to waves overtopping and erosion of moraine dam (for dam with different shapes).

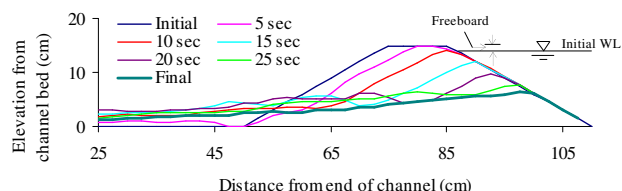

Fig. 12 Dam surface erosion (Expt: 11).

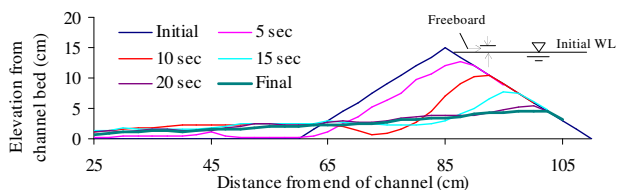

Fig. 13 Dam surface erosion (Expt: 15).

reflection waves many times. The initial discharge produced by both rigid blocks, Block A and B in both shape of the dams were similar. However, peak discharge produced after erosion of the dam in the triangular dam was higher and occurred earlier compare with trapezoidal dam. The small difference in freeboard (1.5mm) between two shapes of the dam caused only minimal influence on outflow hydrographs. Erosion of the dam was started from outer face in both shapes as shown in Fig. 12 and Fig. 13. However, it took some time to erode flat crest of the trapezoidal dam, so peak discharge occurred earlier in the case of triangular dam. Thus narrow dams are more vulnerable to overtopping and erosion.

#### (2) Effect of freeboard on outflow hydrographs

Volume of water drained from the lake and amplitude of wave generated in the lake depends on depth of water in the reservoir. When freeboard is low, the overtopping water depth in the dam crest due to waves is higher and erode dam body very

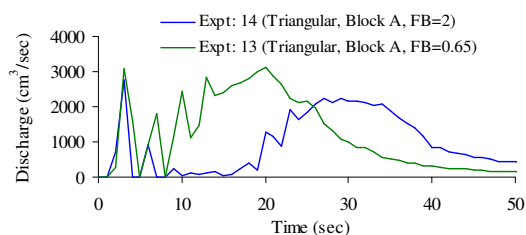

Fig. 14 Outflow hydrographs for dam with different freeboards.

fast, so peak discharge occur earlier and magnitude of peak discharge is also higher as shown in Fig. 14. Therefore the lake with little freeboard is more vulnerable to overtopping and erosion by displacement waves from ice/rock avalanches.

### (3) Effect of dam material on outflow hydrographs

Sediment mixes 1-6 and 1-7 were used to prepare dam. The mean diameter of Mix: 1-6 was bigger than Mix: 1-7. However, shear strength due to suction plays vital role in erosion of unsaturated fine sediments. This is the main reason for rapid erosion of the dam prepared from Mix: 1-6 compared with dam prepared from Mix: 1-7 even if the mean diameter of sediment is bigger (see Fig. 15).

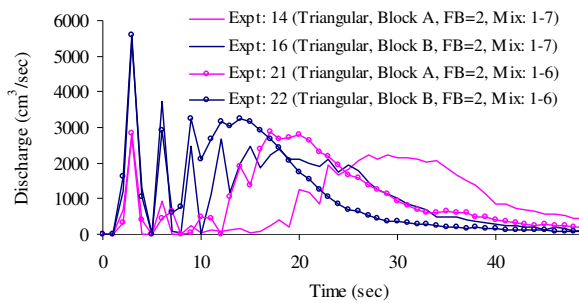

Fig. 15 Outflow hydrographs for dam of different sediment mixes.

### (4) Effect of upstream slope of the dam on outflow hydrographs

The longitudinal profiles (see Fig. 16) of some of the potentially dangerous glacial lakes in Nepal

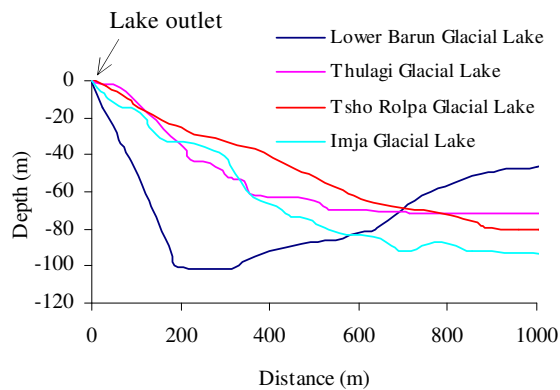

Fig. 16 Longitudinal profiles of potentially dangerous glacial lakes in Nepal.

(Tsho Rolpa, Imja, Thulagi and Lower Barun) derived from Mool et al. (2001) shows that the upstream slope of end moraines are flatter (9 to 17 degree). The result of experiments 16, 17 and 18 showed the effect of slope of inner face of the moraine dam in outflow hydrographs. Multiple peak discharges due to waves overtopping and erosion of the dam was higher in the dam with steeper slope of inner face (see Fig. 17). The total volume of water drained from the lake was also higher in the dam with steeper slope of inner face.

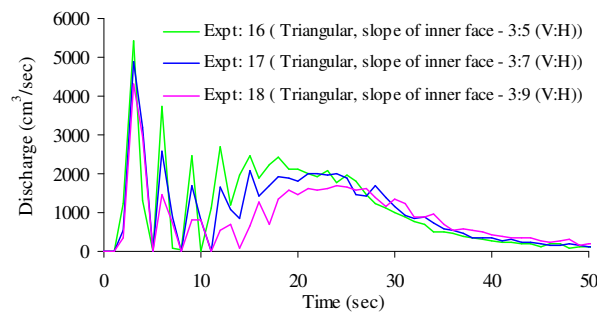
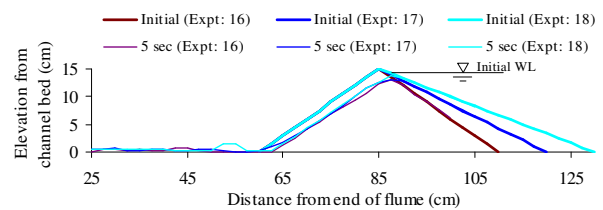
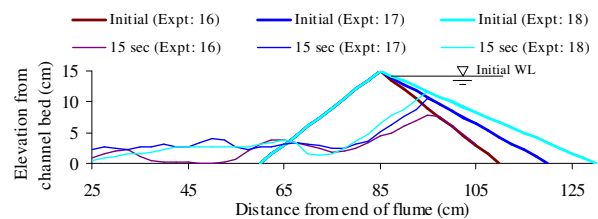

Fig. 17 Outflow hydrographs for dam with different upstream slopes.



(a) At 5 sec



(b) At 15 sec

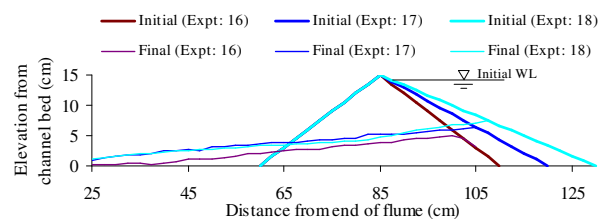

(c) Final shape

Fig. 18 Dam surface erosion.



The temporal changes of dam shape for different upstream slopes of the dam are shown in Fig. 18. The eroded slope of outer face of the dam continued to migrate backwards and the height of the eroded dam decreased rapidly in the dam with steeper slope of inner face, so the multiple peak discharges and total volume of water drained from the lake were higher in the dam with steeper slope of inner face.

The multiple peaks in all cases (1), (2), (3) and (4) are due to overtopping and erosion of the dam from reflected waves. The magnitude of multiple peaks will be also affected by size (length and breadth) of the reservoir. However, in this study, the size of the reservoir used in all cases is same.

### 3.3 Outflow hydrograph due to waves overtopping and erosion of the moraine dam (Partial channel width)

Notch of the width 10cm and depth 0.8cm was incised at the center (Experiments with flow condition: PCW-C) and side (Experiments with flow condition: PCW-S) of the dam crest and downstream face of the dam. In the beginning, overtopping occurred from full channel width. The reflected waves generated in the later stage caused channel breaching. The trapezoidal dam of experiment 23 was stable for waves generated by block A even if overtopping occurred in the beginning. The breaching of channel in the triangular dam was faster compare with trapezoidal dam as shown in Fig. 19. Similarly, breaching of the dam prepared from Mix: 1-6 was faster compare with Mix: 1-7 for both channel breach at center and side of the dam (see Fig. 19 and Fig. 20). In the

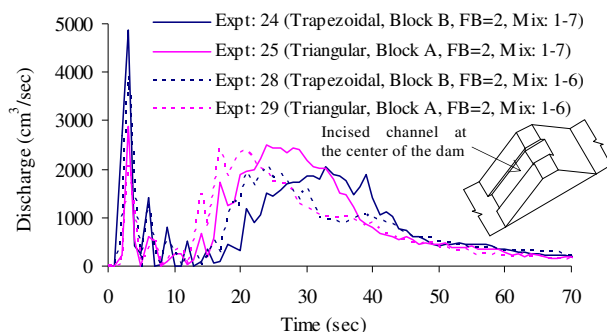

Fig. 19 Outflow hydrographs due to waves overtopping and erosion of moraine dam (Partial channel width - center).

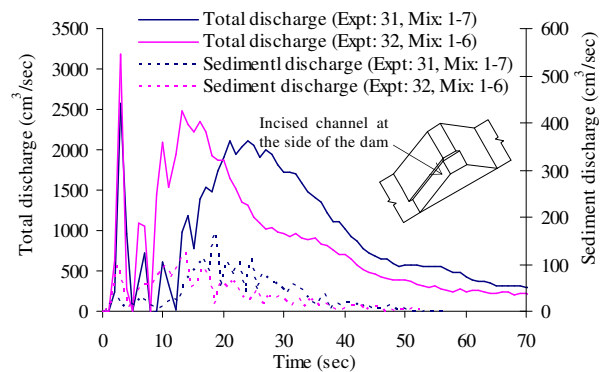
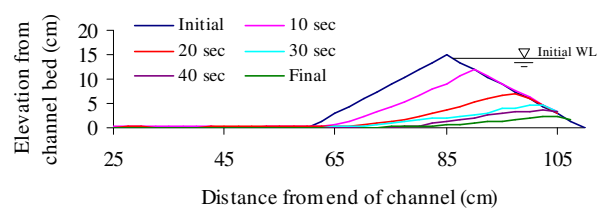
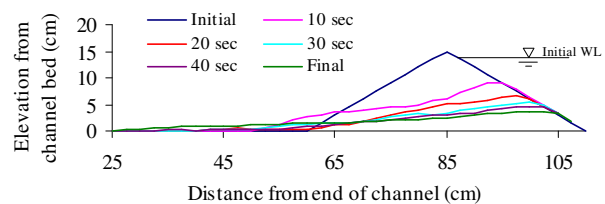

Fig. 20 Outflow hydrographs due to waves overtopping and erosion of moraine dam (Partial channel width - side).



(a) Side channel breach (Expt: 31, Mix: 1-7).



(b) Side channel breach (Expt: 32, Mix: 1-6).

Fig. 21 Longitudinal profile of breached channel at the flume edge.

case of side channel breach, longitudinal profile of breached channel is derived from snaps captured by video camera positioned in the side of the flume. The temporal change of longitudinal profile of breached channel is shown in Fig. 21, which shows rapid incision of dam prepared by using sediment Mix: 1-6. The section of breached channel at crest was almost vertical (overhanging in some cases) in the dam prepared by using sediment Mix: 1-7. Armouring effect was also negligible compare with dam prepared by using sediment Mix: 1-6. This is the main reason for higher depth of breached channel in the dam prepared by using Mix: 1-7. The shape of breached channel (Front view and top view) for dam prepared by using sediment Mix: 1-7 and Mix 1-6 are shown in Fig. 22.

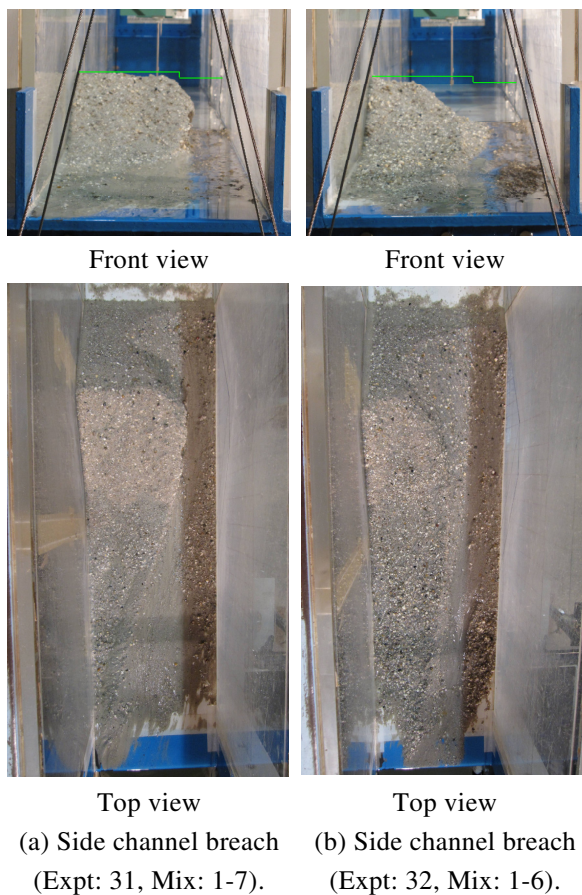

Fig. 22 Shape of breached channel.

#### 4. Conclusions

About 80% of GLOFs were initiated by displacement waves from ice avalanches that collapsed into the lakes from hanging or calving glaciers and rock avalanches. However, an integrated model to predict waves and outflow hydrograph for such type of failure mode is still lacking. Therefore, an integrate model is essential for the i) prediction of waves generated by ice/rock avalanche, ii) prediction of outflow hydrograph due to waves overtopping and erosion of moraine dam and iii) flow and sediment routing in the erodible river and floodplain in the downstream for flood risk assessment.

Extensive laboratory experiments were performed to study moraine dam failure due to waves overtopping and erosion. The outflow hydrographs produced by waves overtopping and erosion consist multiple peaks. For the same falling block and lake water level, the initial peaks produced by overtopping were similar for both triangular and trapezoidal dams. However,

magnitude and timing of subsequent peaks were different according to dam shapes and dam materials. The shape of outflow hydrograph also depends on upstream slope of the dam. Multiple peak discharges due to waves overtopping and erosion of the dam was higher in the dam with steeper slope of inner face. Trapezoidal dam with sufficient freeboard was stable for waves generated by ice/rock avalanche of 1/8 of lake volume. The outflow hydrograph depends on many factors such as dam shape, freeboard, dam material, size of ice/rock avalanche, size of the lake etc, so further study should be directed towards development of numerical model to predict outflow hydrograph resulting from waves overtopping and erosion of moraine dam.

#### Acknowledgements

This work was supported by the Japan Society for the Promotion of Science Postdoctoral Fellowship Program (grant-in-aid P 09080). The authors wish to thank Atsushi Shimizu for his help to prepare abstract in Japanese.

#### References

- Awal, R., Nakagawa, H., Kawaike, K., Baba, Y. and Zhang, H. (2008): An integrated approach to predict outflow hydrograph due to landslide dam failure by overtopping and sliding, *Annual Journal of Hydraulic Engineering, JSCE*, Vol. 52, pp. 151-156.
- Bajracharya, B., Shrestha, A.B. and Rajbhandari, L. (2007): Glacial lake outburst floods in the Sagarmatha region – Hazard assessment using GIS and hydrodynamic modeling, *Mountain Research and Development*, Vol. 27, No. 4, pp. 336-344.
- Bajracharya, S.R., Mool, P.K. and Shrestha, B.R. (2008): Global climate change and melting of Himalayan glaciers, in Ranade, P. S., ed., *Melting glaciers and rising sea levels: Impacts and implications*, The Icfai's University Press, pp. 28-46.
- Balmforth, N. J., von Hardenberg, J., Provenzale, A. and Zammatt, R. (2008): Dam breaking by wave-induced erosional incision, *Journal of Geophysical Research*, Vol. 113, F01020,

- doi:10.1029/2007JF000756.
- Balmforth, N.J., von Hardenberg, J. and Zammett, R.J. (2009): Dam-breaking seiches, *J. Fluid Mech.*, Vol. 628, pp. 1-21.
- Clague, J.J. and Evans, S. G. (2000): A review of catastrophic drainage of moraine-dammed lakes in British Columbia, *Quaternary Science Reviews*, Vol. 19, pp. 1763-1783.
- Costa, J.E. and Schuster, R.L. (1988): The formation and failure of natural dams, *Geol. Soc. America Bull.* 100, pp. 1054-1068.
- Costa, J.E. (1988): Floods from dam failures, *Flood Geomorphology*, V. R. Baker, R. C. Kochel, and P. C. Patton eds., John Wiley, New York, pp. 439-463.
- Davies, T.R., Manville, V., Kunz, M. and Donadini, L. (2007): Modeling landslide dambreak flood magnitudes: case study, *Journal of Hydraulic Engineering*, Vol. 133(7), pp. 713-720.
- Fread, D.L. (1991): BREACH: an erosion model for earthen dam failures, U.S. National Weather Service, Office of Hydrology, Silver Spring, Maryland.
- Fritz, H. M., Hager, W. H. and Minor, H.-E. (2004): Near field characteristics of landslide generated impulse waves, *J. Waterway, Port, Coastal and Ocean Eng.*, Vol. 130(6), pp. 287-302.
- Haeberli, W. (1983): Frequency and characteristics of glacier floods in the Swiss Alps, *Annals of Glaciology*, Vol. 4, pp. 85-90.
- Lliboutry, L., Morales Arno, B., Pautre, A. and Schneider, B. (1977): Glaciological problems set by the control of dangerous lakes in Cordillera Blanca, Peru. I. Historical failures of morainic dams, their causes and prevention, *Journal of Glaciology*, Vol. 18, pp. 239-254.
- Mool, P.K., Bajracharya, S.R. and Joshi, S.P. (2001): Inventory of glaciers, glacial lakes and glacial lake outburst flood monitoring and early warning systems in the Hindu Kush-Himalayan region – Nepal, ICIMOD.
- Nepal Electricity Authority (2005): Upper Tamakoshi Hydroelectric Project Feasibility Study, Final Report, Volume 3, Appendix D, Glacial Lake Outburst Flood Risk Assessment Study.
- Richardson, S.D. and Reynolds, J.M. (2000): An overview of glacial hazards in the Himalayas, *Quaternary International*, Vol. 65/66, pp. 31-47.
- Takahashi T. and Nakagawa, H. (1994): Flood/debris flow hydrograph due to collapse of a natural dam by overtopping, *Journal of Hydroscience and Hydraulic Engineering*, JSCE, Vol. 12, No. 2, pp. 41-49.
- Vuichard, D. and Zimmerman, M. (1987): The catastrophic drainage of a moraine-dammed lake, Khumbu Himal, Nepal: cause and consequences, *Mountain Research and Development*, Vol. 7, pp. 91-110.
- Walder, J.S. and O'Connor, J.E. (1977): Methods for predicting peak discharge of floods caused by failure of natural and constructed earthen dams, *Water Resources Research*, Vol. 33, No. 10, pp. 2337-2348.
- Wang X., Lui S., Guo W. and Xu J. (2008): Assessment and simulation of glacier lake outburst floods for Longbasaba and Pida lakes, China, *Mountain Research and Development*, Vol. 28, No. 3/4, pp. 310-317.
- Watanabe, T., Lamsal, D. and Ives, J.D. (2009): Evaluating the growth characteristics of a glacial lake and its degree of danger: Imja Glacier, Khumbu Himal, Nepal, *Norsk Geografisk Tidsskrift (Norwegian Journal of Geography)*, Vol. 63, pp. 255-267.
- Xu D. and Feng Q. (1994): Dangerous glacier lakes and their outburst features in the Tibetan Himalayas, *Bulletin of Glacier Research*, Vol. 12, pp. 1-8.
- Yamada, T. (1998): Glacier lake and its outburst flood in the Nepal Himalaya, Japanese Society of Snow and Ice, Data Centre for Glacier Research, Monograph No.1, 96 pp.
- Zweifel, A., Zuccala, D. and Gatti, D. (2007): Comparison between computed and experimentally generated impulse waves, *Journal of Hydraulic Engineering*, Vol. 133(2), pp. 208-216.

## 越流波とモレーンダム侵食による氷河湖決壊洪水の実験的研究

Ripendra AWAL・中川一・藤田正治・川池健司・馬場康之・張浩

### 要 旨

氷河湖決壊洪水はその下流域において大規模な洪水を引き起こす恐れがあり、その80%は氷河や氷河湖（モレーンダム湖）内に浸水する氷河先端部の崩壊に起因する波によって生じる。統合型数値モデルの開発に向けて、(1)氷河の崩壊によって生じる波の予測、(2)越流およびモレーンダム侵食による流出ハイドログラフの予測、(3)洪水危険度評価のための下流域の洪水と堆砂過程の予測は不可欠であり、本研究では越流波と侵食によるモレーンダムの決壊に着目し室内実験を行った。室内実験では、氷河の崩壊規模、堤体形状と材料、ダム湖の水位を変化させ、越流波と侵食による流出ハイドログラフが複数のピークを有することを確認した。さらに、崩壊規模とモレーンダム湖の水位が同様の条件のもと三角形形状と台形形状の堤体ではともに流出ハイドログラフの初期ピークは同様の傾向を示したが、その後のピークの規模と時刻は堤体形状と材料に応じて異なることを確認した。

**キーワード：** 氷河湖決壊洪水, 越流波, 侵食, 流出ハイドログラフ, 室内実験