

Figures 1–16

Shigeru Takata, Masanari Hattori, and Tatsuya Hasebe

See Note_V2.pdf for the explanation of figures below.

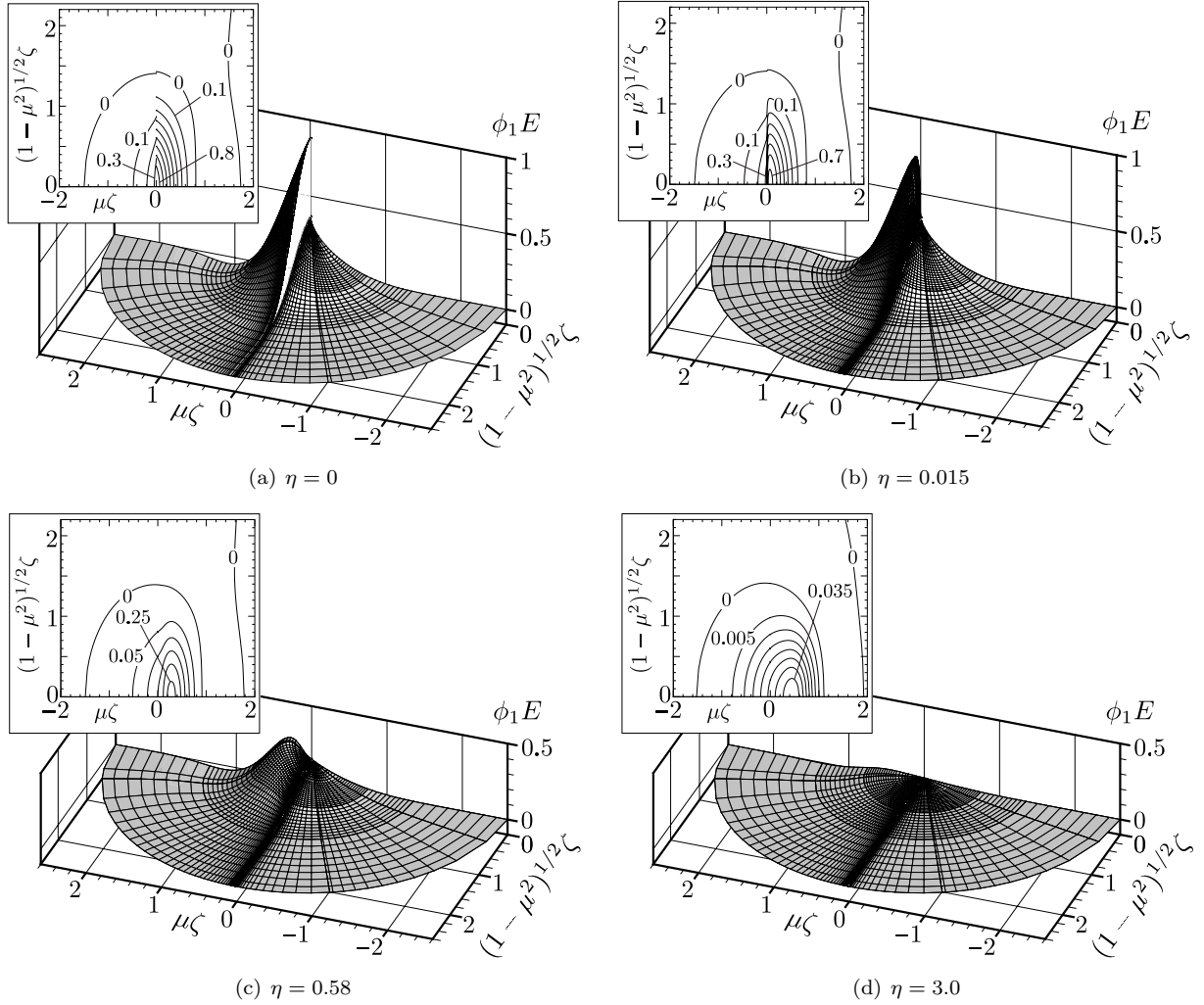

Figure 1: $\phi_1 E$ for the HS gas under the diffuse reflection condition and its contour plots at four spatial points. (a) $\eta = 0$, (b) $\eta = 0.015$, (c) $\eta = 0.58$, and (d) $\eta = 3.0$. In the contour plots, the curves are drawn with the intervals 0.1 in (a) and (b), 0.05 in (c), and 0.005 in (d). The white vertical surface at $\mu\zeta = 0$ in (a) shows the discontinuity.

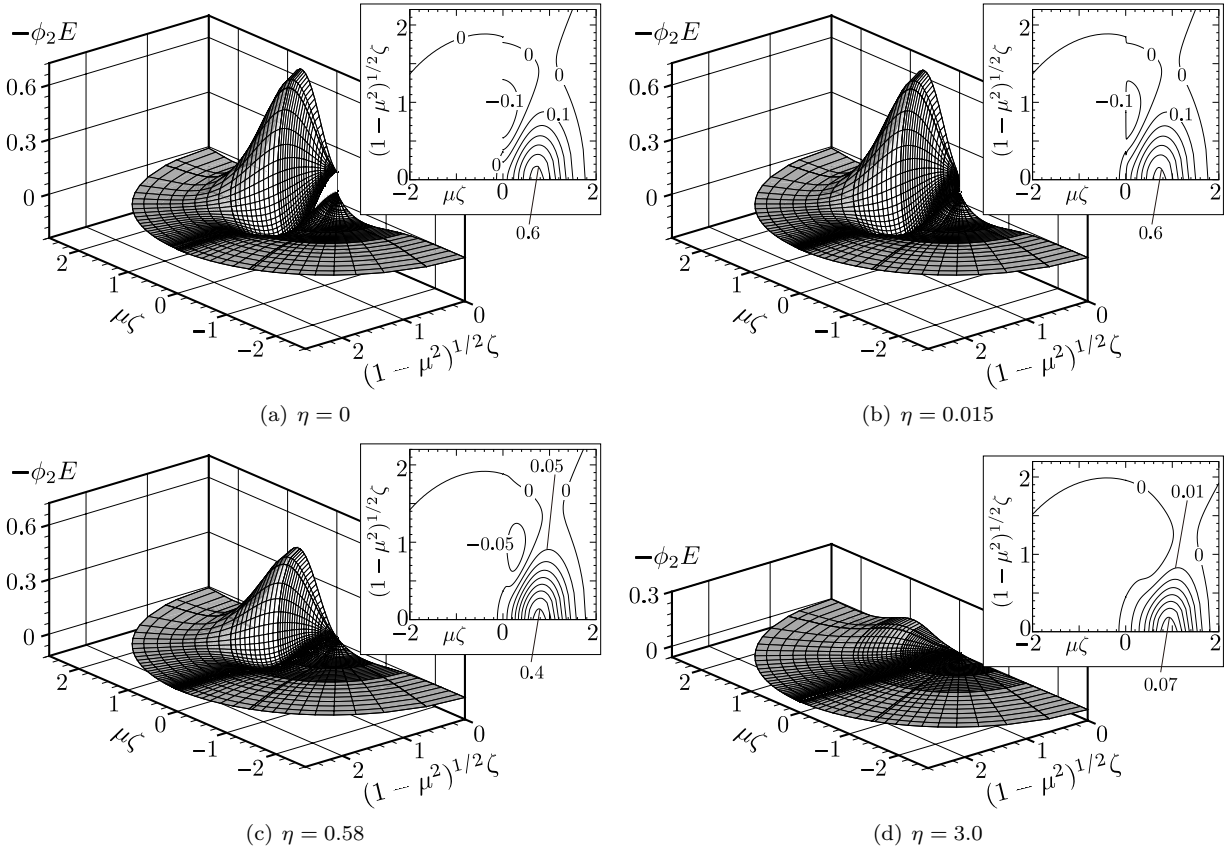

Figure 2: $\phi_2 E$ for the HS gas under the diffuse reflection condition and its contour plots at four spatial points. (a) $\eta = 0$, (b) $\eta = 0.015$, (c) $\eta = 0.58$, and (d) $\eta = 3.0$. In the contour plots, the curves are drawn with the intervals 0.1 in (a) and (b), 0.05 in (c), and 0.01 in (d). The white vertical surface at $\mu\zeta = 0$ in (a) shows the discontinuity.

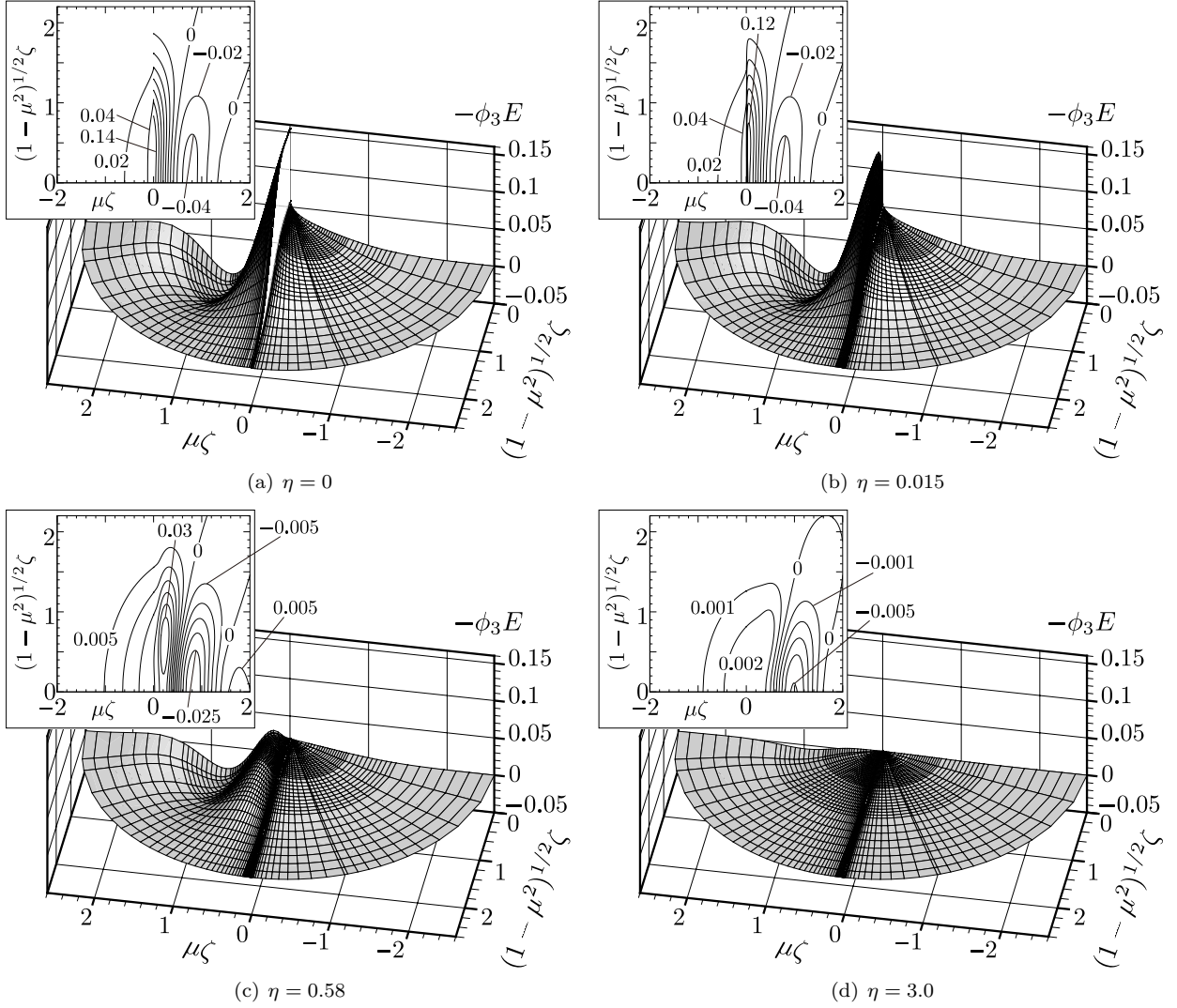

Figure 3: $\phi_3 E$ for the HS gas under the diffuse reflection condition and its contour plots at four spatial points. (a) $\eta = 0$, (b) $\eta = 0.015$, (c) $\eta = 0.58$, and (d) $\eta = 3.0$. In the contour plots, the curves are drawn with the intervals 0.02 in (a) and (b), 0.005 in (c), and 0.001 in (d). The white vertical surface at $\mu\zeta = 0$ in (a) shows the discontinuity.

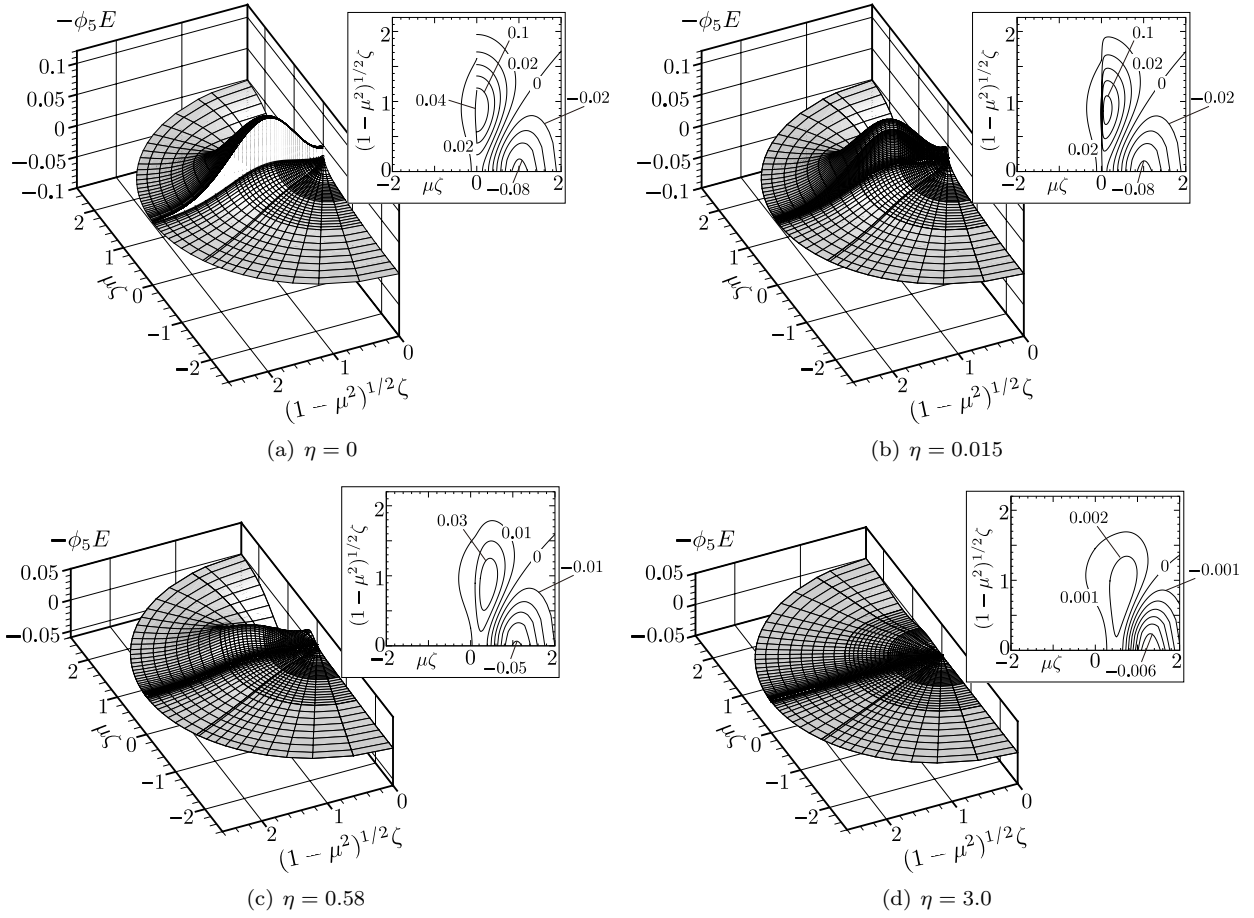

Figure 4: $\phi_5 E$ for the HS gas under the diffuse reflection condition and its contour plots at four spatial points. (a) $\eta = 0$, (b) $\eta = 0.015$, (c) $\eta = 0.58$, and (d) $\eta = 3.0$. In the contour plots, the curves are drawn with the intervals 0.02 in (a) and (b), 0.01 in (c), and 0.001 in (d). The white vertical surface at $\mu\zeta = 0$ in (a) shows the discontinuity.

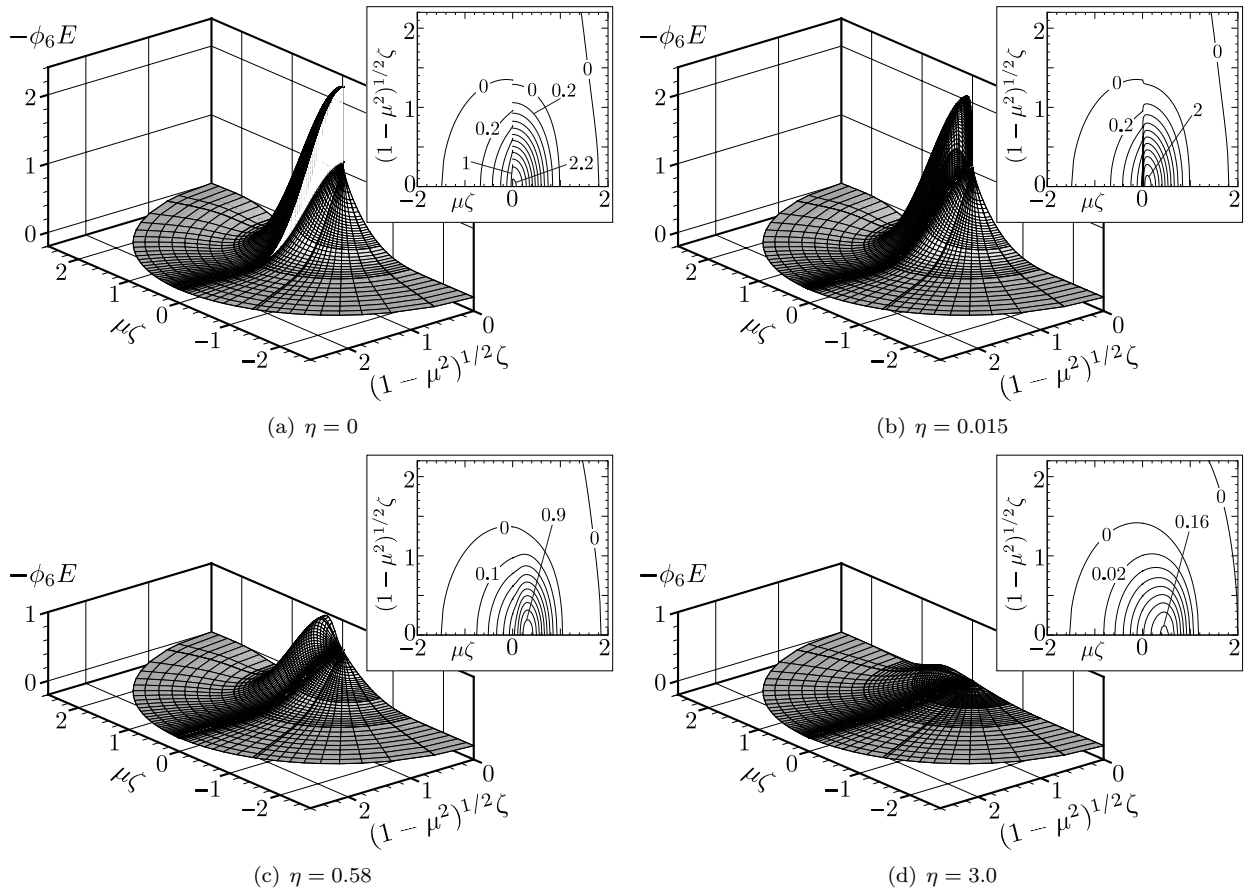

Figure 5: $\phi_6 E$ for the HS gas under the diffuse reflection condition and its contour plots at four spatial points. (a) $\eta = 0$, (b) $\eta = 0.015$, (c) $\eta = 0.58$, and (d) $\eta = 3.0$. In the contour plots, the curves are drawn with the intervals 0.2 in (a) and (b), 0.1 in (c), and 0.02 in (d). The white vertical surface at $\mu\zeta = 0$ in (a) shows the discontinuity.

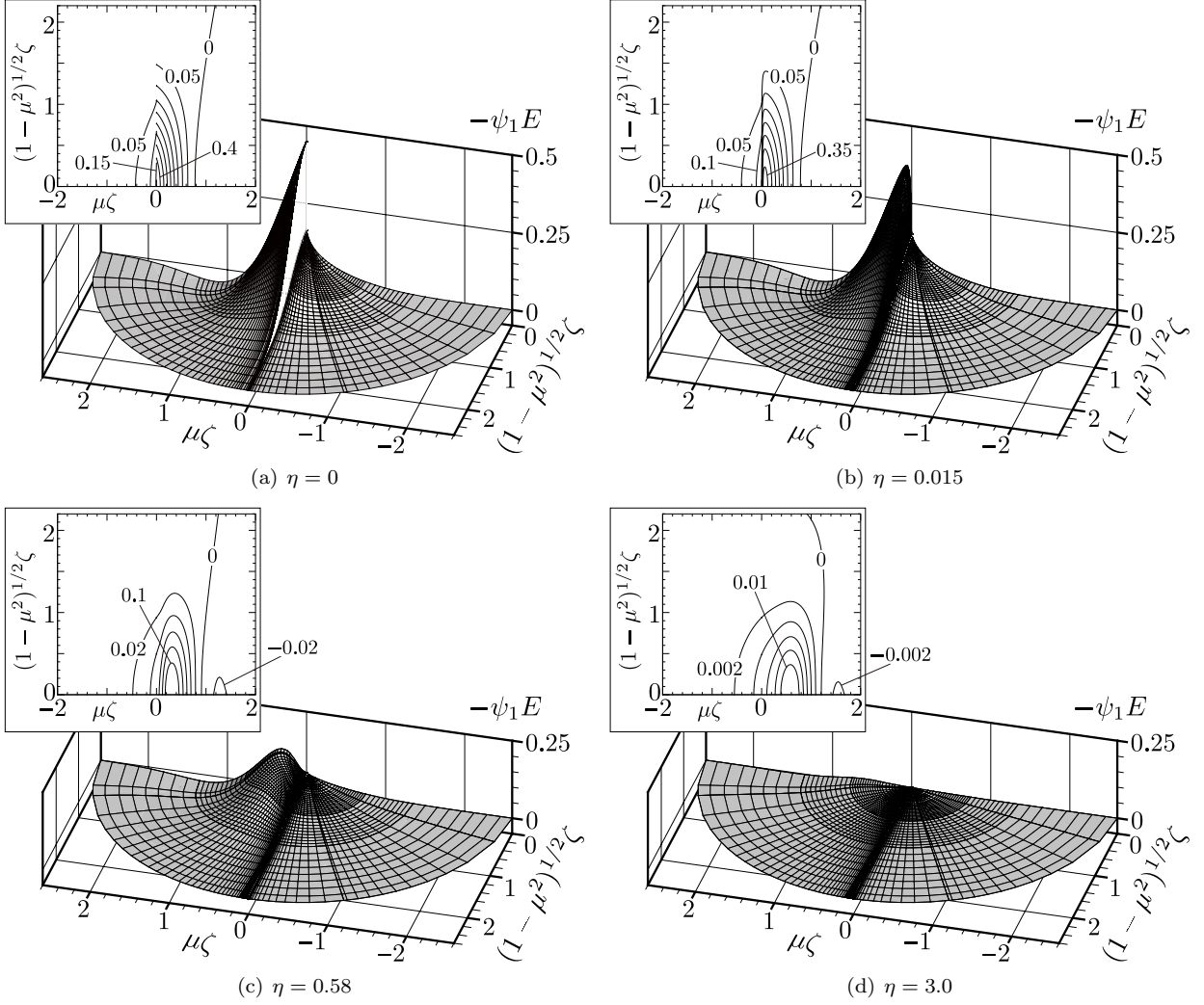

Figure 6: $\psi_1 E$ for the HS gas under the diffuse reflection condition and its contour plots at four spatial points. (a) $\eta = 0$, (b) $\eta = 0.015$, (c) $\eta = 0.58$, and (d) $\eta = 3.0$. In the contour plots, the curves are drawn with the intervals 0.05 in (a) and (b), 0.02 in (c), and 0.002 in (d). The white vertical surface at $\mu\zeta = 0$ in (a) shows the discontinuity.

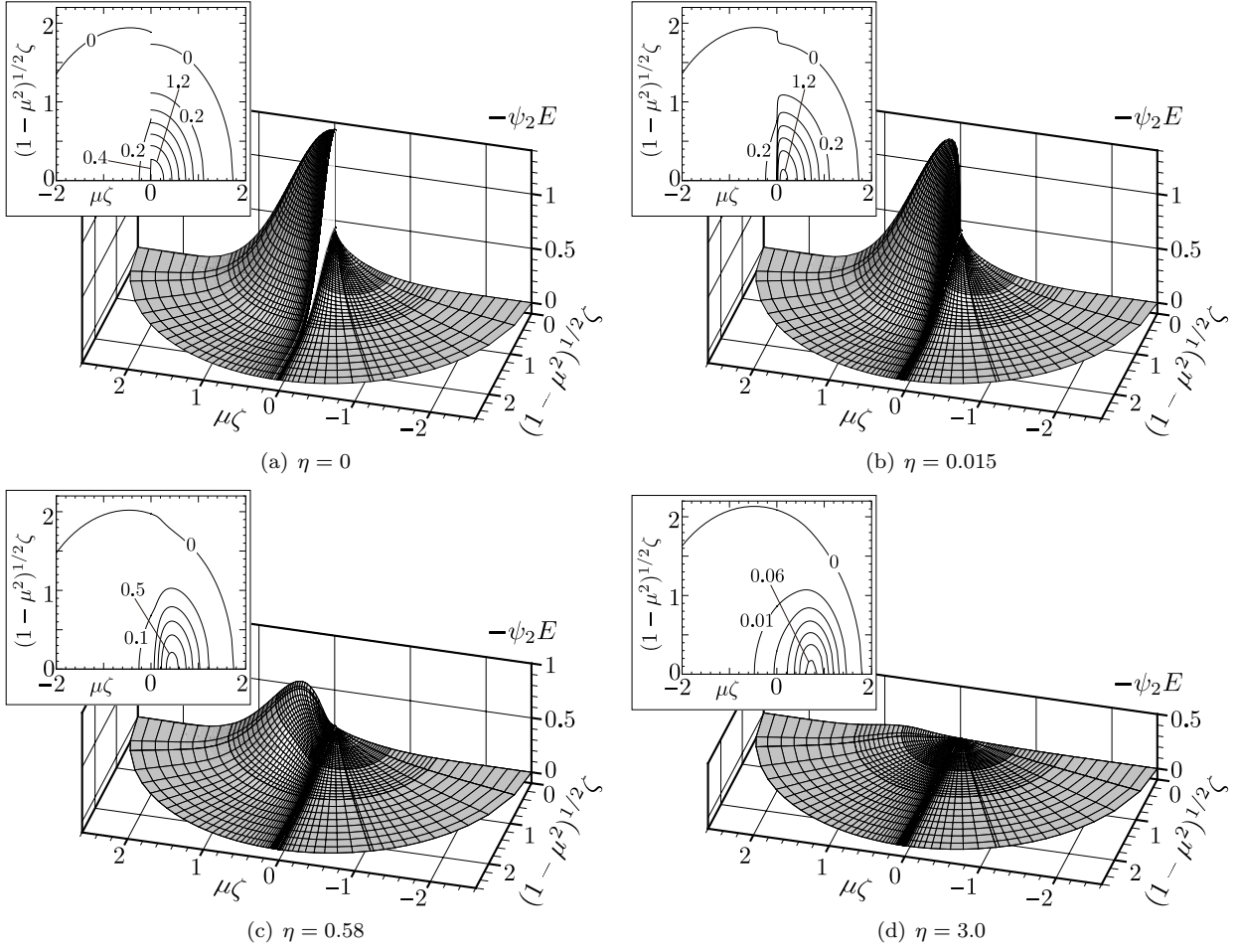

Figure 7: $\psi_2 E$ for the HS gas under the diffuse reflection condition and its contour plots at four spatial points. (a) $\eta = 0$, (b) $\eta = 0.015$, (c) $\eta = 0.58$, and (d) $\eta = 3.0$. In the contour plots, the curves are drawn with the intervals 0.2 in (a) and (b), 0.1 in (c), and 0.01 in (d). The white vertical surface at $\mu\zeta = 0$ in (a) shows the discontinuity.

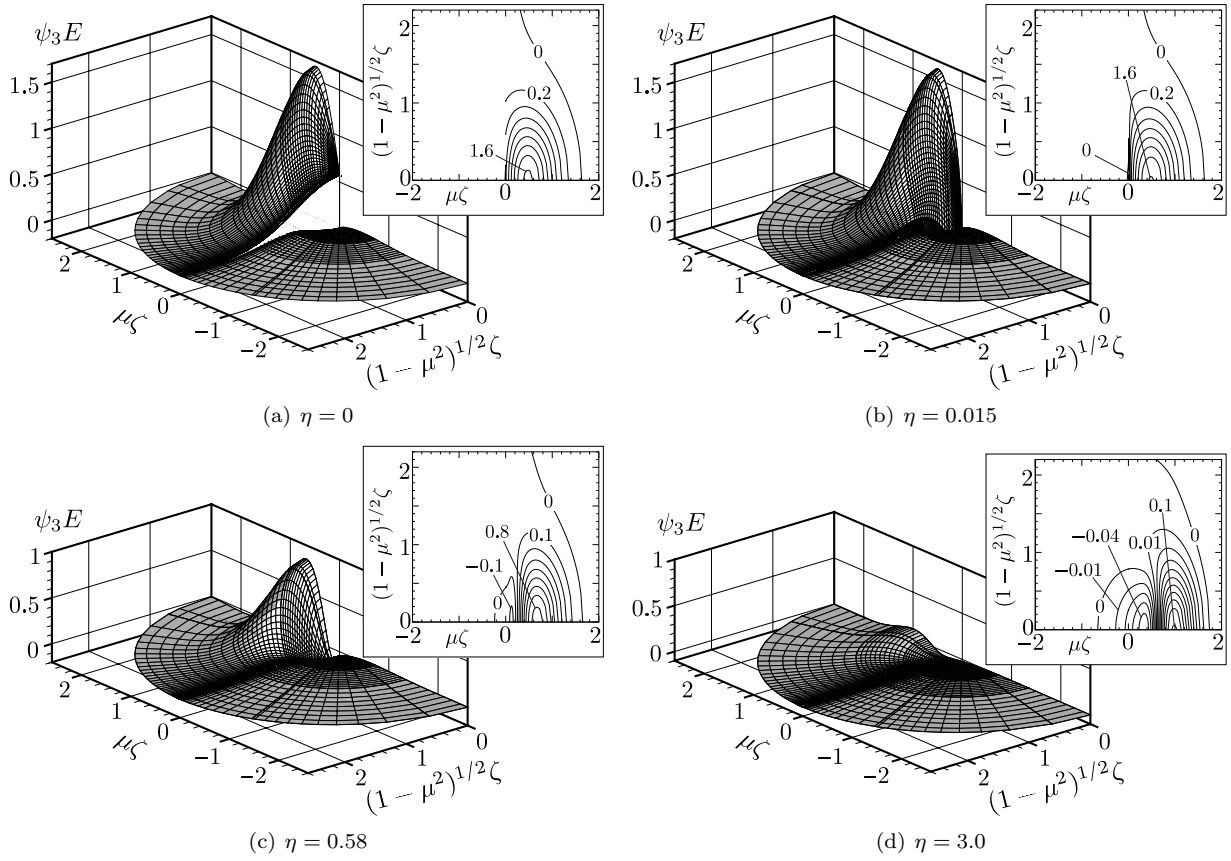

Figure 8: $\psi_3 E$ for the HS gas under the diffuse reflection condition and its contour plots at four spatial points. (a) $\eta = 0$, (b) $\eta = 0.015$, (c) $\eta = 0.58$, and (d) $\eta = 3.0$. In the contour plots, the curves are drawn with the intervals 0.2 in (a) and (b), 0.1 in (c), and 0.01 in (d). The white vertical surface at $\mu\zeta = 0$ in (a) shows the discontinuity.

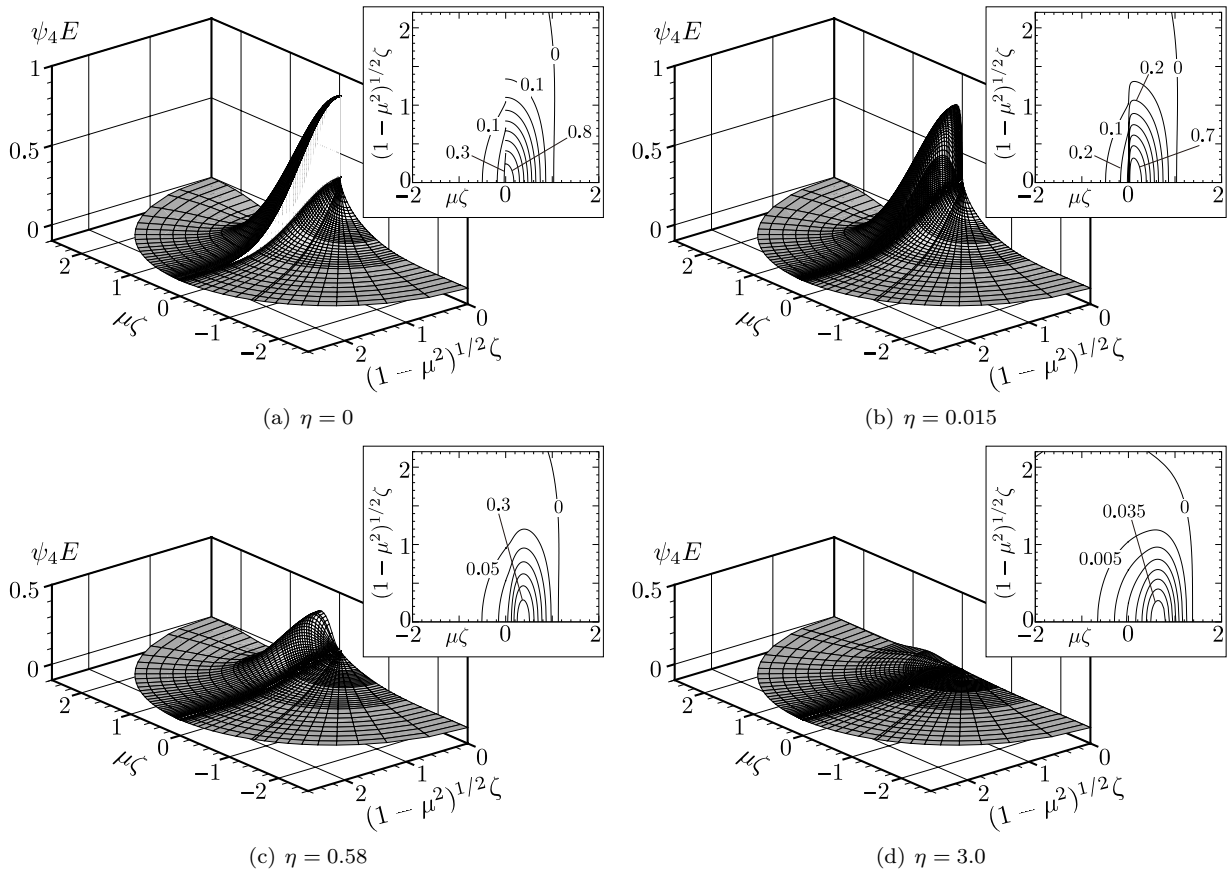

Figure 9: $\psi_4 E$ for the HS gas under the diffuse reflection condition and its contour plots at four spatial points. (a) $\eta = 0$, (b) $\eta = 0.015$, (c) $\eta = 0.58$, and (d) $\eta = 3.0$. In the contour plots, the curves are drawn with the intervals 0.1 in (a) and (b), 0.05 in (c), and 0.005 in (d). The white vertical surface at $\mu\zeta = 0$ in (a) shows the discontinuity.

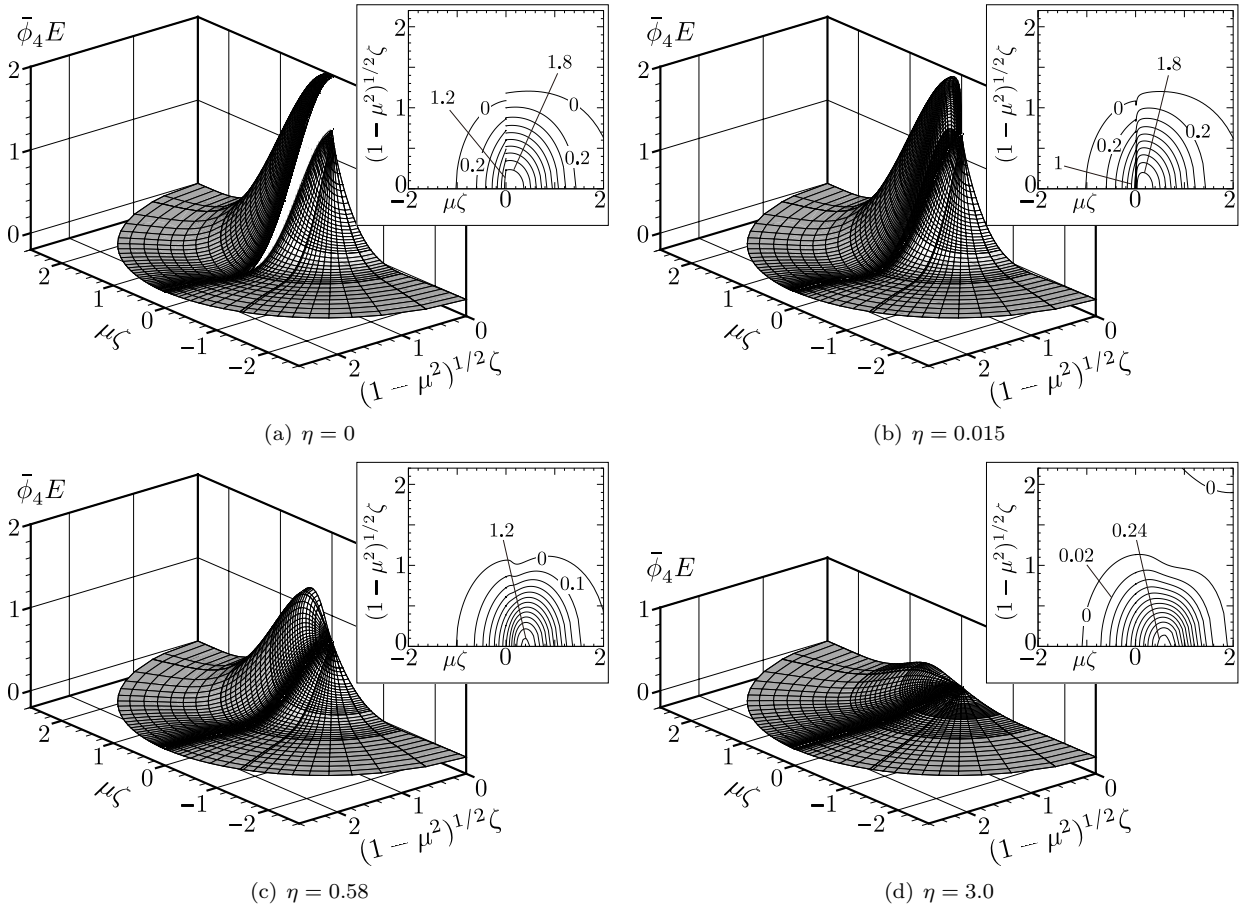

Figure 10: $\bar{\phi}_4 E$ for the HS gas under the diffuse reflection condition and its contour plots at four spatial points. (a) $\eta = 0$, (b) $\eta = 0.015$, (c) $\eta = 0.58$, and (d) $\eta = 3.0$. In the contour plots, the curves are drawn with the intervals 0.2 in (a) and (b), 0.1 in (c), and 0.02 in (d). The white vertical surface at $\mu\zeta = 0$ in (a) shows the discontinuity.

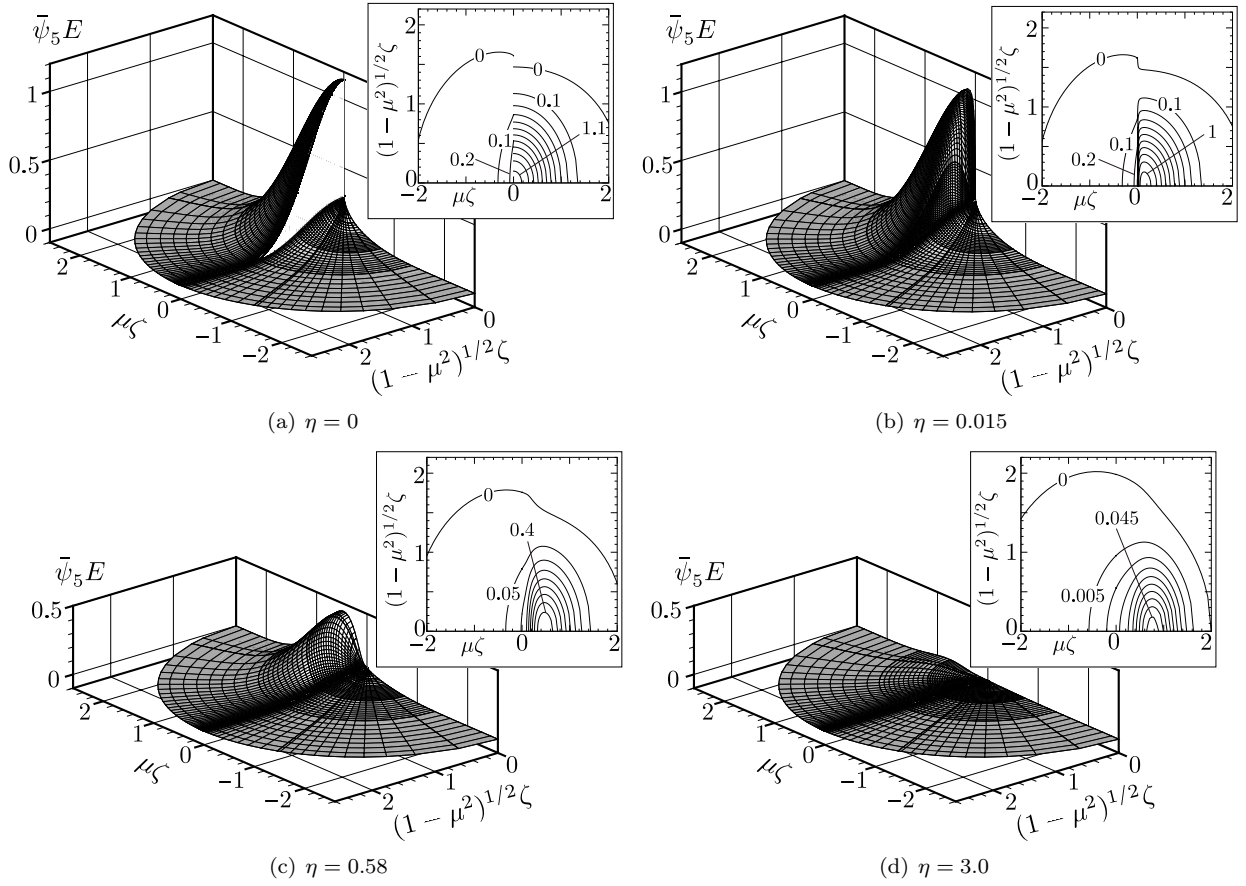

Figure 11: $\bar{\psi}_5 E$ for the HS gas under the diffuse reflection condition and its contour plots at four spatial points. (a) $\eta = 0$, (b) $\eta = 0.015$, (c) $\eta = 0.58$, and (d) $\eta = 3.0$. In the contour plots, the curves are drawn with the intervals 0.1 in (a) and (b), 0.05 in (c), and 0.005 in (d). The white vertical surface at $\mu\zeta = 0$ in (a) shows the discontinuity.

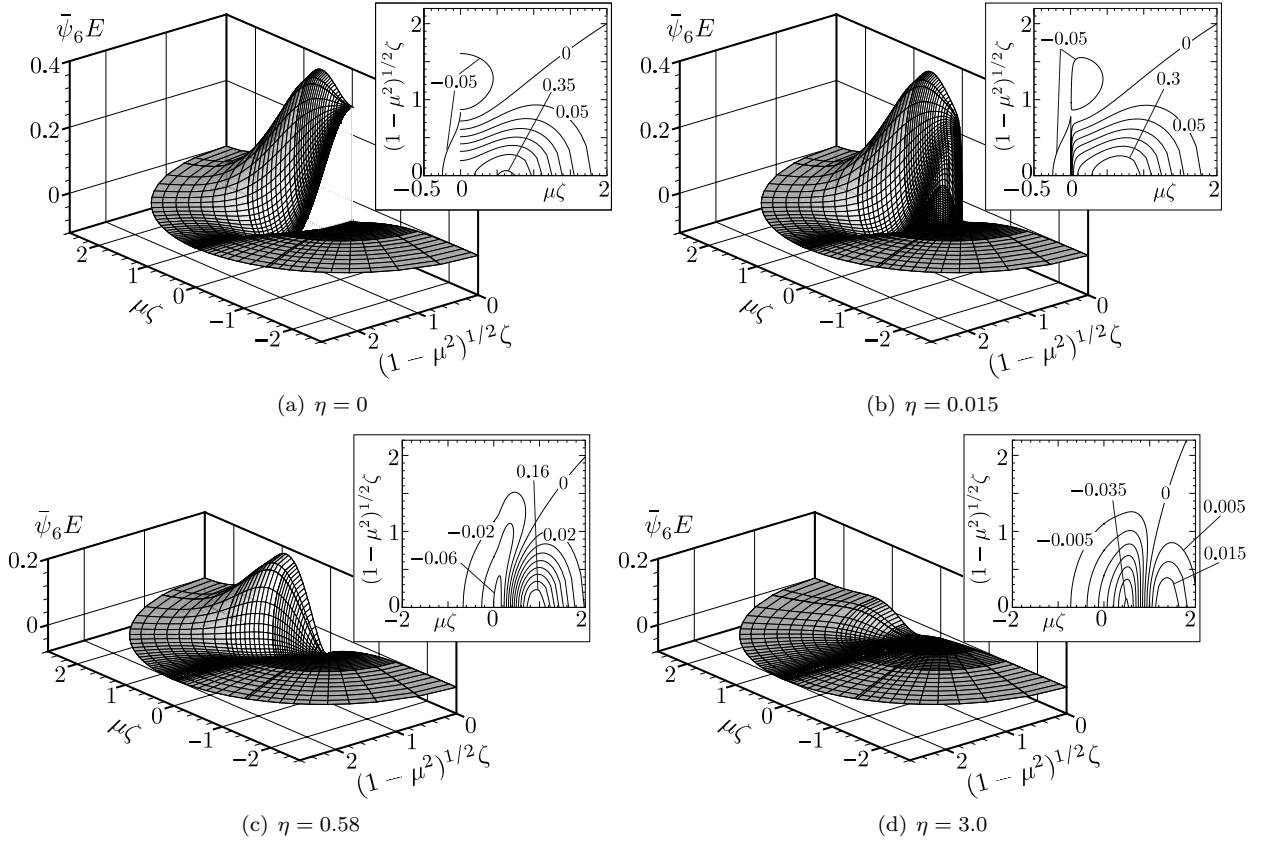

Figure 12: $\bar{\psi}_6 E$ for the HS gas under the diffuse reflection condition and its contour plots at four spatial points. (a) $\eta = 0$, (b) $\eta = 0.015$, (c) $\eta = 0.58$, and (d) $\eta = 3.0$. In the contour plots, the curves are drawn with the intervals 0.05 in (a) and (b), 0.02 in (c), and 0.005 in (d). The white vertical surface at $\mu\zeta = 0$ in (a) shows the discontinuity.

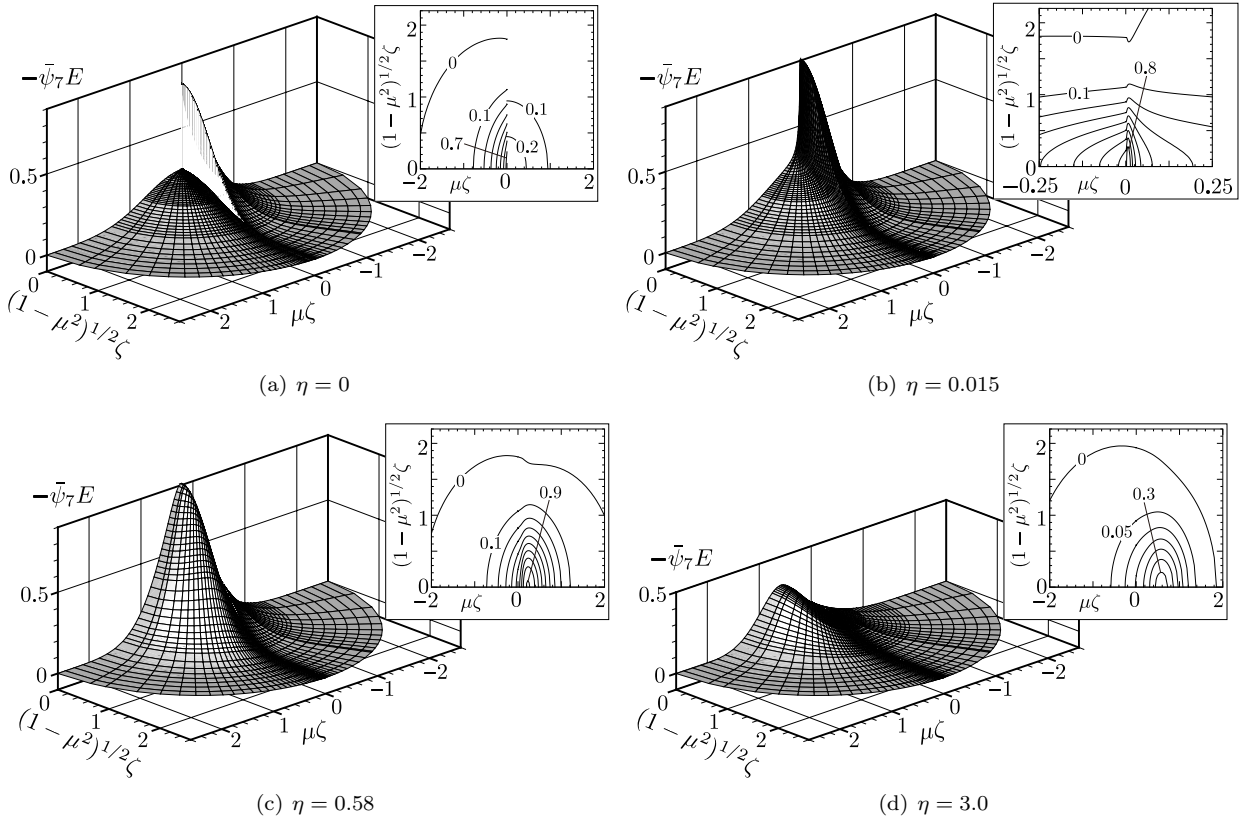
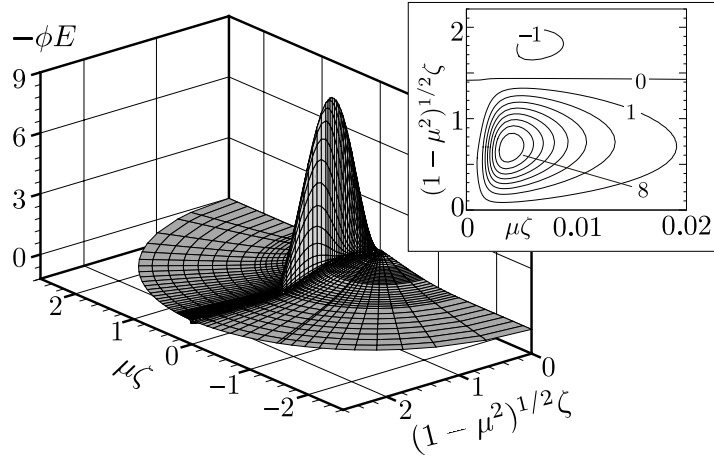
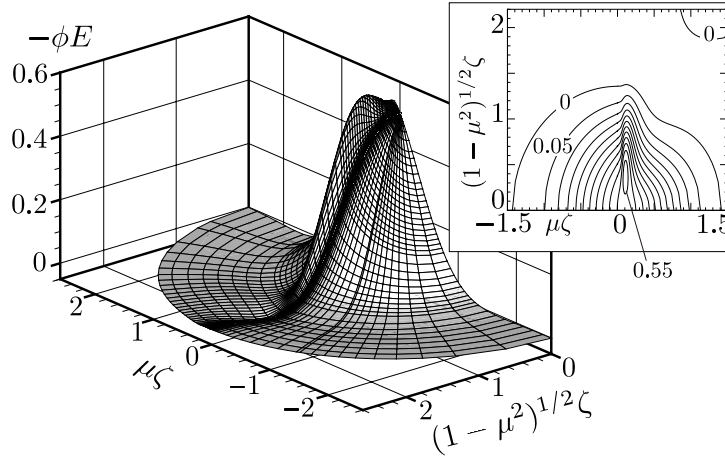

Figure 13: $\bar{\psi}_7 E$ for the HS gas under the diffuse reflection condition and its contour plots at four spatial points. (a) $\eta = 0$, (b) $\eta = 0.015$, (c) $\eta = 0.58$, and (d) $\eta = 3.0$. In the contour plots, the curves are drawn with the intervals 0.1 in (a), (b), and (c), and 0.05 in (d). The white vertical surface at $\mu\zeta = 0$ in (a) shows the discontinuity.



(a) $\eta = 0.015$



(b) $\eta = 0.58$

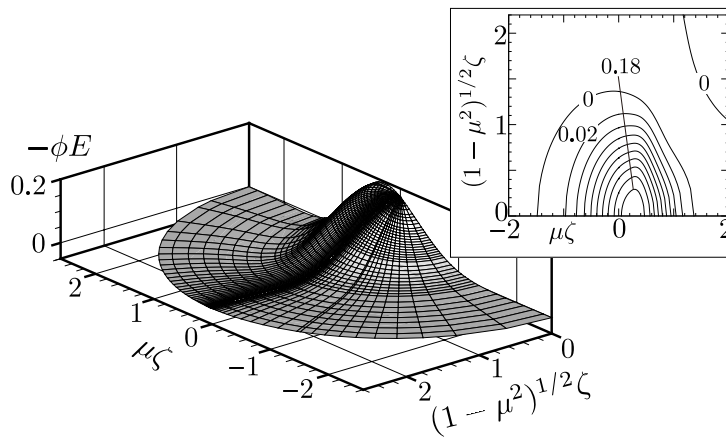

(c) $\eta = 3.0$

Figure 14: ϕE for the HS gas under the diffuse reflection condition and its contour plots at three spatial points. (a) $\eta = 0.015$, (b) $\eta = 0.58$, and (c) $\eta = 3.0$. In the contour plots, the curves are drawn with the intervals 1 in (a), 0.05 in (b), and 0.02 in (c).

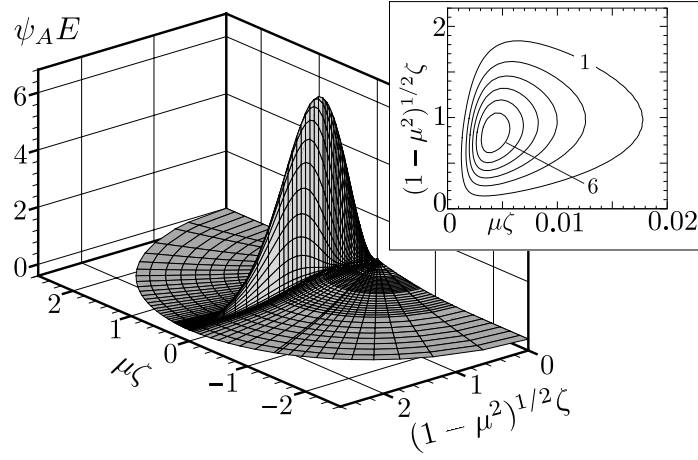

(a) $\eta = 0.015$

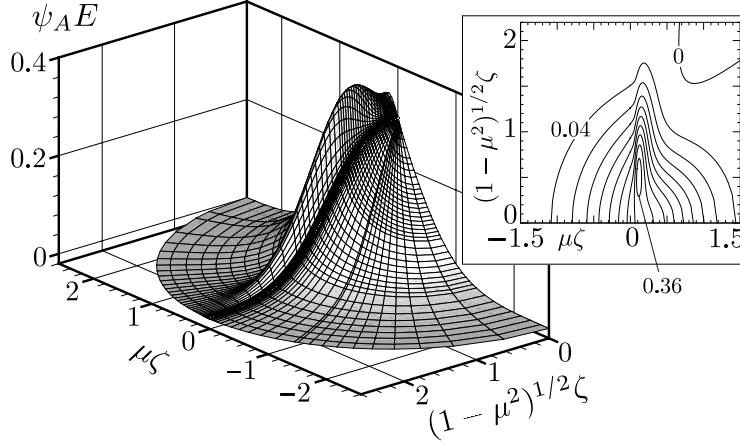

(b) $\eta = 0.58$

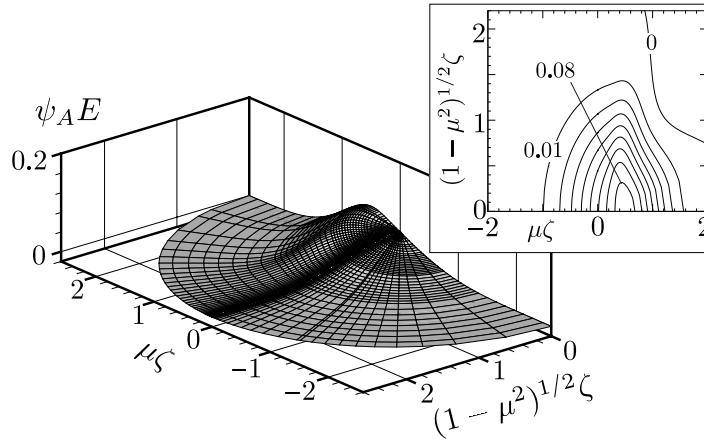

(c) $\eta = 3.0$

Figure 15: ψ_{AE} for the HS gas under the diffuse reflection condition and its contour plots at three spatial points. (a) $\eta = 0.015$, (b) $\eta = 0.58$, and (c) $\eta = 3.0$. In the contour plots, the curves are drawn with the intervals 1 in (a), 0.04 in (b), and 0.01 in (c).

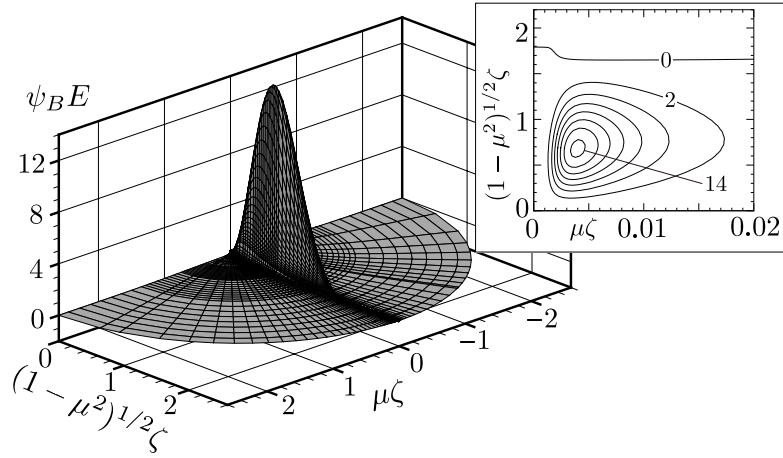

(a) $\eta = 0.015$

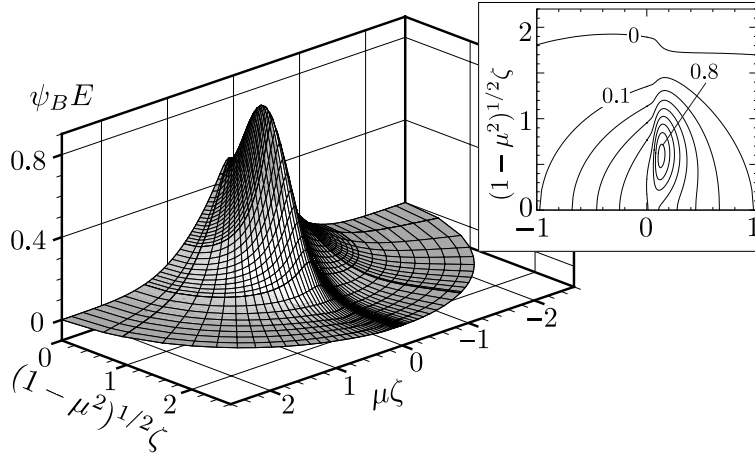

(b) $\eta = 0.58$

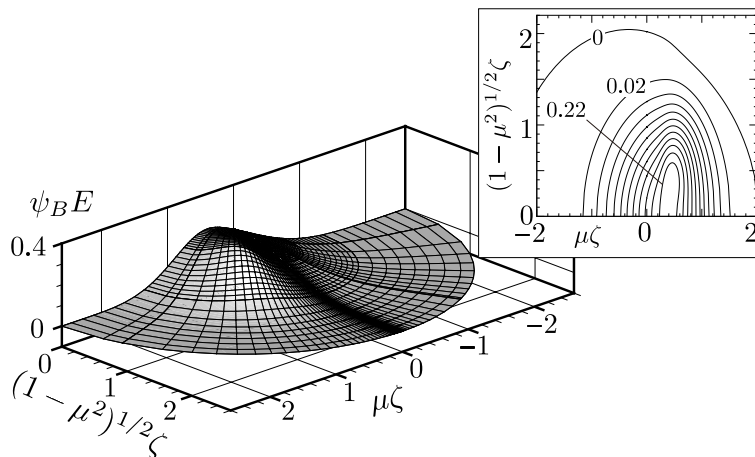

(c) $\eta = 3.0$

Figure 16: ψ_{BE} for the HS gas under the diffuse reflection condition and its contour plots at three spatial points. (a) $\eta = 0.015$, (b) $\eta = 0.58$, and (c) $\eta = 3.0$. In the contour plots, the curves are drawn with the intervals 2 in (a), 0.1 in (b), and 0.02 in (c).