

Minimal coloring numbers of \mathbb{Z} -colorable links

Kazuhiro Ichihara and Eri Matsudo

College of Humanities and Sciences, Nihon University

1 Introduction

The aim of this article is to give a summary of the results given in the papers [5, 8, 6] on \mathbb{Z} -colorings of links.

In [3], Fox introduced one of the most well-known invariants for knots and links in the 3-space, now called *the Fox n -coloring*, or simply n -coloring for $n \geq 2$. For example, the tricolorability is much often used to prove that the trefoil is a non-trivial knot. However, some of links are known to admit non-trivial n -colorings for any $n \geq 2$. In fact, if the determinant of a link L is 0, then it is shown that L admits non-trivial n -coloring for any $n \geq 2$. (For example, see [5] for the definition of the determinant of a link.) In that case, L admits a generalization of the Fox n -coloring, which we call a \mathbb{Z} -coloring defined as follows.

Definition 1. Let L be a link and D a regular diagram of L . We consider a map $\gamma : \{\text{arc of } D\} \rightarrow \mathbb{Z}$. If γ satisfies the condition $2\gamma(a) = \gamma(b) + \gamma(c)$ at each crossing of D with the over arc a and the under arcs b and c , then γ is called a \mathbb{Z} -coloring on D . A \mathbb{Z} -coloring which assigns the same value to all the arcs of the diagram is called a *trivial \mathbb{Z} -coloring*. A link is called \mathbb{Z} -colorable if it has a diagram admitting a non-trivial \mathbb{Z} -coloring.

In the following, we call the integers of the image of a \mathbb{Z} -coloring *colors* as usual.

The links illustrated in Figures 1 and 2 are examples those are \mathbb{Z} -colorable. Throughout this paper, we adopt the names of links as those given in [2].

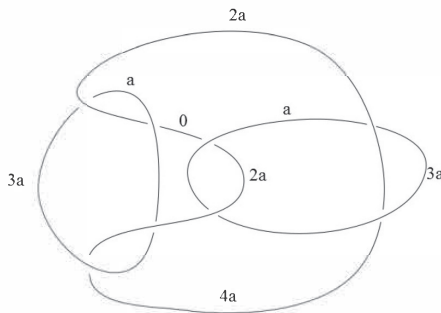

Figure 1: $L8n6$ ($a \geq 1$)

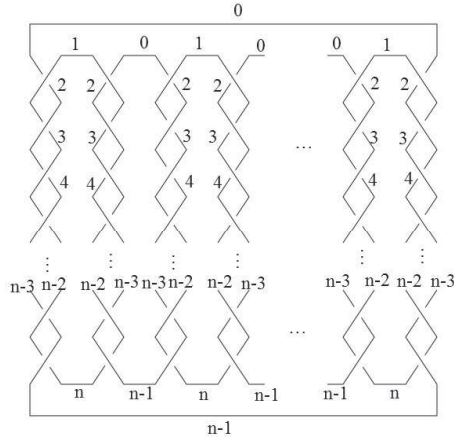

Figure 2: Pretzel link $P(n, -n, \dots, n, -n)$ for $n \geq 1$

There are a lot of researches on Fox colorings of links. Among them, in [4], Harary and Kauffman originally defined the minimal coloring number for a link as the minimal number of colors used in Fox colorings of the link. Since then, it has been studied in details by many researchers. Actually, the minimal numbers of colors for n -colorable knots and links behave interestingly, and are often hard to determine.

Here we define the minimal coloring number for \mathbb{Z} -colorable links as a generalization.

Definition 2. Let us consider the cardinality of the image of a non-trivial \mathbb{Z} -coloring on a diagram of a \mathbb{Z} -colorable link L . We call the minimum of such cardinalities among all non-trivial \mathbb{Z} -colorings on all diagrams of L the *minimal coloring number* of L , and denote it by $\text{mincol}_{\mathbb{Z}}(L)$.

In Section 2, we collect some preliminary results on \mathbb{Z} -colorings. For example, we see that the minimal coloring number of any splittable \mathbb{Z} -colorable link is shown to be 2, and for a non-splittable \mathbb{Z} -colorable link L , we show that $\text{mincol}_{\mathbb{Z}}(L) \geq 4$. That is, there are no links with the minimal coloring number 3.

Next, based on observations for \mathbb{Z} -colorable link with at most 9 crossings, we introduce a *simple* \mathbb{Z} -coloring in Section 3, and show that if a link L admits a simple \mathbb{Z} -coloring, then $\text{mincol}_{\mathbb{Z}}(L) = 4$.

In Section 4, we actually show that any non-splittable \mathbb{Z} -colorable link has a diagram with a simple \mathbb{Z} -coloring, and its minimal coloring number is always four. Remark that this result is also proved by Meiqiao Zhang, Xian'an Jin and Qingying Deng almost independently in [9].

In the proof of the above result, we give a procedure to obtain a diagram with a \mathbb{Z} -coloring of four colors from any given diagram with a non-trivial \mathbb{Z} -coloring of a non-splittable \mathbb{Z} -colorable link. However, from a given diagram of a \mathbb{Z} -colorable link, by using

the procedure given in the our proof, the obtained diagram and \mathbb{Z} -coloring might be very complicated.

In Section 5, we give “simple” diagrams with \mathbb{Z} -colorings of four colors for some particular class of \mathbb{Z} -colorable link. In fact, we consider the link obtained by replacing each component of the given link with several parallel strands, which we call a parallel of a link.

Finally, in Section 6, we consider the question, for a \mathbb{Z} -colorable link, how many colors are necessary for their “simple” diagrams. Actually, we consider the minimal coloring numbers of *minimal diagrams* of \mathbb{Z} -colorable links, that is, the diagrams representing the link with least number of crossings. We first show that, for any positive integer N , there exists a non-splittable \mathbb{Z} -colorable link with a minimal diagram admitting only \mathbb{Z} -colorings with at least N colors. In fact, the examples are given by families of pretzel links; $P(n, -n, n, -n, \dots, n, -n)$ with at least 4 strands, $P(-n, n + 1, n(n + 1))$ with a positive integer n . On the other hand, by considering some particular subfamily, as a corollary, we have the following. There exists an infinite family of \mathbb{Z} -colorable pretzel links each of which has a minimal diagram admitting a \mathbb{Z} -coloring with only four colors. Also we give such examples given by some of \mathbb{Z} -colorable torus links.

2 Preliminaries

In this section, we prepare some basic properties of \mathbb{Z} -colorings.

Lemma 1. *For any \mathbb{Z} -colorable link, there exists a \mathbb{Z} -coloring γ such that $Im(\gamma) = \{0, a_1, a_2, \dots, a_n\}$ with $a_i > 0$ ($i = 1, 2, \dots, n$) for some positive integer n .*

Lemma 2. *For a \mathbb{Z} -coloring γ with $0 = \min Im(\gamma)$, if an over arc at a crossing is colored by 0, then the under arcs at the crossing are colored by 0.*

Lemma 3. *For a \mathbb{Z} -coloring γ with $M = \max Im(\gamma)$, if an over arc at a crossing is colored by M , then the under arcs at the crossing are colored by M .*

It is seen that any splittable link L is \mathbb{Z} -colorable and $mincol_{\mathbb{Z}}(L) = 2$. On the other hand, by using above lemmas, we see that the next holds for non-splittable links.

Theorem 1. *Let L be a non-splittable \mathbb{Z} -colorable link. Then $mincol_{\mathbb{Z}}(L) \geq 4$.*

If a link is \mathbb{Z} -colorable with four colors, we can show the following.

Theorem 2. *If $mincol_{\mathbb{Z}}(L) = 4$ for a \mathbb{Z} -colorable link L , then there exists a diagram D of L and a \mathbb{Z} -coloring γ on D such that $Im(\gamma) = \{0, 1, 2, 3\}$.*

3 Simple coloring

Among links of crossing numbers at most 9, there are only 5 links with zero determinant. For such \mathbb{Z} -colorable links, the colorings on the diagrams in [2] are quite distinctive.

In this section, we focus on the “simplest” \mathbb{Z} -coloring found for the links with at most 9 crossings. Based on such examples, we introduce the following notion.

Definition 3. Let L be a non-trivial \mathbb{Z} -colorable link, and γ a \mathbb{Z} -coloring on a diagram D of L . We call γ a *simple* \mathbb{Z} -coloring if there exists an integer d such that, at each crossing in D , the difference between the colors of the over arc and the under arcs is d or 0 .

For example, a pretzel knot $P(n, -n, n, -n, \dots, n, -n)$ with integer n admits a simple \mathbb{Z} -coloring. See Figure 2.

For the links with simple \mathbb{Z} -colorings, we have the following.

Theorem 3. [6, Theorem 4.2] *Let L be a non-splittable \mathbb{Z} -colorable link. If there exists a simple \mathbb{Z} -coloring on a diagram of L , then $\text{mincol}_{\mathbb{Z}}(L) = 4$.*

The operation illustrated in Figure 3 is a key of the proof of the theorem.

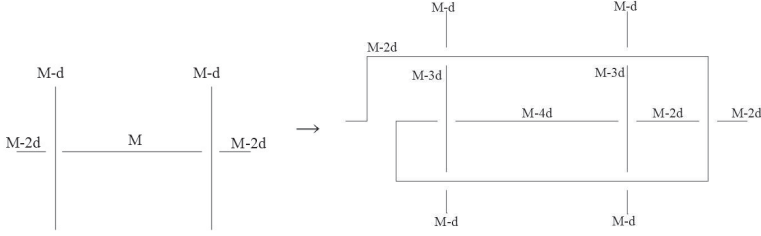

Figure 3:

However, there are many diagrams of \mathbb{Z} -colorable links without simple \mathbb{Z} -colorings. See Figure 4 for example.

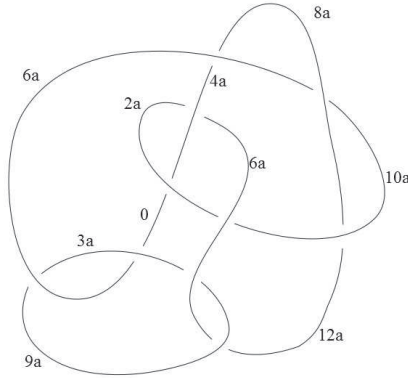

Figure 4: Non-simple \mathbb{Z} -coloring for L_{10n32}

4 Minimal coloring number is four

The next is the main result in this article.

Theorem 4 ([8]). *The minimal coloring number of any non-splittable \mathbb{Z} -colorable link is equal to 4.*

This result is also proved by Meiqiao Zhang, Xian'an Jin and Qingying Deng almost independently in [9]. Previously Zhang gave us her manuscript for her Master thesis. In Zhang's thesis, she calls a crossing an n -diff crossing if $|b - a|$ and $|b - c|$ are equal to n , where the over arc is colored by b and the under arcs are colored by a and c by a \mathbb{Z} -coloring γ at the crossing. Then she showed that if a \mathbb{Z} -colorable link has a diagram with a 1-diff crossing, the link has a diagram with only 0-diff crossings and 1-diff crossings. Our proof of the theorem above is based on her arguments.

The proof of the theorem is achieved by giving a procedure to modify a diagram of a non-splittable \mathbb{Z} -colorable link with a non-simple \mathbb{Z} -coloring to the one with a simple coloring. One of the key moves is illustrated in Figure 5. We here omit the details.

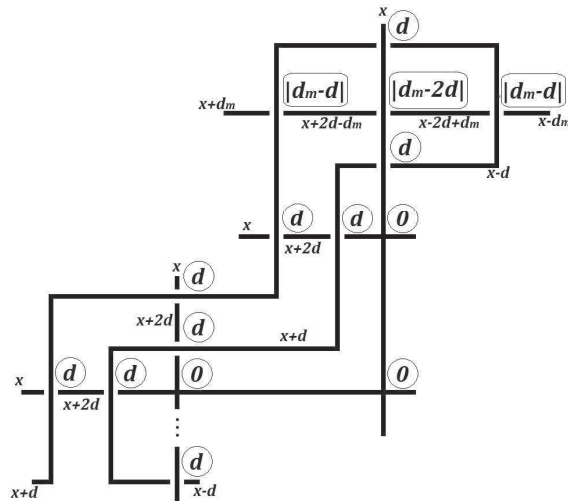

Figure 5:

By Theorem 4, any non-splittable \mathbb{Z} -colorable link has a diagram with a \mathbb{Z} -coloring of 4 colors. However, from a given diagram of a \mathbb{Z} -colorable link, by using the procedure given in the our proof of Theorem 4, the obtained diagram and \mathbb{Z} -coloring might be very complicated.

5 Parallel of link

In this section, we give a simple way to obtain a diagram which attains the minimal coloring number for a particular family of \mathbb{Z} -colorable links. That is, we consider the link obtained by replacing each component of the given link with several parallel strands, which we call a parallel of a link, as follows.

Definition 4. Let $L = K_1 \cup \cdots \cup K_c$ be a link with c components and D a diagram of L . For a set (n_1, \dots, n_c) of integers $n_i \geq 1$, we denote by $D^{(n_1, \dots, n_c)}$ the diagram obtained by taking n_i -parallel copies of the i -th component K_i of D on the plane for $1 \leq i \leq c$. The link $L^{(n_1, \dots, n_c)}$ represented by $D^{(n_1, \dots, n_c)}$ is called *the (n_1, \dots, n_c) -parallel of L* . When L is a knot, that is $c = 1$, we call (n) -parallel $L^{(n)}$ simply a n -parallel, and denote it by L^n . We call a 2-parallel of a knot *untwisted* if the linking number of the 2 components of the parallel is 0.

Examples of (n_1, \dots, n_c) -parallels of links are shown in Figures 6 and 7.

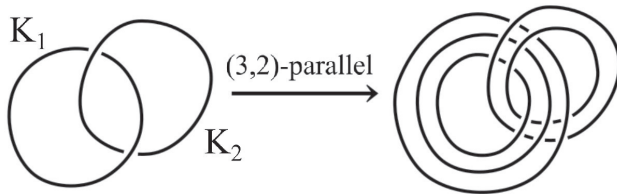

Figure 6: A $(3, 2)$ -parallel of the Hopf link

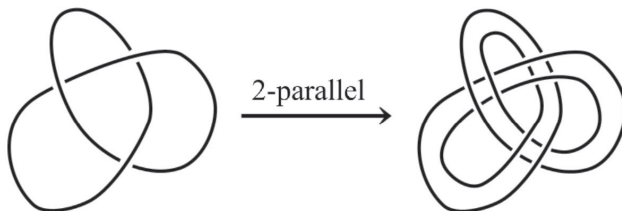

Figure 7: A 2-parallel of the trefoil

We show that an even parallel of a link is \mathbb{Z} -colorable except for the case of 2 parallels with non-zero linking number.

Theorem 5. (i) For a non-trivial knot K and any diagram D of K that the writhe is 0, D^2 always represents a \mathbb{Z} -colorable link. Moreover, there exists a diagram D_0 of K such that D_0^2 is locally equivalent to a minimally \mathbb{Z} -colorable diagram. (ii) Let L be a non-splittable c -component link and D any diagram of L . For any even number n_1, \dots, n_c at least 4, $D^{(n_1, \dots, n_c)}$ always represents a \mathbb{Z} -colorable link and is locally equivalent to a minimally \mathbb{Z} -colorable diagram.

Here we give the definitions used in Theorem 5.

Definition 5. Let L be a \mathbb{Z} -colorable link, and D a diagram of L . D is called a *minimally \mathbb{Z} -colorable diagram* if there exists a \mathbb{Z} -coloring γ on D such that the image of γ is equal to the minimal coloring number of L .

Definition 6. For diagrams D and D' of L , D is *locally equivalent* to D' if there exist mutually disjoint open subsets on \mathbb{R}^2 U_1, U_2, \dots, U_n such that D' is obtained from D by Reidemeister moves only in $\bigcup_{i=1}^m U_i$.

To prove Theorem 5 (i), we prepare the next lemma about the linking number of components of 2-parallel of a knot.

Lemma 4. *Let D a diagram of a knot K . For a 2-parallel $K^2 = K_1 \cup K_2$ represented by D^2 , the linking number of K_1 and K_2 is equal to the writhe of D .*

For non-splittability of parallels of knots and links, we can also show the next.

Lemma 5. (i) *Any n -parallel of a non-trivial knot is non-splittable. (ii) Any (n_1, \dots, n_c) -parallel of a non-splittable link is non-splittable.*

To prove Theorem 5, we actually give \mathbb{Z} -colorings with four colors on the paralleled diagrams. For the case of (ii), the colorings are illustrated in Figures 8, 9, and 10 with modifications depicted in Figure 11.

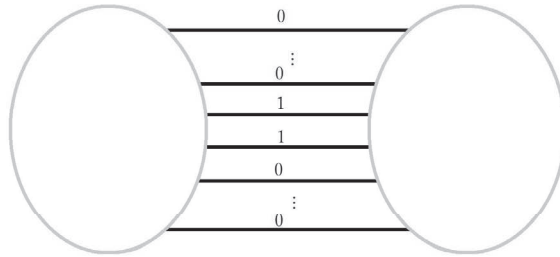

Figure 8:

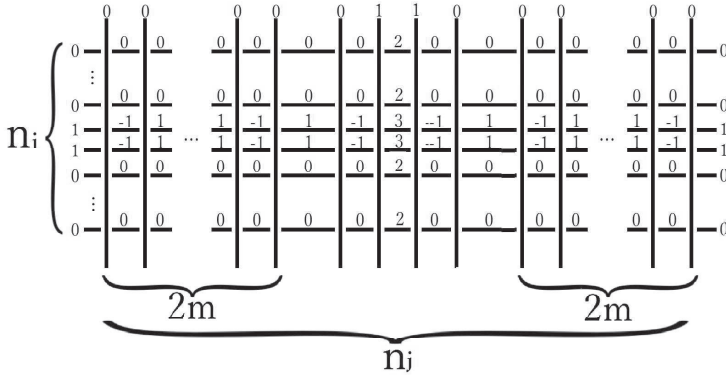

Figure 9: $n_j = 4m$ for some integer m

Figure 10: $n_j = 4m + 2$ 

Figure 11: Delete the color 3

6 Minimal diagrams

In this section, we consider the minimal coloring numbers of *minimal diagrams* of \mathbb{Z} -colorable links, that is, the diagrams representing the link with least number of crossings.

6.1 Pretzel links

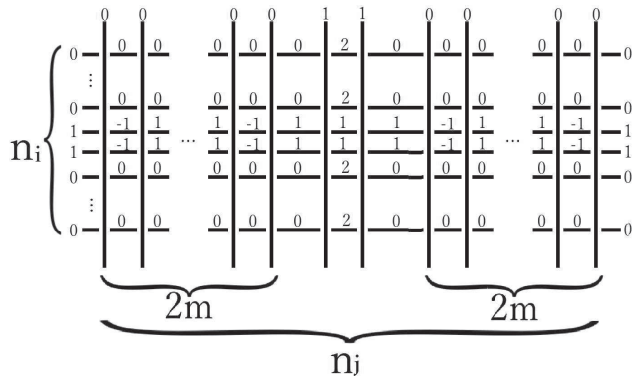
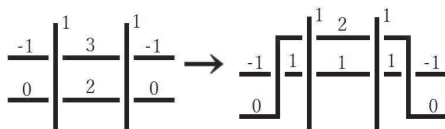
In this section, we first prove the next theorem.

Theorem 6. *For an even integer $n \geq 2$, the pretzel link $P(n, -n, \dots, n, -n)$ with at least 4 strands has a minimal diagram admitting only \mathbb{Z} -colorings with $n + 2$ colors.*

Here a *pretzel link* $P(a_1, \dots, a_n)$ is defined as a link admitting a diagram consisting rational tangles corresponding to $1/a_1, 1/a_2, \dots, 1/a_n$ located in line. Such a pretzel link $P(n, -n, \dots, n, -n)$ is known to be non-splittable if $n \geq 2$ and the number of strands is at least 4.

The pretzel link $P(n, -n, \dots, n, -n)$ is \mathbb{Z} -colorable since its determinant is 0 for the link. See [1] for example.

We consider the diagram of $P(n, -n, \dots, n, -n)$ illustrated in Figure 12, which is a minimal diagram of the link due to the result in [7]. For this diagram, as shown in the figure, we can find a \mathbb{Z} -coloring with the colors $0, a, 2a, \dots, (n + 1)a$. It can be shown

that any \mathbb{Z} -coloring must have such colors, that is, the minimal coloring number of the diagram is equal to $n + 2$.

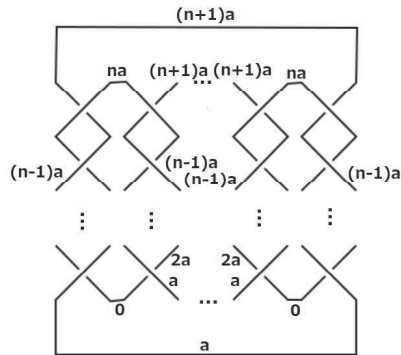

Figure 12:

On the other hand, by considering some particular subfamily, as a corollary, we see that there exists an infinite family of \mathbb{Z} -colorable pretzel links each of which has a minimal diagram admitting a \mathbb{Z} -coloring with only four colors as follows.

We consider the pretzel link $P(2, -2, 2, -2, \dots, 2, -2)$. The diagram depicted in Figure 13 is a minimal diagram by [7]. On the other hand, the \mathbb{Z} -coloring given in the figure has only four colors $\{0, 1, 2, 3\}$.

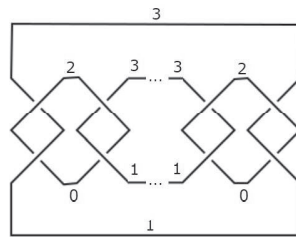

Figure 13:

Next we consider the pretzel link $P(-n, n + 1, n(n + 1))$ for an integer $n \geq 2$, and show the following.

Theorem 7. *For an integer $n \geq 2$, the pretzel link $P(-n, n + 1, n(n + 1))$ has a minimal diagram admitting only \mathbb{Z} -colorings with $n^2 + n + 3$ colors.*

Such pretzel links are all \mathbb{Z} -colorable by [1] for example. In fact, the determinant of the link $P(-n, n + 1, n(n + 1))$ is calculated as $|(-n) \cdot (n + 1) + (-n) \cdot n(n + 1) + (n + 1) \cdot n(n + 1)| = 0$.

This theorem can be proved in the same way as for Theorem 6.

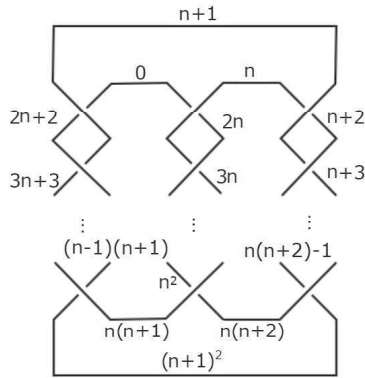

Figure 14:

6.2 Torus links

In this subsection, we consider *torus links*, that is, the links which can be isotoped onto the standardly embedded torus in the 3-space. By $T(a, b)$, we mean the torus link running a times meridionally and b times longitudinally.

Theorem 8. *For even integer $n > 2$ and non-zero integer p , the torus link $T(pn, n)$ has a minimal diagram admitting a \mathbb{Z} -coloring with only four colors.*

To prove the theorem above, we actually give \mathbb{Z} -colorings with four colors on the standard diagrams of torus links. We here only include a figure (Figure 15) to give such colorings.

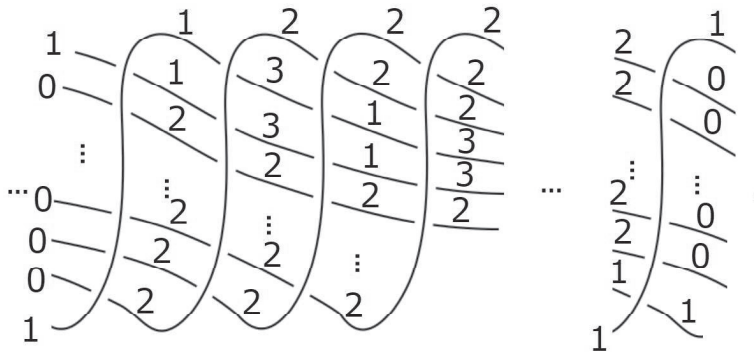

Figure 15:

Acknowledgement

We would like to thank Meiqiao Zhang for useful discussions. We also thank Akio Kawauchi for giving me the motivation that I consider about parallels, and to Kouki Taniyama for pointing out the necessity of Lemmas 5. We are also grateful to Ayumu Inoue, Takuji Nakamura and Shin Satoh for useful discussions and advices. Finally we would like to thank to the anonymous referee for his/her careful reading and pointing out a gap in our proof of a theorem in [6].

References

- [1] O. T. Dasbach, D. Futer, E. Kalfagianni, X.-S. Lin, and N. W. Stoltzfus, Alternating sum formulae for the determinant and other link invariants, *J. Knot Theory Ramifications* **19** (2010), no. 6, 765–782.
- [2] J. C. Cha and C. Livingston, LinkInfo: Table of Knot Invariants, <http://www.indiana.edu/~linkinfo>, (January 13, 2016).
- [3] R. H. Fox, A quick trip through knot theory, in *Topology of 3-manifolds and related topics (Proc. The Univ. of Georgia Institute, 1961)*, 120–167, Prentice Hall, Englewood Cliffs, NJ.
- [4] F. Harary and L. H. Kauffman, Knots and graphs. I. Arc graphs and colorings, *Adv. in Appl. Math.* **22** (1999), no. 3, 312–337.
- [5] K. Ichihara and E. Matsudo, A lower bound on minimal number of colors for links, *Kobe J. Math.* **33** (2016), no. 1-2, 53–60.
- [6] K. Ichihara and E. Matsudo, Minimal coloring number for \mathbb{Z} -colorable links, *J. Knot Theory Ramifications* **26** (2017), no. 4, 1750018, 23 pp.
- [7] W. B. R. Lickorish and M. B. Thistlethwaite, Some links with nontrivial polynomials and their crossing-numbers, *Comment. Math. Helv.* **63** (1988), no. 4, 527–539.
- [8] E. Matsudo, Minimal coloring number for \mathbb{Z} -colorable links II, preprint, arXiv:1705.07567v3
- [9] M. Zhang, X. Jin and Q. Deng, The minimal coloring number of any non-splittable \mathbb{Z} -colorable link is four, *J. Knot Theory Ramifications* **26** (2017), no. 13, 1750084, 18 pp.

Department of Mathematics
 College of Humanities and Sciences
 Nihon University
 3-25-40 Sakurajosui, Setagaya-ku, Tokyo 156-8550
 JAPAN
 E-mail address: ichihara@math.chs.nihon-u.ac.jp

Graduate School of Integrated Basic Sciences,
Nihon University,
3-25-40 Sakurajosui, Setagaya-ku, Tokyo 156-8550
JAPAN
E-mail address: cher16001@g.nihon-u.ac.jp

日本大学文理学部数学科 市原一裕
日本大学大学院総合基礎科学研究科 松土恵理