

# Cooling and Electrical Tests on a 30 KVA Superconducting Synchronous Generator

By

Takao OKADA, Tanzo NITTA and Takeshi KATO

(Received March 31, 1978)

## Abstract

Cooling and electrical tests on a 30 KVA superconducting synchronous generator of the revolving armature type were performed.

The method and results of the cooling test, and discussions about it are given in detail.

Five electrical tests were carried out to determine the machine constants of a superconducting synchronous generator. These tests were i) open-circuit test, ii) three-phase short-circuit test, iii) three-phase sudden short-circuit test, iv) slip test, and v) extended slip test. From these experimental results, the values of the machine constants, for example the steady and the transient synchronous reactance, were calculated.

The V-characteristic of the synchronous motor with no load was obtained by a synchronous condenser test.

## 1. Introduction

The advantages to be gained from substituting a superconductor for a copper conductor in the field winding of the synchronous generator stem from the following:

- a) High capacity.
- b) Small size.
- c) Light weight.

From the above advantages, a superconducting synchronous generator is expected to be put into practice. For practical application, it is necessary to solve several technical problems on superconducting synchronous generators.

Several trial superconducting synchronous generators have already been produced<sup>1),2)</sup>, and several tests on these generators have been performed<sup>1),2)</sup>.

We also performed cooling and electrical tests on a 30 KVA superconducting

---

\* Department of Electrical Engineering

synchronous generator of the revolving armature type. The results of the tests are given in this paper.

### 2. 30 KVA Superconducting Generator

The specifications of a 30 KVA superconducting synchronous generator of the revolving armature type are given in Table 1. A cross-sectional drawing of the generator is shown in Fig. 1. The field winding consists of copper-stabilized niobium-titanium, as shown in Table 2. A detailed cross-section of the stator (cryostat) is shown in Fig. 2. The cryostat has 3 liquid level gauges, No. 1~3, and 6 carbon resistors, No. 1~6, as thermometers.

Table 1 Specification of Generator.

Number of Phases	: 3	Connection	: Star
Rated Power	: 30KVA	Number of Poles	: 4
Rated Terminal Voltage	: 100V	Frequency	: 60Hz
Rated Armature Current	: 173A	Rated Speed	: 1800 r. p. m.

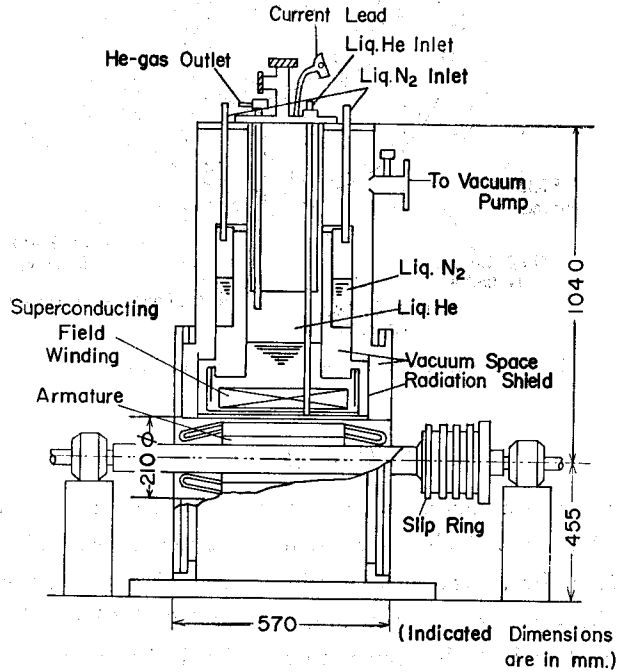

Fig. 1 Cross-Sectional Drawing of the 30 KVA Superconducting Synchronous Generator.

Table 2 Specification of Superconductor.

Cross-Section	: 1.2mm×2.4mm	Cu/Super Ratio	: 7.5
Superconductor	: Nb-Ti	Insulation	: PVF of the width 10-20 $\mu$
Critical Temperature	: 9°K	Critical Current	: 420A (30KG) 300A (50KG)
Number of Filaments	: 10		

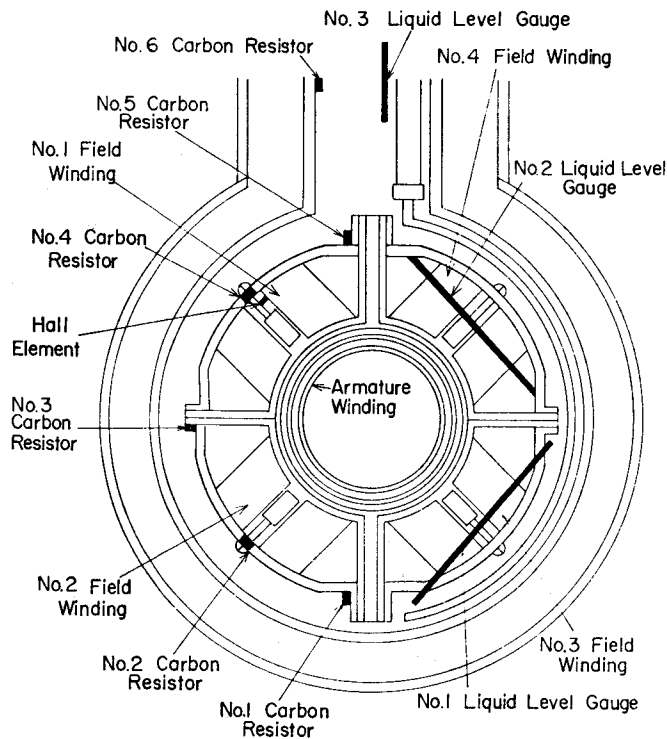

Fig. 2 Detail Cross-Section of the Stator (Cryostat).

### 3. Cooling Test

The field winding of a superconducting generator must operate at a temperature approaching absolute zero. Such a low environment can be maintained by supplying liquid helium (Liq. He). The field winding made of copper-stabilized niobium-titanium can be kept as a superconducting state at 4.2°K (the boiling point of Liq. He). The process, by which the temperature of the field winding goes down to the boiling point of Liq. He, is as follows:

- 1) Evacuating the vacuum space in the cryostat.

The vacuum space in the cryostat had been evacuated 9 days before cooling by Liq. He. When Liq. He flows into the cryostat, the degree of vacuum must be  $10^{-6} \sim 10^{-5}$  mmHg. Table 3 shows the degree of vacuum before precooling by Liq. N<sub>2</sub>.

Table 3 Degree of Vacuum after Beginning of Evacuating

3 PM 21 Nov. 1977	: Beginning of Evacuating
4 PM	: $5.0 \times 10^{-4}$ mmHg
9 AM 22	: $1.3 \times 10^{-4}$
6 PM	: $2.6 \times 10^{-5}$
9 AM 23	: $2.4 \times 10^{-5}$
6 PM	: $9.0 \times 10^{-6}$
9 AM 24	: $2.5 \times 10^{-6}$

2) Precooled by Liq. N<sub>2</sub>.

The cryostat was precooled 6 days before being cooled by Liq. He. After Liq. N<sub>2</sub> was supplied to the Liq. N<sub>2</sub> space, the precooling began. It took 2 hours and 10 minutes to precool the cryostat. During the precooling, the resistance of the field windings changed as shown in Fig. 3. It took an hour and 20 minutes for the resistance of field windings No. 2 and No. 3 to be 0.36 ohm (the resistance at 77°K). After 2 hours, the temperature of the field winding went to the boiling point of Liq. N<sub>2</sub> (77°K). During this process, the degree of vacuum changed as shown in Fig. 4.

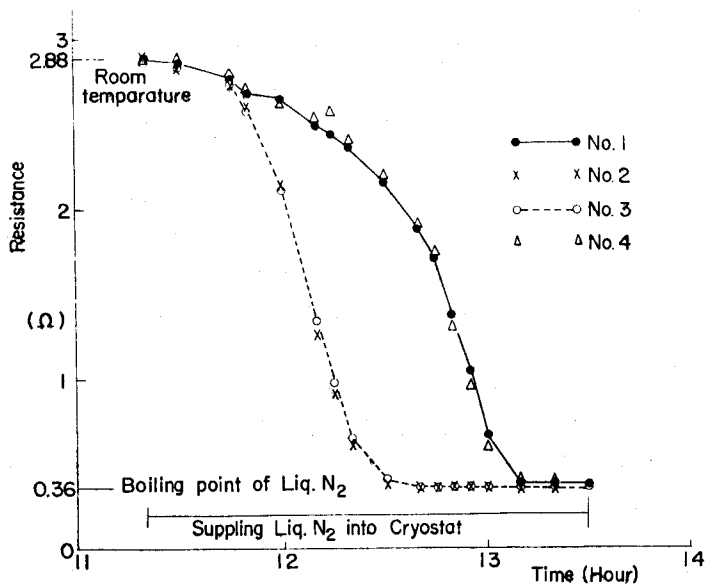

Fig. 3 Resistance of Field Winding at Precooling.

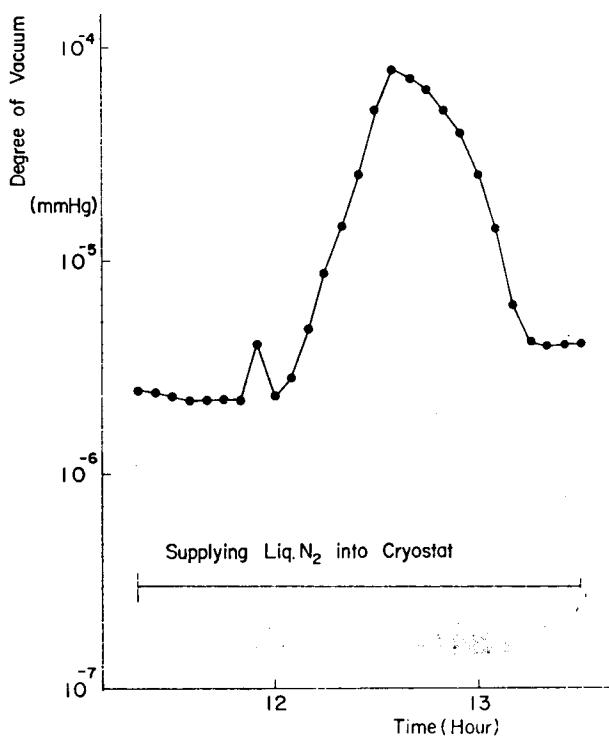

Fig. 4 Degree of Vacuum at Precooling.

3) Exchange of Liq. N<sub>2</sub> for He gas.

Before Liq. He was taken into the cryostat, the exchange of Liq. N<sub>2</sub> for He gas was performed. It took 43 minutes. Since the precooling was not enough, the temperature of the field windings was over the boiling point of Liq. N<sub>2</sub>.

4) Cooled by Liq. He.

Two dewar vessels were arranged. The volume of one is 100 *l* and that of the other is 50 *l*. There were about 93 *l* in the 100 *l*-vessel and about 47 *l* in the 50 *l*-vessel. In the first place, Liq. He was supplied into the cryostat from the 100 *l*-vessel. During the process, the resistance of the field windings changed as shown in Fig. 5. The temperature, at the places on which the carbon resistors were set up, changed as shown in Fig. 6~10. After about 2 hours passed from the beginning of Liq. He-cooling, field windings No. 2 and No. 3 became superconductive. After about 30 minutes later field windings No. 1 and No. 4 became superconductive. The liquid level changed as shown in Fig. 11. After about 2 hours and 20 minutes passed from the beginning, Liq. He began to be condensed in the cryostat. After 40 minutes passed from then, the liquid level was at the bottom of the No. 3-liquid level gauge. During this process, the degree of vacuum changed as shown in Fig. 12.

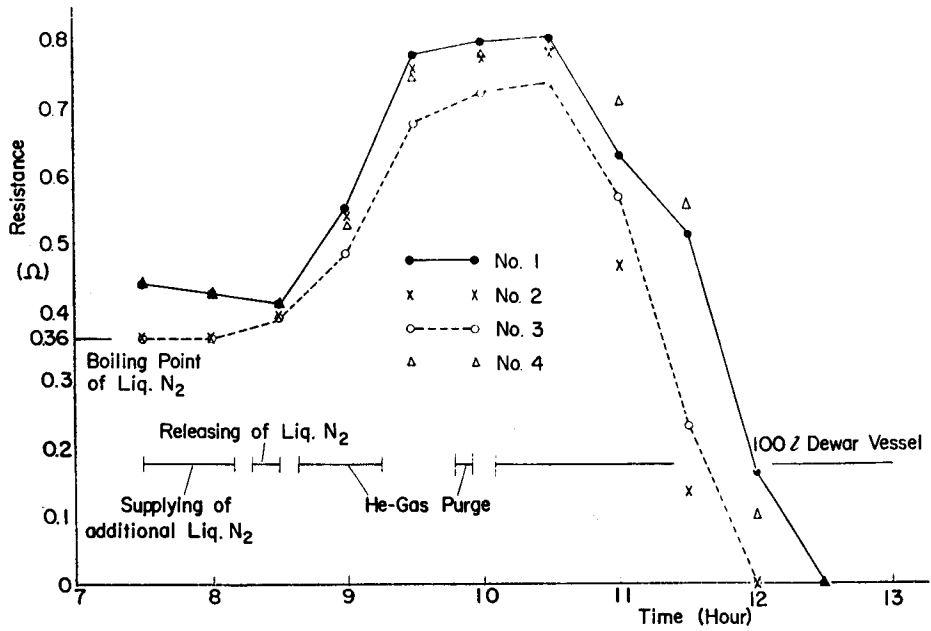

Fig. 5 Resistance of Field Winding.

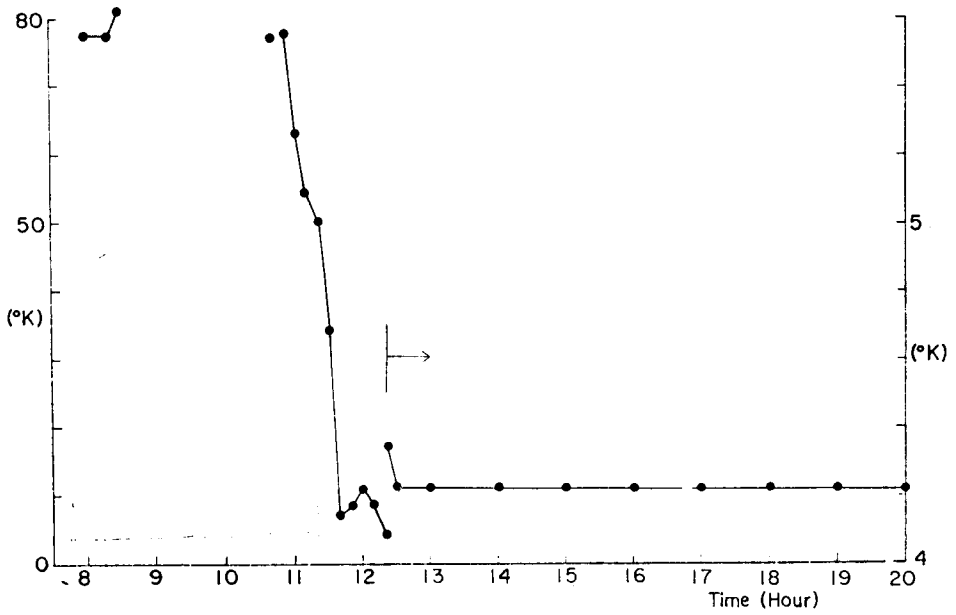

Fig. 6 Temperature at No. 1 Carbon Resistor.

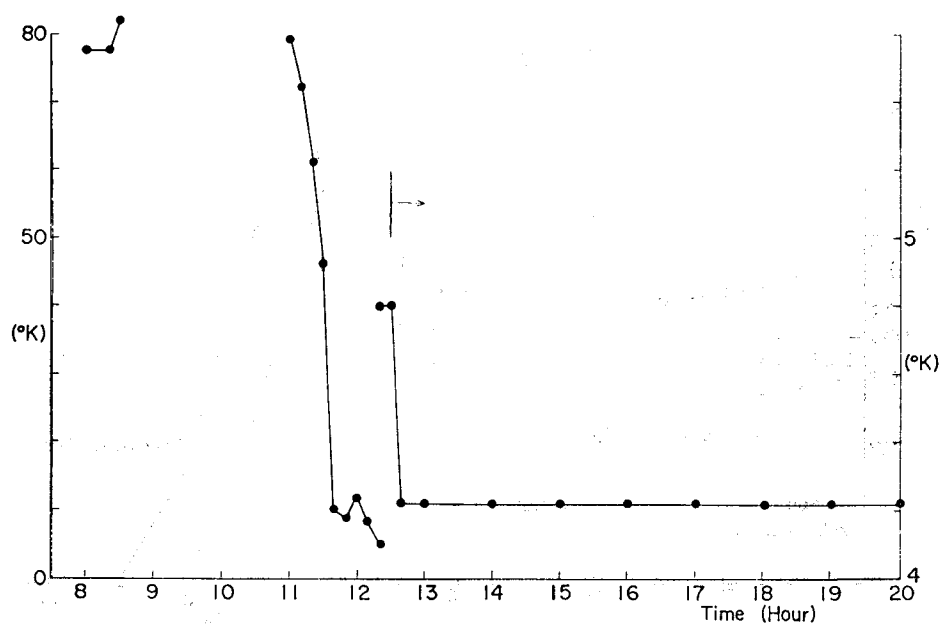

Fig. 7 Temperature at No. 2 Carbon Resistor.

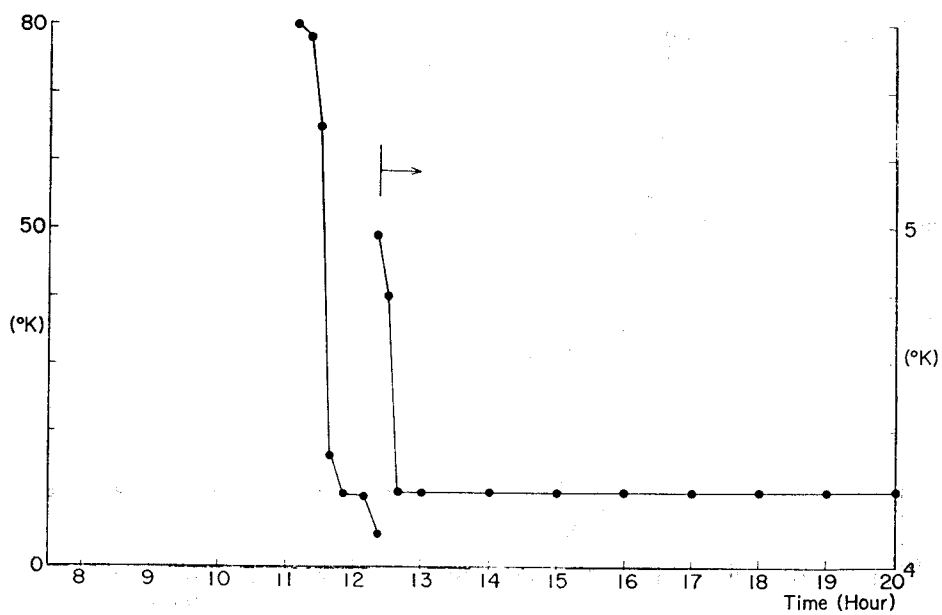

Fig. 8 Temperature at No. 3 Carbon Resistor.

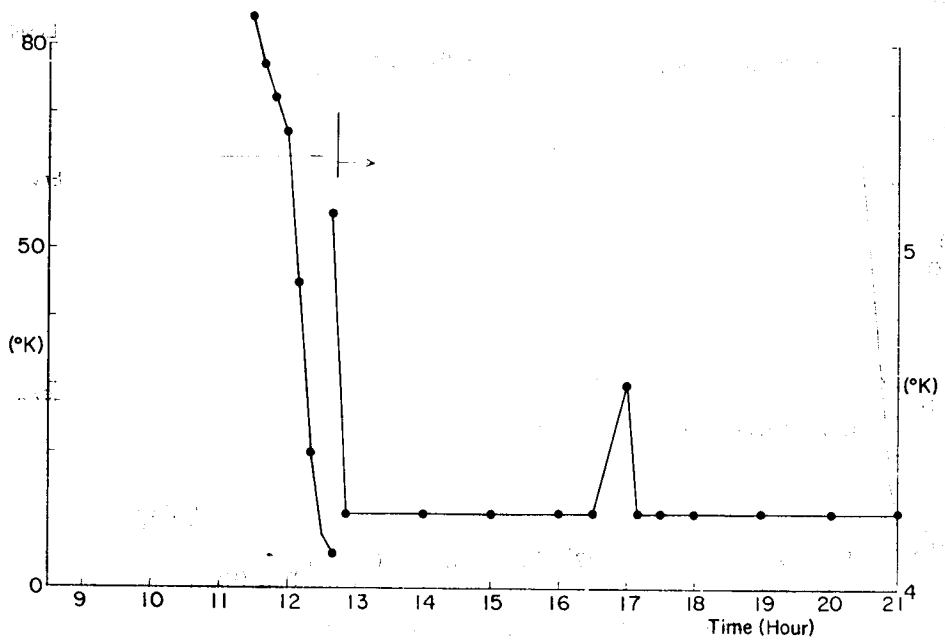

Fig. 9 Temperature at No. 4 Carbon Resistor.

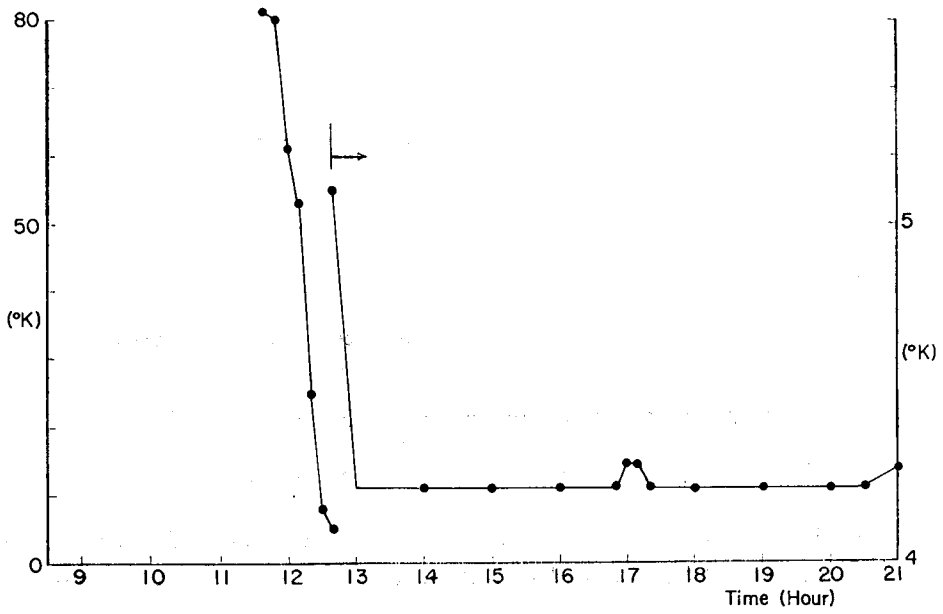

Fig. 10 Temperature at No. 5 Carbon Resistor.



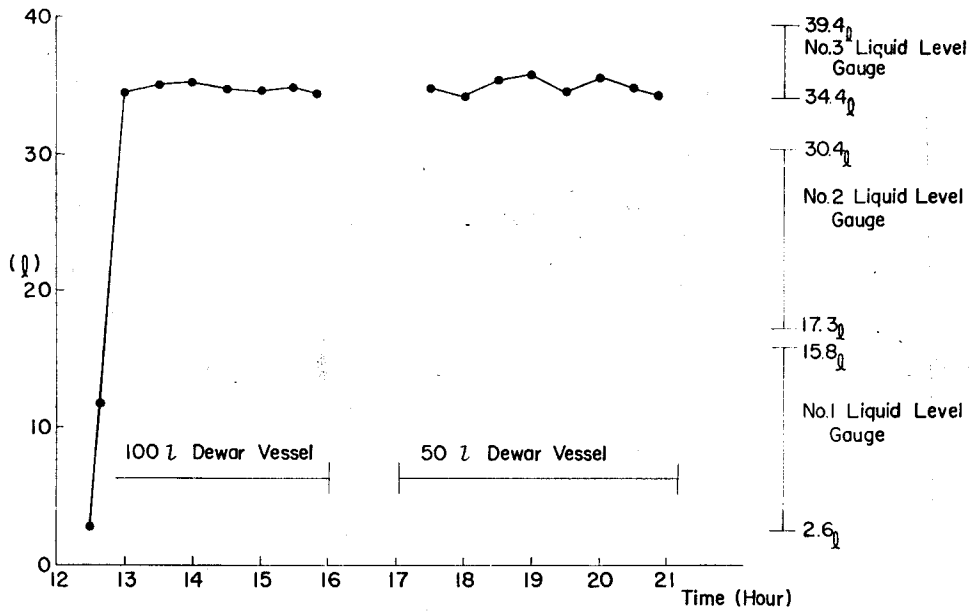

Fig. 11 Amount of Liq. He stored in the Cryostat.

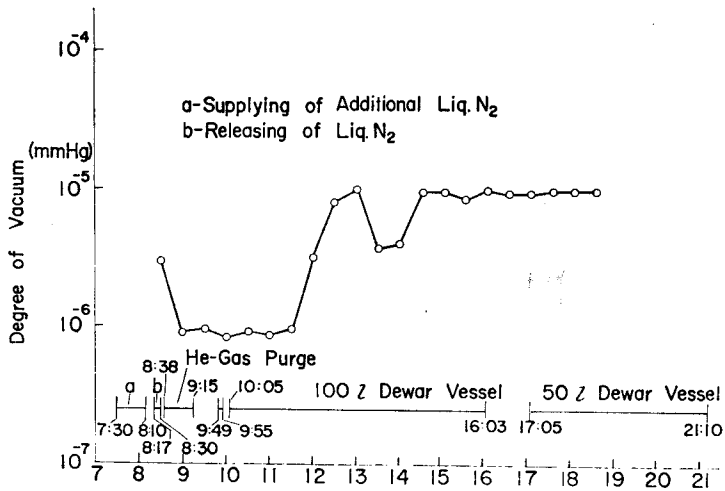

Fig. 12 Degree of Vacuum at Liq. He-cooling.

After 6 hours passed from the beginning, Liq. He was supplied from the 50 l dewar vessel. After 4 hours passed from then, the series of the electrical tests was finished.

After stopping the supply of Liq. He, the resistance of field winding No.1

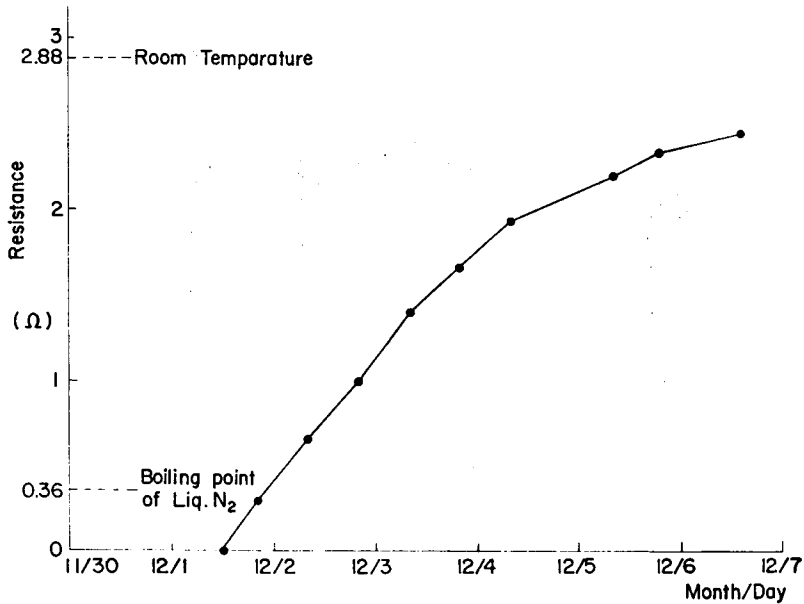

Fig. 13 Resistance of Field Winding after Stopping Supply of Liq. He.

changed as shown in Fig. 13. The temperature of the field winding kept below the boiling point of Liq. N<sub>2</sub> within 24 hours.

5) Quantity of Liq. He consumed.

100 l dewar vessel

- i) The quantity of Liq. He consumed from the beginning of the supply of Liq. He till the beginning of the condensing of Liq. He was 30 l.
- ii) The quantity of Liq. He stored in the cryostat was 34.4 l.
- iii) The quantity of He gas released during the electrical tests was reduced to 19.1 l of Liq. He.

50 l dewar vessel

- i) The quantity of Liq. He stored in the cryostat was 32.5 l.
- ii) The quantity of He gas released during the electrical tests was reduced to 12.1 l of Liq. He.

The amount of Liq. He consumed in the electrical tests was about 5 l per hour.

**4. Electrical Tests**

In the state where the liquid level was kept at the bottom of the No. 3-liquid level gauge, the following electrical tests were performed.

a) Open-circuit test.

An open-circuit test was performed at 1800 r. p. m. of the rotor-speed. The re-

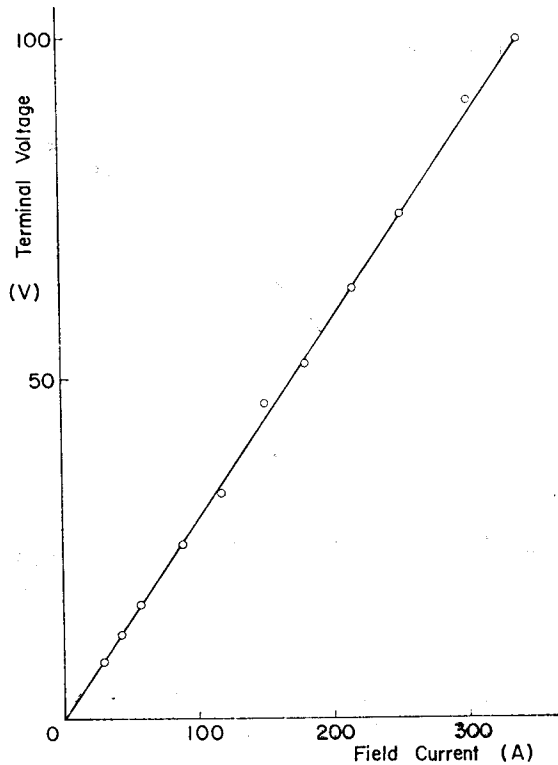

Fig. 14 Open-Circuit Characteristic.

sults of the test are presented in Fig. 14. The relation between the terminal voltage and the field current was linear, as was expected. Fig. 15 illustrates the relation between the flux of the field and field current. The wave-form of the measured terminal voltage with 100 V is sinusoidal as shown in Fig. 16.

In the test, it was found that the more the field current increased, the more the armature current of the motor which drove the generator increased. This is thought to be due to the eddy current of the armature windings in the generator.

b) Three-phase short-circuit test.

A short-circuit test was performed at a rotor speed of 1800 r. p. m. . The result of the test is shown in Fig. 17. The 3-phase currents are balanced. The nonzero armature current for the zero field current may be due to the residual flux of the magnetic shield, that is, out-side part of cryostat.

From the results of a) and b), the synchronous reactance is calculated to be 8.7% p. u. . It is much smaller than that of the conventional synchronous generator.

The small synchronous reactance of the superconducting generator leads to a good network-stability but to a large current at the short-circuit.

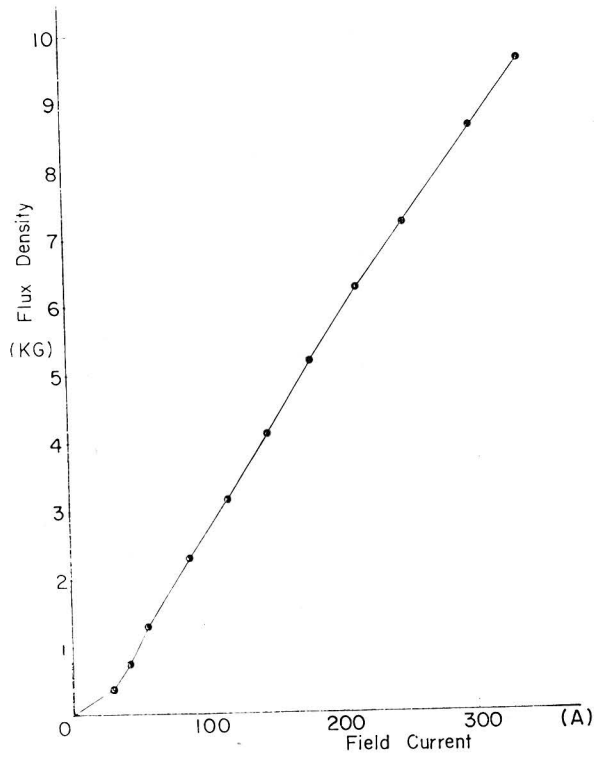

Fig. 15 Flux Density in Field Winding.

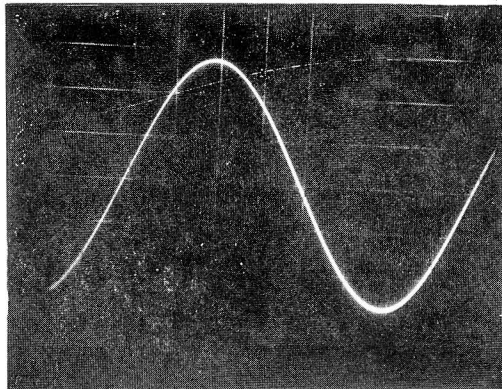

Fig. 16 Wave Form of Terminal Voltage a 100 V.

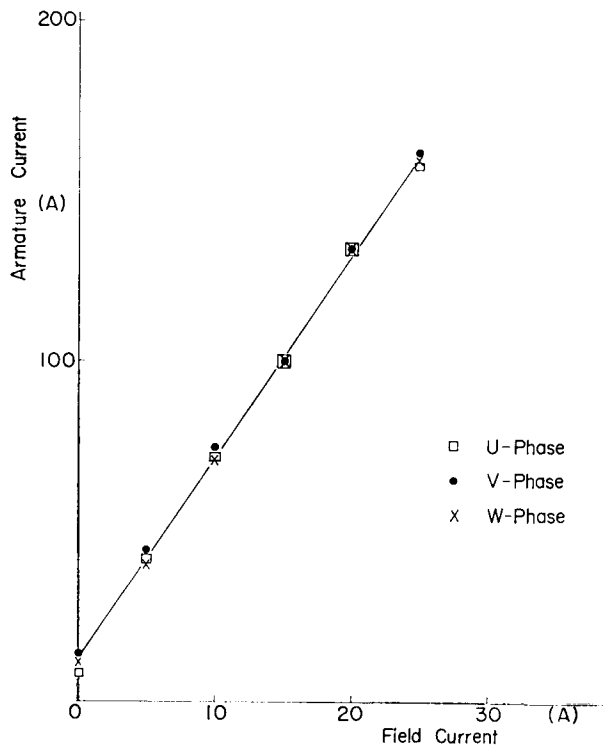

Fig. 17 Short-Circuit Characteristic.

c) Three-phase sudden short-circuit test.

A three-phase sudden short-circuit test at a rotor speed of 1800 r. p. m. and a field current of 10.1 A was initiated. The armature current is shown in Fig. 18. It converged slowly in comparison of that of the conventional synchronous generator.

d) Slip test.

A slip test was performed as follows:

- i) The field winding is open-circuited.
- ii) The rotor is rotated within the limit of slip 1%.
- iii) The armature is connected to a three-phase power source of the rated frequency.

The terminal voltage, the armature current and the field voltage were monitored on an oscillograph. These wave forms, at a rotor speed of 1790 r. p. m. (slip=0.6%), are shown in Fig. 19. From the wave forms, the d- and the q-axes reactances are calculated to be 8.1% p. u. and 6.6% p. u., respectively.

Since the generator has no iron core, the values of the d-axis reactance should be equal to that of the q-axis reactance. It is not understood what the values calcu-

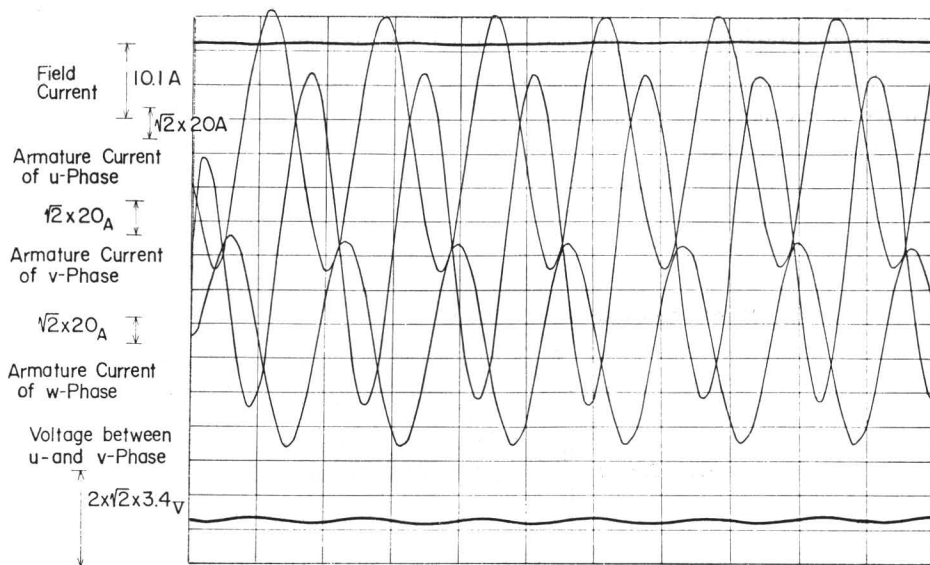

Fig. 18 Three-Phase Sudden-Short-Circuit Characteristic.

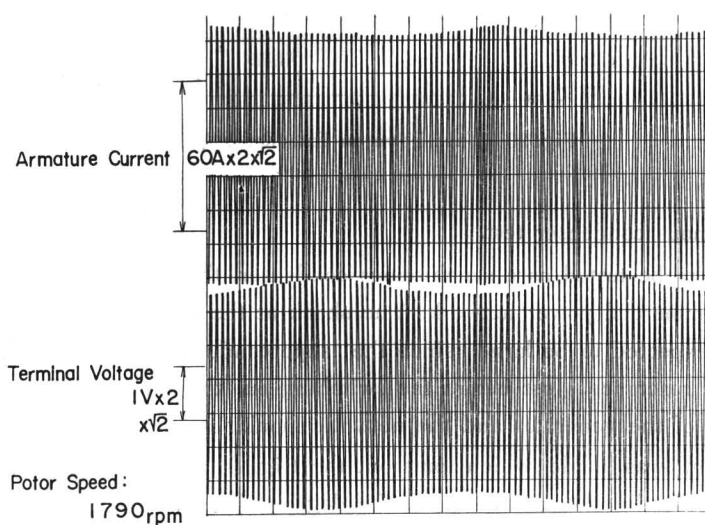

Fig. 19 Wave Form on Slip Test.

lated in this test mean.

e) Extended slip test<sup>3)</sup>.

The values of the d-axis transient reactance can be calculated by an extended slip test. The test is performed by setting the slip 2.5~5%.

The terminal voltages, the armature current and the field voltage were monitored on an oscillograph. These wave forms, at a rotor speed of 1750 r. p. m. (slip=2.8%), are shown in Fig. 20. From the wave forms, the value of the d-axis transient reactance is calculated to be 6.9% p. u. .

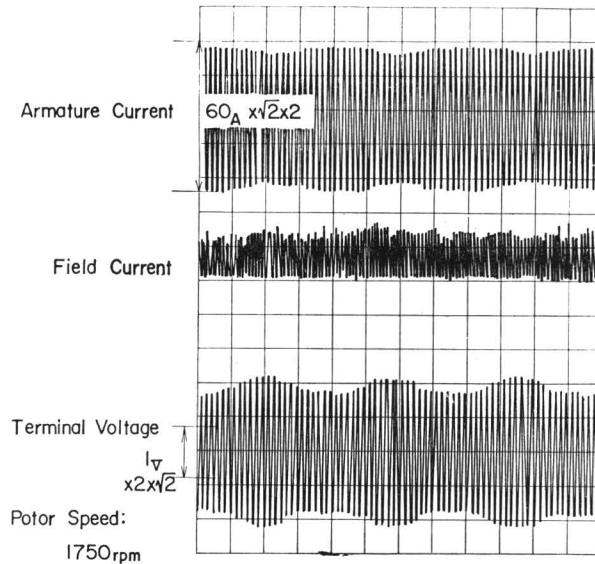

Fig. 20 Wave Form on Extended Slip Test.

f) Synchronous condenser test.

In order to be tested as a synchronous condenser, the generator was placed parallel to a commercial power network. The shock at the switching-on of the parallel running is expected to be large, since the superconducting generator has a small synchronous reactance. Just before the switching-on, the phase difference between the voltages of the generator and the network should be very small.

Equipment was made which puts out the trigger pulse to the circuit-breaker when the phase difference is less than the degree of  $0.5^\circ$ .

By use of the equipment, the switch went on smoothly.

The result of the test is shown in Fig. 21. The V-characteristic, calculated on the condition that the value of the synchronous reactance is 8.7% p. u., is illustrated in Fig. 22.

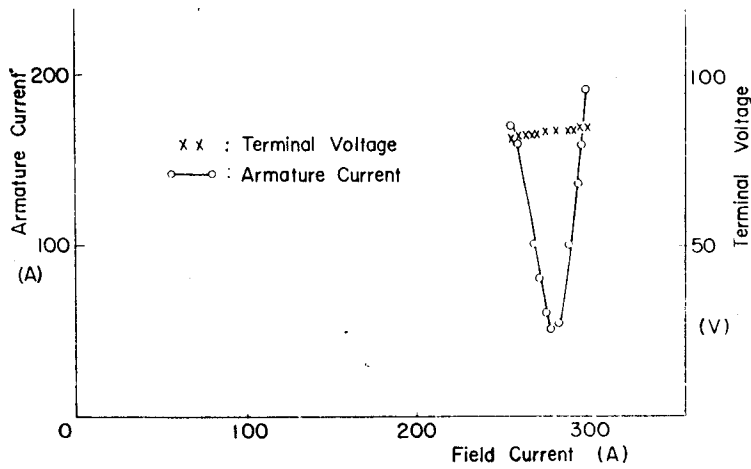

Fig. 21 V-Characteristic measured.

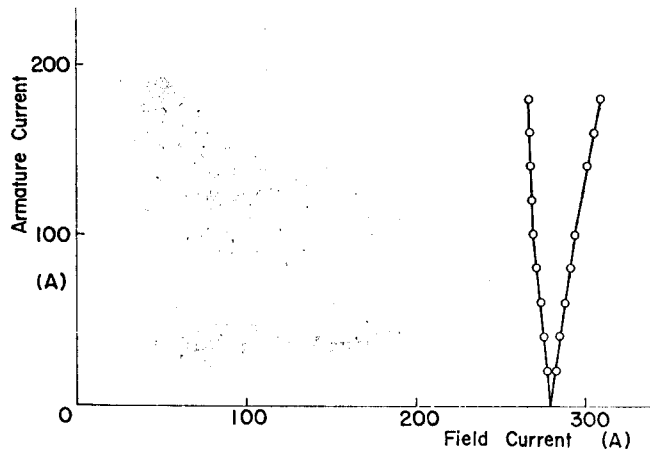

Fig. 22 V-Characteristic calculated.

**Acknowledgements**

The authors would like to express their thanks to Messrs. H. Fujino, A. Ishihara and K. Birei, Fuji Electric Co., Ltd., for their helpful advice on low temperature-techniques.

**Ref.**

- 1) Technical Report of IEEJ. vol. 58 Part II, July, 1977.
- 2) M. Iwamoto, O. Ogino, H. Fujino and A. Ishihara, Convention Records of Cryogenic Association of Japan A-3-1, 1977.
- 3) C. Uenosono, T. Okada and H. Koh, 'The extended slip test for measuring synchronous machine constants', Trans. Elec. Eng. Japan, vol. 97-B, No. 5, 1977.