

Behavior of The Space Charge Produced by The Positive Impulse Corona in Air

By

Osamu YAMAMOTO*, Toshihiko KOUNO*, Chikasa UENOSONO* and
Muneaki HAYASHI*

(Received December 25, 1982)

Abstract

This paper describes the behavior of the space charge produced by the corona by applying the positive lightning impulse voltage to the rod-plane air gap. The relation between the amount of space charge and the injected charge from the rod electrode is discussed here. It was found that the amount of space charge became smaller than the injected charge for the corona highly developed so as to bridge the gap between the electrodes.

1. Introduction

The space charge produced by the corona significantly affects the further development of the discharge. In this study, we measured the space charge by the use of a small metal sphere as a probe. The probe was located far from the corona volume, and was earthed through the resistance. Thus, it could only detect the current caused by electrostatic induction from the space charge without including any true charges from the discharge.

The applied voltage of the testing gap varied from the corona onset voltage up to a 50% flashover voltage in several gap lengths respectively. If the applied voltage is so low that the corona does not bridge the gap, then the amount of space charge is equivalent to the charge injected from the rod into the gap space.¹⁾ However, as the applied voltage increases it is found that the amount of space charge becomes smaller than the injected charge. Therefore, we get a saturated characteristic curve of the space charge with an increase in the injected charge.

Further investigation has been performed to clarify this characteristic by observing the light pulse from the corona volume as well as the currents of the probe and the electrodes simultaneously.

2. Experimental Procedure

The outline of the apparatus used in this study is shown in Fig. 1. In this

* Department of Electrical Engineering

experiment, rod-plane electrodes with a gap length of 5~15 cm were used. The radius of the rod and the plane electrodes were 0.5 cm and 50 cm respectively. The rod had a hemisphere on its tip, and was insulated from the cylindrical part for measuring the charge injected into the gap space by the corona discharge. The voltage which had a wave form of $+(1.8/50)\mu s$ was applied to the rod, changing its peak value from the corona onset voltage (V_{on}) up to the 50% flashover voltage

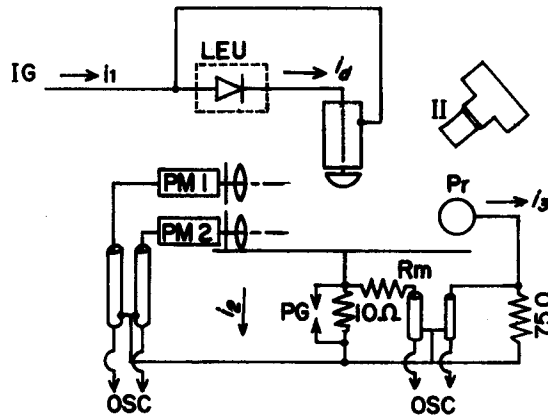

Pr; Probe, PM_{1,2}; Photomultipliers, II; Still camera with image Intensifier, LEU; Light Emission Unit, PG; Protection gap, Rm; Resistance for impedance matching, IG; Impulse voltage generator.

Fig. 1. Experimental set up.

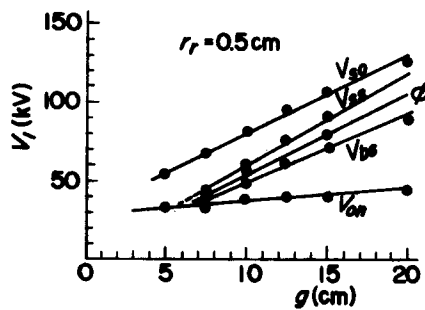

V_{50} ; 50% flashover voltage, V_{SS} ; onset voltage of the corona (SS), V_{PS} ; minimum voltage for the corona (PS) to bridge across the gap, V_{on} ; corona onset voltage.

Fig. 2. Relations among 5 characteristic voltages and the gap lengths.

(V_{50}) in each gap length. The relations between V_{on} , V_{50} and the gap length g are shown in Fig. 2. Also shown is the relation between the voltage V_{bs} , at which the corona bridges the whole gap, and the gap length.

The probe for measuring the space charge had a radius of 0.5 cm, and was located at a distance of 1.5 times and 0.5 times the gap length measured from the gap axis and the plane, respectively. The probe was earthed through the resistance (75Ω) as shown in Fig. 1. The details concerning this method have been described in a previous paper.¹⁾ The amount of the space charge Q_s was evaluated from the knowledge of the induced charge q_s on the probe using the following equation:

$$Q_s = Aq_s = -A \int_{t_0}^{t_0+\tau} i_s dt, \quad (1)$$

provided that the corona develops during the period of time $t = t_0 \sim t_0 + \tau$, and that i_s is the induced current on the probe. A is a coefficient of proportionality between q_s and Q_s , and it varies according to the gap length. This coefficient has been found experimentally to be -30 , -66 , -110 and -180 for the gap length of 5, 7.5, 10 and 15(cm) respectively.¹⁾

The amount of the injected charge from the semisphere at the tip of the rod was obtained using the following equation:

$$Q_d = \int_{t_0}^{t_0+\tau} i_d dt, \quad (2)$$

where i_d is the current flowing from the semisphere to the gap space during the corona growth. This current was measured by the use of a "Light Emission Unit" as shown in Fig. 1. This unit consisted of a light emission diode, a light guide cable and a photomultiplier.

For analyzing the development of the corona and its relation to the generation of the space charge, two photomultipliers were employed. Each of them had a quartz lens and a slit arranged perpendicular to the gap axis. One photomultiplier was fixed to see the light near the rod tip, and the other was arranged to see the optional position along the gap axis. The signal of the former photomultiplier was used to trigger the oscilloscope for observing the latter photomultiplier and the currents. The shape of the corona was also observed by the use of a still camera with an image intensifier in front of the camera.

3. Experimental Results

3.1 Relations of Q_s , Q_d , vs. the applied voltage

Fig. 3(a) shows the relation between Q_s and the applied voltage V_1 with the gap length as the parameter. These data are for the corona which develops during

about 3 ms after the crest of the applied voltage has been formed. With reference to Fig. 3(a), Q_s increases exponentially as V_1 increases. However, the rate of increase decreases with voltage higher than the certain value ϕ , except in the case of $g=5$ cm. The relation of ϕ to g has been presented in Fig. 2, and it is seen that ϕ is a little higher than the corona onset voltage. In the case of $g=5$ cm, ϕ is very close to the corona onset voltage, so that this might be the reason why the rate of increase

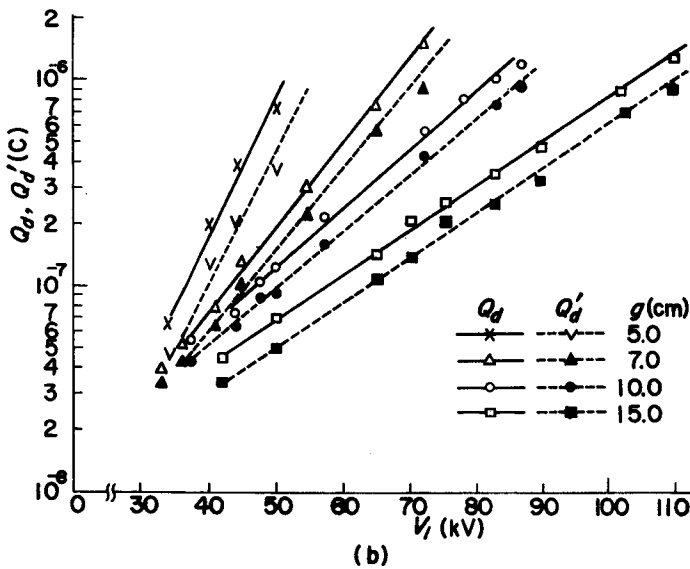
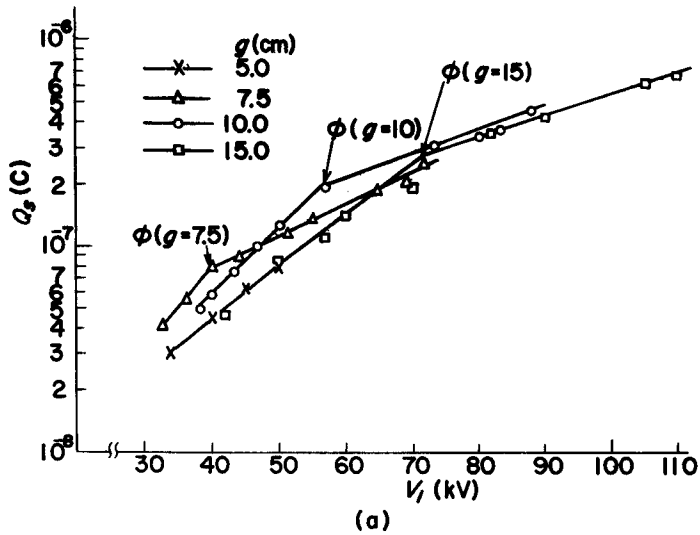

Fig. 3. Relations of Q_s , Q_d vs. V_1 .

Table 1. The coefficients $w_1 \sim w_4$ used in the empirical formulas

g (cm)	$w_1 (\times 10^{-9})$		$w_2 (\times 10^{-3})$		$w_3 (\times 10^{-9})$	$w_4 (\times 10^{-3})$
	$V_{0n} \leq V_1 \leq \phi$	$V_1 > \phi$	$V_{0n} \leq V_1 \leq \phi$	$V_1 > \phi$	$V_1 \geq V_{0n}$	$V_1 \geq V_{0n}$
5		3.7		0.060	0.4	0.150
7.5	2.2	14.5	0.090	0.040	2.2	0.090
10	4.9	31.0	0.064	0.030	4.7	0.065
15	3.7	66.0	0.060	0.023	3.6	0.060

does not change any more.

The relation between Q_s and V_1 can be expressed empirically as follows:

$$Q_s = w_1 \exp. (w_2 V_1) \tag{3}$$

In Eq. 3, w_1 is the intersection of the Q_s -axis, and w_2 is the rate of increase. The values of w_1 and w_2 are shown in Table 1.

Fig. 3(b) shows the relation between Q_d and V_1 with g as the parameter. Also shown is the relation between the charge Q_d' and V_1 for reference, where Q_d' is the amount of charge flowing from the plane to earth during the corona growth ($Q_d' = \int_{t_0}^{t_0+\tau} i_2 dt$, where i_2 is the current of the plane). (See Fig. 1.) With reference to Fig. 3(b), Q_d also increases exponentially with an increase in V_1 . However, the rate of increase does not change as in the case of Q_s . Q_d' runs parallel to Q_d , but it has a slightly smaller value compared with Q_d .

Thus, we can express the relationship between Q_d and V_1 as follows:

$$Q_d = w_3 \exp. (w_4 V_1) \tag{4}$$

The values of w_3 and w_4 are shown in Table 1 for each gap length.

3.2 Relation of Q_s vs. Q_d

As mentioned in a previous paper, Q_s is coincident with Q_d so far as the corona ceased its development before reaching the plane electrode. That is, $Q_s = Q_d$ for an applied voltage lower than V_{bs} . However, this relationship seems to be applicable for a corona developed under the condition that $V_{0n} \leq V_1 \leq \phi$. This is because w_1 and w_2 are almost equal to w_3 and w_4 respectively, according to Table 1 under that condition. On the other hand, Eqs. 3 and 4 give the following relationship for a corona developed under the condition that $V_1 > \phi$.

$$Q_s = w_1 (Q_d/w_3)^{w_2/w_4} \tag{5}$$

The relation of Q_s to Q_d is shown in Fig. 4, where the drawn curves are the results calculated by using Eq. 5. From Fig. 4, it is obvious that the curves deviate from the line representing $Q_s = Q_d$, and that Q_s becomes smaller as Q_d increases beyond

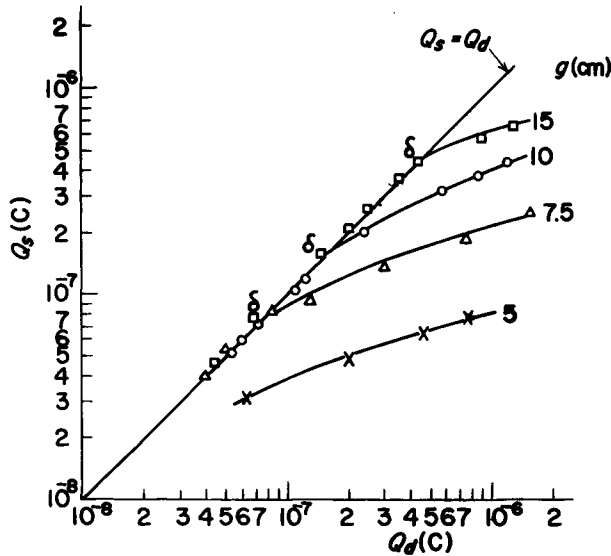

Fig. 4. Relations of Q_s , Q_d vs. applied voltage V_1 .

the certain value δ in each gap length. Hence, we get the saturated characteristics of the space charge by increasing the injected charge.

4. Generation of the Space Charge

The probe current i_3 is induced and flows toward earth in accordance with the generation of the space charge in the testing gap. In this section, the generation of the space charge is discussed with the knowledge of the probe current and the light pulses.

Two examples of this measurement are shown in Fig. 5, where the gap length is arranged to be 10 cm. Fig. 5(a) is the example where the applied voltage V_1 is lower than V_{bs} , so that the corona does not bridge the gap. With reference to the oscillograph of the light pulses, the corona (Primary streamer, PS) develops from the rod tip ($z=10$ cm) at a time $t=t_0$ and arrives above the plane ($z \approx 2.5$ cm) at $t=t_0+350$ ns. On the other hand, the current i_3 and the currents i_d , i_2 , measured simultaneously by using two oscilloscopes, rise up at $t=t_0$ and after forming each peak, they reduce to zero at $t=t_0+350$ ns, in accordance with the extinction of PS. Moreover, these currents form an almost similar figure with each other. From the fact that the duration of i_3 is coincident with that of the corona development, the space charge is confirmed to be generated just during the corona growth. In this case, the amount of space charge Q_s is evaluated to be 7.9×10^{-7} C, and the injected charge Q_d from the semisphere to be 7.5×10^{-7} C, using Eqs. 1 and 2 respectively.

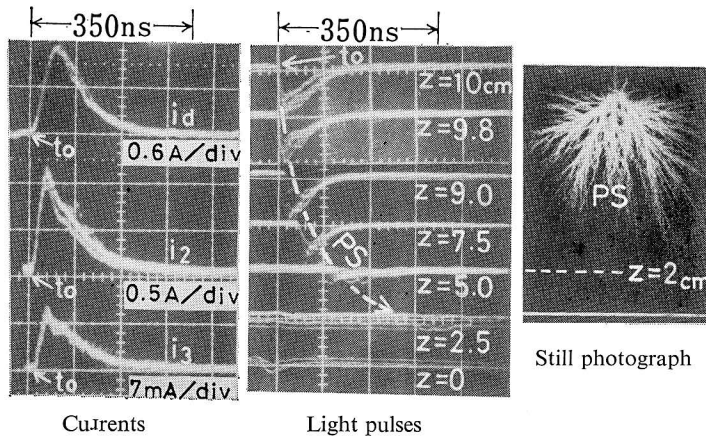

(a) $V_1=44\text{kV}$ ($V_1 < \phi$, 100ns/div V)

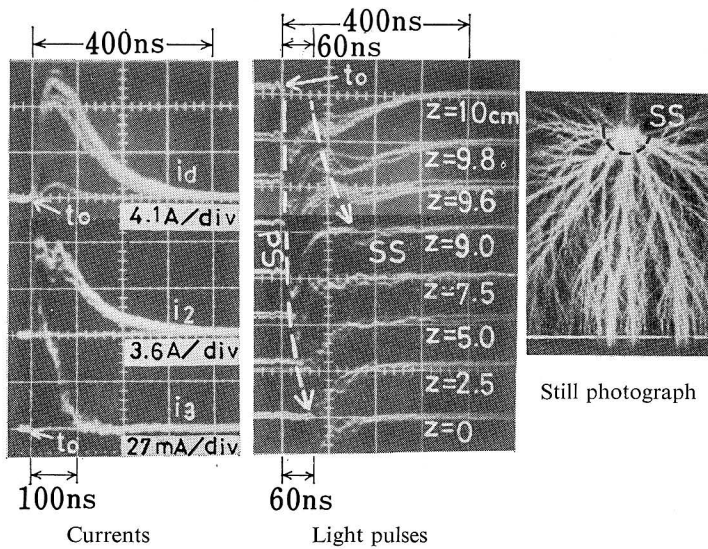

(b) $V_1=83\text{kV}$ ($V_1 > \phi$, 100ns/div)

Fig. 5. Oscillograms of currents, light pulses and the photographs of the coronas. ($g=10\text{ cm}$)

Hence, we get the relation that $Q_s \approx Q_d$, as mentioned earlier.

The other example is shown in Fig. 5(b), where V_1 is arranged to be near V_{50} . This voltage is high enough to cause the corona to bridge the gap. The corona under such a condition is maintained not only by PS but also by a close succession of a secondary streamer (SS) as is shown in the figure. In this case, PS reaches the plane at $t=t_0+60\text{ ns}$, then SS propagates about 1 cm in its length from the rod tip

toward the plane. The duration of the light pulses near the rod tip are about 400 ns, including both streamers, and the light pulses reduce to zero at $t \simeq t_0 + 400$ ns.

With reference to the current oscillograph, i_d and i_s flow during the same period as that of the light pulses mentioned above, forming almost a similar shape with each other. On the other hand, i_s reduces faster in comparison with the other two currents, and diminishes to zero at $t \simeq t_0 + 100$ ns. Therefore, the duration of i_s is rather longer than the period of PS propagation, but is about 300 ns shorter than that of i_d and i_s . Thus, it is found that the space charge is mainly generated by PS and that there is little generation by SS. In this case, Q_s is estimated to be 3.5×10^{-7} C and Q_d to be 1×10^{-6} C. Consequently, we get the relation that $Q_s < Q_d$.

From these experimental results, we can bring the difference between Q_s and Q_d into relation with SS. As a matter of fact, SS can be observed for an applied voltage slightly higher than ϕ , at which voltage Q_s becomes smaller than Q_d in each gap length. However, further investigation is necessary to clarify the reason why only a little space charge is generated during the growth of SS. The results concerning this investigation will be presented in the next paper.

5. Conclusion

An investigation using a small metal sphere as a probe has revealed that there is a period during the corona growth when the corona produces little space charge. Because of this phenomenon, the amount of space charge does not increase as much as does the injected charge from the rod electrode with an increase in the applied voltage. This behavior of the space charge is considered to be very important for further study on the development of the discharge under the non-uniform electric field in air.

Reference

- 1) O. Yamamoto et al.; "Space Charge Measurement Using a Small Sphere as a Probe". *Memoirs of the Faculty of Engineering, Kyoto University*, Vol. XLIV, Part 4 (1982) 483.