

Water reuse and recycling in Japan — History, current situation, and future perspectives

Haruka Takeuchi^{*}, Hiroaki Tanaka

Research Center for Environmental Quality Management, Kyoto University, Shiga, 520-0811, Japan

ARTICLE INFO

Keywords:

Water reuse
Japan
Implementation examples
Demonstration project
Membranes
UV
Virus removal
Public acceptance
Promising technologies

ABSTRACT

Water reuse is an effective option all over the world for saving water resources, reducing environmental impacts, and reducing the costs and energy involved in water resource management. In Japan, non-potable water reuse has been implemented in several cities since the 1980s, mainly for urban applications such as toilet flushing, urban stream water augmentation, and landscape irrigation. However, utilization of reclaimed water is still limited in Japan due to the inadequate quality standards for reclaimed water and the high energy consumption of water reclamation facilities. From 2010 to 2015, a Core Research for Evolutional Science and Technology (CREST) project was carried out in Japan to develop energy-efficient water reclamation processes utilizing membrane technologies and ozonation processes. A comprehensive evaluation of the process performances and the economic feasibility showed that the UF + UV (ultrafiltration + ultraviolet radiation) process provided removal of viruses to a level adequate for water reuse for agricultural purposes at low cost. Based on the results from the CREST project, a demonstration plant incorporating the UF + UV process was constructed at the Itoman wastewater treatment plant in Okinawa to evaluate performance in terms of virus removal and to implement agricultural water reuse. Other innovative technologies are also under development in Japan to reduce the cost and energy involved in water reclamation. This paper introduces the history, current situation, and future perspectives of water reclamation and reuse in Japan.

1. Introduction

Water reuse can be an effective option all over the world for saving water resources, reducing the environmental impacts from the discharge of treated wastewater, and reducing the cost and energy involved in water resource management [1]. Because of these advantages, potable and non-potable water reuse has been implemented around the world [2].

Japan has a wet and mild climate and its average annual precipitation is 1,718 mm, which is about twice the world average (810 mm) [3]. Thus, it can be argued that Japan is a low water stress country and that water scarcity is not a strong driver for water reuse. However, because of seasonal variations in rainfall and because of the small land area, which means that rivers flow rapidly to the oceans, the amount of water resources per capita in Japan (about 3,300 m³/year) is less than half the world average (about 7,800 m³/year) [3]. This low availability of fresh water made for difficult challenges in water resource management, especially in large urban areas which were experiencing rapid economic growth and population concentrations during the period from the late

1950s and the early 1970s. In addition, severe droughts stressed the reliability of water supply systems. To overcome these situations, water reclamation and reuse started to be implemented in major urban areas [4, 5]. For example, Fukuoka city, which experienced serious drought in 1978, started to use reclaimed water for urban applications such as toilet flushing. Tokyo also started to implement water reuse in response to urban redevelopment. Water reclamation and reuse systems implemented on a block-wide scale or onsite in individual buildings provided reclaimed water for toilet flushing and landscape irrigation.

In addition to water scarcity, environment protection is a major driver for water reuse in Japan. Stream flow augmentation in urban areas began to attract attention in Japan in the 1980s when the water flow of urban streams decreased dramatically as a consequence of urbanization. The Tokyo metropolitan government was the first in Japan to use reclaimed water to replenish dry streams to restore stream flow and the aquatic environment. In response to the successful implementation in Tokyo, stream flow augmentation with reclaimed water spread to many regions in Japan. Currently, stream flow augmentation is the most common application of reclaimed water in Japan.

^{*} Corresponding author.

E-mail address: takeuchi.haruka.6m@kyoto-u.ac.jp (H. Takeuchi).

<https://doi.org/10.1016/j.watcyc.2020.05.001>

Received 1 April 2020; Received in revised form 7 May 2020; Accepted 10 May 2020

Available online 15 June 2020

2666-4453/© 2020 The Authors. Publishing Services by Elsevier B.V. on behalf of KeAi Communications Co. Ltd. This is an open access article under the CC BY-NC-ND

license (<http://creativecommons.org/licenses/by-nc-nd/4.0/>).

Another possible driver for water reuse in Japan is as a measure against natural disasters. With the increasing frequency of natural disasters such as earthquakes, water supply restrictions now occur more often. When the Great East Japan Earthquake struck in 2011, many water and wastewater treatment plants were severely damaged and water supplies were restricted. Water reuse systems, in particular onsite systems, can be attractive solutions for such emergency situations.

In order to emphasize the importance of water reuse and to promote its implementation, the Japanese government established important laws in 2014 and 2015. “The Basic Act on the Water Cycle”, enacted in 2014, was the first law in Japan to emphasize the importance of water reuse in water resource management. The Japanese government also established its “New Sewage Vision” in 2014 outlining its action plan for water reuse by doubling the number of water reclamation facilities in cities with a population of >100,000. In 2015, the “Water Resources Policy” was established, also to promote water reuse.

However, until now, utilization of reclaimed water has been somewhat limited in Japan due to two possible reasons: 1) the lack of sufficiently stringent quality standards for reclaimed water in terms of chemical/pathogen risk and 2) the high energy consumption of water reclamation facilities. Even though quality guidelines for reclaimed water were established in Japan in 2005, the regulations cover only *E. coli*, total coliforms, turbidity, pH, appearance, color, odor, and residual chlorine. To guarantee the quality of reclaimed water and obtain greater public acceptance, it is important to establish quality standards that also cover contaminants such as chemicals and viruses. On the other hand, water quality improvement, in general, involves a trade-off with cost reduction in water reclamation facilities. Therefore, it is necessary to propose and develop appropriate water reclamation processes according to the intended applications of the reclaimed water.

A Core Research for Evolutional Science and Technology (CREST) project was carried out in Japan during 2010–2015 to develop revolutionary water reuse technologies. This research program aimed to develop energy-efficient water reclamation processes by focusing on membrane technologies and ozonation. The performance and the economic feasibility of each process were comprehensively assessed by 1) evaluating the removal performances for contaminants, in particular viruses, 2) conducting risk assessment for several scenarios, and 3) calculating energy consumption. One highly important outcome from this research program was the development of an ultrafiltration plus ultraviolet radiation (UF + UV) process for treating water for agricultural reuse. This process can provide >5.2-log removal of viruses at a pilot-plant scale with lower cost and lower energy consumption than the process stipulated in the California Title 22 regulations for reclaimed wastewater [6].

Based on the results from the CREST project, a feasibility study was conducted in the Breakthrough by Dynamic Approach in Sewage High Technology (B-DASH) project during 2015–2017. In that project, a demonstration plant with the UF + UV process was constructed at the Itoman wastewater treatment plant (WWTP) in Okinawa to evaluate the removal performance for viruses. Since breakage of the hollow-fiber UF membrane might cause a decrease in virus reduction and a deterioration in the reclaimed water quality, the effect of UF membrane breakage on virus removal was assessed at pilot scale. The reclaimed water from the demonstration plant was supplied to an agricultural area near the plant and the vegetables irrigated with this water were sold at a local supermarket. Questionnaire surveys were conducted to investigate the public acceptance of the reclaimed water and the vegetables grown with it, the results of which highlighted the importance of public education and outreach activities. Prompted by this successful water reuse for agricultural applications, a project for the reuse of reclaimed water for industrial applications is now in the planning stage in Okinawa.

In addition to these pilot-scale and full-scale water reuse projects, laboratory-scale studies have been conducted in Japan to develop innovative and more energy-efficient water reclamation processes. This paper introduces the history, current situation, and future perspectives of water

reuse in Japan.

2. History of water reuse in Japan

Water reuse history in Japan started in the 1980s in response to severe drought and increased water demand caused by rapid urbanization and economic growth. Since then, non-potable reuse, in particular urban water reuse, has been gradually implemented in Japan (Table 1). The history of water reuse is divided into three phases. In the first phase, water reuse for toilet flushing started in urban areas. Then, stream flow augmentation started in the late 1980s as the second phase. In the third phase, multipurpose applications including for heat transfer and emergency applications have been developed.

2.1. Phase 1: Toilet flushing and landscape irrigation

The first regional water reuse scheme was implemented in Fukuoka City which experienced serious drought in 1978. Water supply was restricted for 287 days during the drought. To address this issue, the Fukuoka city government started to establish a “water conservation-conscious city” with its citizens by promoting the installation of water recycling facilities to treat wastewater for flushing toilets and for landscape irrigation [7]. The first water reclamation facility was installed in 1980 in the Chubu wastewater treatment plant which is located near the city center. At that time, the water reclamation facility had a capacity of 400 m³/day and treated secondary effluent by sand filtration, ozonation, and chlorination. A dual distribution system was employed and reclaimed water was distributed separately from tap water and was distinguished with yellow pipelines. Reclaimed water was supplied to 12 public facilities such as the city hall and the central police station for toilet flushing.

The city government effectively enhanced the water reclamation facility to meet the demand from the users of reclaimed water: the capacity was gradually expanded in response to the increasing demand for reclaimed water (Fig. 1), and the quality of the reclaimed water was improved in steps by integrating coagulation, sand filtration, pre-filtration, ozonation, and chlorination processes. The reclaimed water supply was extended to large buildings in the city center in 1989, and to the commercial area in 1995. In response to another serious drought in 1994, a second water reclamation facility was newly constructed in 2003 in the Tobu wastewater treatment plant. The city government issued an ordinance in 2003 requiring building owners to install water reclamation facilities. The water reuse project was managed by a national subsidy and reclaimed water rates from reclaimed water users.

Tokyo also started a water reuse project in the 1980s in the west Shinjuku district where a huge urban redevelopment project had been launched [4]. To promote water reuse and save on investment in large-scale water and wastewater infrastructures, many new buildings were requested to install water recycling facilities such as dual distribution systems for water supply. Reclaimed water sent from the Ochiai wastewater treatment plant was used for toilet flushing and green belt irrigation (Fig. 2). The Tokyo Metropolitan Government vigorously promoted water reclamation and reuse.

To promote water reuse on a regional scale, the Fukuoka city government and Tokyo metropolitan government required the use of reclaimed water or rainwater for toilet flushing and green belt irrigation in buildings with floor space exceeding 5,000 m² (Fukuoka) or 10,000 m² (Tokyo). As a result, water reuse on a regional scale was implemented in Tokyo in the Shinjuku, Shinagawa, and Tokyo Bay areas. However, water reuse on a regional scale was limited to these three areas. Since building owners in other areas in Tokyo could not access the regional water reuse schemes, they needed to install individual recycling systems or rainwater harvesting systems utilizing graywater and/or rainwater (Fig. 3). The capital expenditure and operational expenditure of small-sized facilities were a financial burden on the building owners. Therefore, water reuse facilities are limited in number and rainwater harvesting systems are

Table 1
Representative water reuse facilities in Japan.

| Starting date | City | WWTP | Capacity [m ³ /day] ^a | Process ^a | Application |
|---------------|----------|-----------------|---|--|--|
| 1980 | Fukuoka | Chubu | 10,000 | Coagulation/O ₃ / Fiber filtration | Toilet flushing, Irrigation |
| 1984 | Tokyo | Ochiai | 8,000 | Sand filtration | Toilet flushing |
| 1984 | Tokyo | Tamagawa Johryu | N.A. | Sand filtration/O ₃ | Stream flow augmentation |
| 1988 | Chiba | Hanamigawa | 4,120 | Sand filtration/O ₃ | Toilet flushing |
| 1993 | Tokyo | Ochiai | 8,000 | MF/RO | Recreational |
| 1995 | Osaka | Nagisa | 8,100 | Sand filtration | Toilet flushing |
| 1996 | Tokyo | Ariake | 30,000 | Biofiltration/O ₃ | Toilet flushing |
| 1997 | Yokohama | Minatokita | 32,000 | Sand filtration/O ₃ | Toilet flushing |
| 1997 | Tokyo | Shibaura | 5,000 | Sand filtration/O ₃ | Toilet flushing, Train washing |
| 1998 | Hyogo | Awaji | 22,00 | Sand filtration/O ₃ | Toilet flushing |
| 1998 | Tokyo | Shibaura | 7,000 | Ceramic filtration/O ₃ | Toilet flushing |
| 2000 | Saitama | Saitama | 8,000 | Biofiltration/O ₃ | Toilet flushing, Fire extinguishing, Landscape irrigation |
| 2001 | Kagawa | Tobu | 1,400 | Biofiltration/O ₃ | Toilet flushing |
| 2002 | Tokyo | Shibaura | 6,700 | Sand filtration/O ₃ | Toilet flushing |
| 2003 | Fukuoka | Tobu | 1,600 | Coagulation/O ₃ / Fiber filtration | Toilet flushing, Landscape irrigation |
| 2007 | Chiba | Hanamigawa | 0.259 m ³ /sec | Coagulation/Sand filtration/O ₃ | Stream flow augmentation |
| 2012 | Chiba | Hanamigawa | 200,000 | — ^b | District heating and cooling |
| 2013 | Osaka | Sampo | 34,000 | Fiber filtration/O ₃ | Toilet flushing, Landscape irrigation, Recreational, Cooling water |

WWTP: wastewater treatment plant.

N.A.: no data available.

MF: microfiltration process.

RO: reverse osmosis membrane process.

^a Capacity and treatment processes have been upgraded since the starting date and the current ones are shown.

^b No advanced treatment was applied and disinfected secondary effluent was used directly.

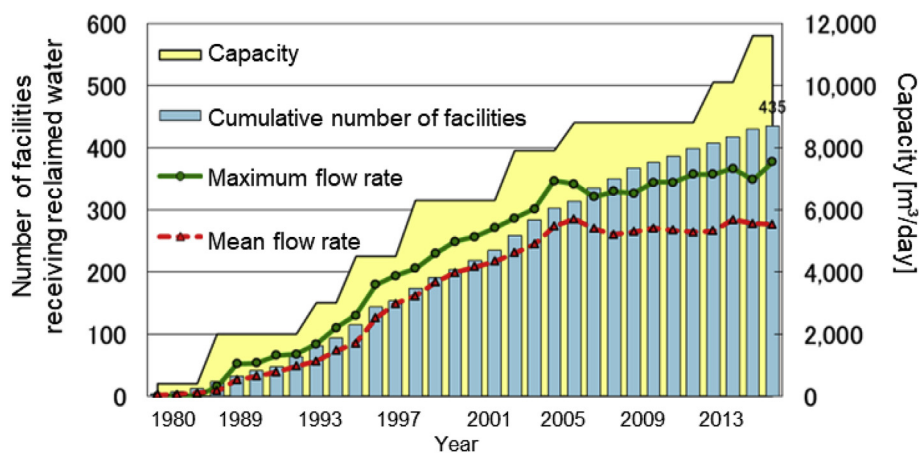

Fig. 1. The development of water reclamation facilities in Fukuoka City [8].

more developed, but these appear to be not so reliable and rainwater users will probably need to rely on the public water supply in a serious drought.

2.2. Phase 2: Stream flow augmentation and recreational applications

In the mid-1980s, stream flow augmentation in urban areas began to attract attention. As a consequence of urbanization and the increased water intake, the water flow of urban streams had decreased dramatically in Tokyo. To accommodate the demand from the citizens for the revival of stream flows, the Tokyo metropolitan government started to use reclaimed water as an alternative source of water for dried-up streams. During the period from 1984 to 1989, stream flow augmentation was implemented in three irrigation channels in Tokyo by discharging reclaimed water from the Tamagawa-Jouryu WWTP, which treated

secondary effluent by sand filtration and ozonation. In 1995, reclaimed water treated by sand filtration in the Ochiai WWTP also started to be discharged into three urban rivers. These water reuse projects successfully recovered the water flow in the dried-up streams to the extent that sweetfish now inhabit the rivers and citizens enjoy the water environment.

2.3. Phase 3: Multipurpose applications

In the third phase, water reuse was implemented for multipurpose uses and emergency water resources of towns. Heat in reclaimed water has attracted attention because of its potential contribution to a low-carbon society. Because sewage temperature is more stable than atmospheric temperature, the efficiency of heat pump systems is improved when reclaimed water is used for the heat source/heat sink. Recently the

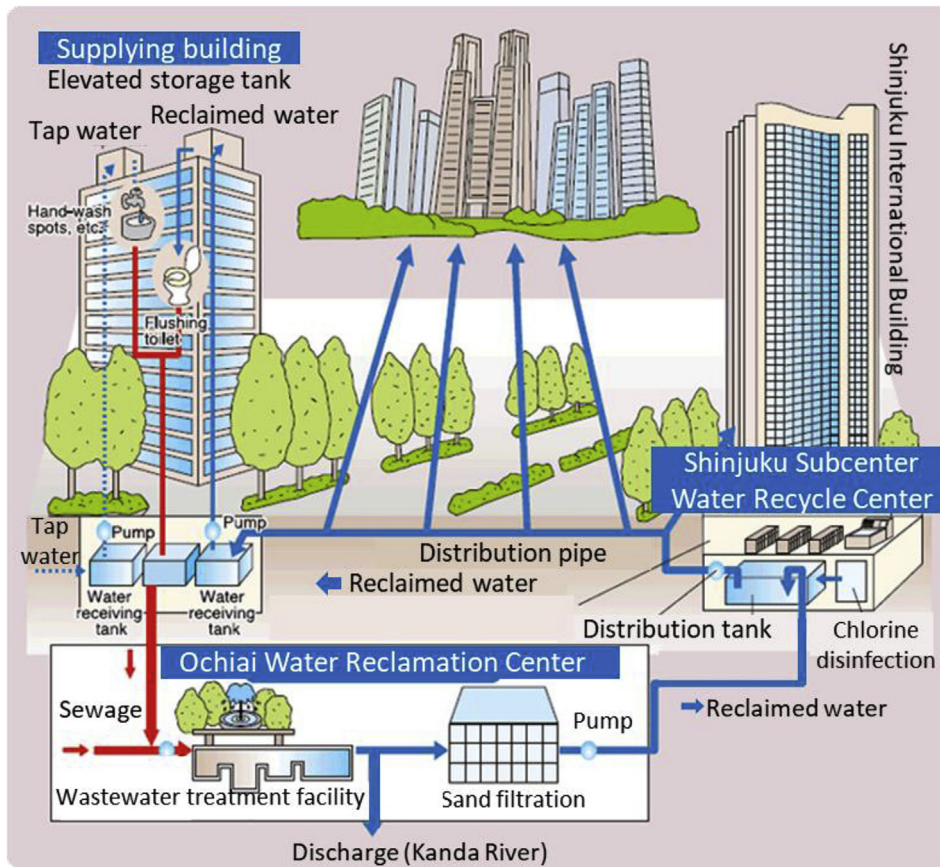

Fig. 2. Water reuse system in the west Shinjuku district, Tokyo [9].

Reuse style in 23 Wards of Tokyo



Fig. 3. The number of installation facilities in Tokyo. TMG: Tokyo metropolitan government.

number of WWTPs with reclaimed water supply standpipes for filling water tank lorries has been increasing. In drought events, reclaimed water is used for road cleaning and green belt irrigation in most cases. In Japan, in addition to urban applications, reclaimed water is used for various purposes such as industrial water and agricultural water.

2.4. Challenges of water reuse in Japan

Although water reuse has been developed in Japan since the 1980s, the utilization of reclaimed water is still limited. The amount of reclaimed water consumed outside of WWTPs was 210 million m³/year

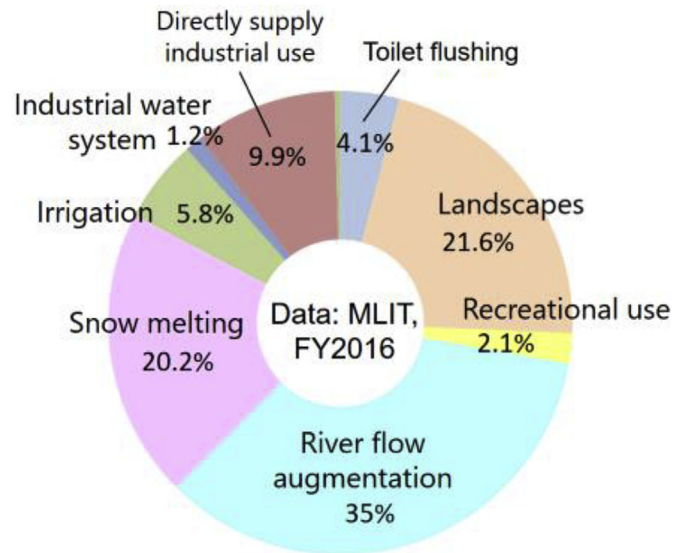

Fig. 4. Applications of water reuse in Japan [10].

in 2016, which was only 1.3% of the total amount of wastewater produced (i.e. 14.7 billion m³/year) [10]. Furthermore, there were only 176 WWTPs with water reclamation facilities, which is only 8% of the total WWTPs in Japan. The most common application of reclaimed water in Japan is stream flow augmentation (35%), followed by landscape irrigation (21.6%), and snow melting water (20.2%) (Fig. 4). A small amount of reclaimed water is used for agriculture irrigation (5.8%), toilet flushing (4.1%), recreational applications (2.1%), and industrial activities (1.2%). The Japanese government recommends that municipalities

double the number of facilities supplying reclaimed water.

There are two possible reasons for the limited utilization of reclaimed water in Japan. The first possible barrier is the lack of sufficiently comprehensive quality standards for reclaimed water, which leads to public concern about reclaimed water. In 2005, quality standards for reclaimed water were established in Japan to regulate the levels of *E. coli*, total coliforms, turbidity, pH, appearance, color, odor, and residual chlorine (Table 2) [11]. However, this quality standard does not regulate any chemicals and viruses so that the safety of reclaimed water with respect to these contaminants is not guaranteed.

Another barrier against promoting water reuse in Japan is the low economic competitiveness of reclaimed water compared to the conventional water supply such as drinking water. Although some water reclamation facilities have a unit energy consumption similar to that of the drinking water supply facilities, most water reclamation facilities consume more energy than drinking water supply facilities. To promote water reuse in Japan, it is necessary to supply reclaimed water that is safe and to lower the cost/energy consumption of water reclamation facilities.

2.5. Risk and energy management of water reuse

From 2010 to 2015, a JST CREST research project was conducted in Japan to develop water reclamation processes appropriate to the application of the reclaimed water. This research program aimed to develop energy-efficient water reclamation processes by focusing on membrane technologies and ozonation processes. The water reclamation processes evaluated included coagulation + UF, UF + UV, UV + nanofiltration (NF), UV + reverse osmosis (RO), and ceramic MF + ozonation. The process performances and economic feasibilities were comprehensively assessed by 1) evaluating the removal performances for contaminants, in particular viruses, 2) conducting risk assessment for several scenarios, and 3) calculating energy consumption.

Public health and environmental risk should be reduced to below the acceptable/tolerable level. Two aspects are necessary to consider with water reuse: hazardous chemicals and pathogens. With respect to human health, pathogens are quite important in both potable and non-potable water reuse applications owing to their high infectivity. On the other hand, chemical risk is less important with respect to human health in the case of non-potable water reuse because most hazardous chemicals involve chronic toxicity, and the exposure frequency and the concentrations of such chemicals in non-potable water are much lower than with potable reuse. In the case of non-potable water reuse, the risks of chemicals to ecosystems, rather than human health, should be the focus of attention.

In the CREST project, chemical risk to aquatic ecosystems was assessed based on the hazard quotient, which is the ratio of the predicted

environmental concentration (PEC) and the predicted no effect concentration (PNEC). If the hazard quotient is calculated to be less than 1, no adverse health effects are expected as a result of exposure. If the hazard quotient is higher than 1, adverse health effects are possible. Hazardous chemical concentrations in sewage were estimated from chemicals discharged to public sewers as reported in the national Pollutant Release and Transfer Register (PRTR). Then, these estimated values were compared with drinking water standards for human health and with the PNECs estimated from an ecological toxicity database (ECOTOX of the United States Environmental Protection Agency [USEPA]). As a result, a few chemicals were calculated to have hazard quotients of over 1, and more than 10 chemicals including surfactants, metals, and pharmaceuticals were estimated to pose risks to aquatic ecosystems. These results suggest that ecosystems are more susceptible than humans to hazardous chemicals and that attention needs to be paid to ecological protection when reclaimed water is used for river flow augmentation.

In order to estimate the risks from pathogens, in particular viruses, quantitative microbial risk assessment (QMRA) was conducted. If the annual acceptable or tolerable risk level is determined, the necessary reduction in level of pathogens during water reclamation can be estimated. As for risk management, the USEPA assumes 10^{-4} (1 infection per 10,000 exposed consumers/year) is acceptable risk for drinking water, while the World Health Organization (WHO) assumes 10^{-6} disability-adjusted life year (DALY) per person per year is tolerable for drinking water and water reuse [12]. The necessary level of virus reduction in the water reclamation process after secondary effluent was estimated to satisfy the WHO tolerable risk level by using norovirus data obtained from Japanese WWTPs. As a result, the necessary level of virus reduction during water reclamation was calculated to be a 3- to 6-log reduction (Fig. 5). In the case of agricultural irrigation for crops that are eaten raw, a >5-log reduction is required, which is almost the same as stipulated in the California Title 22 regulations for reclaimed wastewater [6].

3. Water reuse project on Okinawa Island

3.1. Water resource management

The main island of Okinawa (Okinawa Island) has among the most severe water shortages of any area in Japan, and it experienced serious water shortages from the 1970s to the 1990s. The most serious drought occurred from 1981 to 1982 and caused water supply restrictions lasting 326 days. To solve the water shortage, the Okinawa central government has developed a unique water resource management strategy by constructing dams, subsurface dams, a desalination plant, and water reclamation facilities. Eleven dams have been constructed in the northern part of the island since 1980 (Fig. 6). These dams doubled the water intake and accounted for 78% of water supply of the island in 2013 [13]. In addition, a desalination plant was constructed in 1997 in case of drought, although this consumes a large amount of energy. The water supply from the dams and desalination plant can meet the urban water demand. However, environmental issues hamper further construction of dams in the northern part which is the habitat of several endangered species.

Since the 11 dams could not allow for the stable water supply to the agricultural area in the southern part of the island, two subsurface dams were constructed in 2000 in the most southern area. Subsurface dams are a kind of reservoir of groundwater with a non-permeable wall constructed under the soil which backs up and impounds groundwater that would otherwise run into the sea. These dams provide groundwater to the farmland (1,352 ha) over the underground reservoirs so that the farmers can grow profitable vegetables, flowers, and tropical fruits. However, these dams are not available in the other areas because subsurface dams can be constructed only where the geological and soil factors are appropriate.

Reclaimed water began to attract attention as an alternative water resource in the central southern area in which five wastewater treatment plants discharge 270,000 m³/day of treated wastewater. In 2002, Naha

Table 2
Quality standards for reclaimed water in Japan [11].

| | Toilet flushing | Sprinkling | Landscape irrigation | Recreational applications |
|------------------------------|---------------------------|---------------------------|----------------------|---------------------------|
| <i>E. coli</i> | Not detected | Not detected | – | Not detected |
| Total coliforms [CFU/100 mL] | – | – | 1,000 | – |
| Turbidity [mg-kaolin/L] | ≤2 | ≤2 | ≤2 | ≤2 |
| pH | 5.8–8.6 | 5.8–8.6 | 5.8–8.6 | 5.8–8.6 |
| Appearance | Not unpleasant | Not unpleasant | Not unpleasant | Not unpleasant |
| Color [Color unit] | – | – | ≤40 | ≤10 |
| Odor | Not unpleasant | Not unpleasant | Not unpleasant | Not unpleasant |
| Chlorine residual [mg/L] | Free: ≥0.1 Total: ≥0.4 | Free: ≥0.1 Total: ≥0.4 | – | Free: ≥0.1 Total: ≥0.4 |

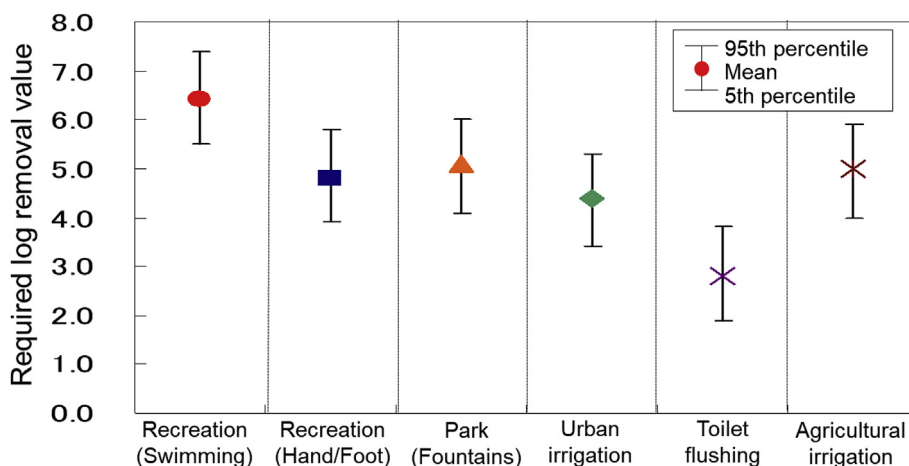

Fig. 5. Required viral reduction after Japanese secondary treatment equivalent to 10^{-6} DALY per person per year.

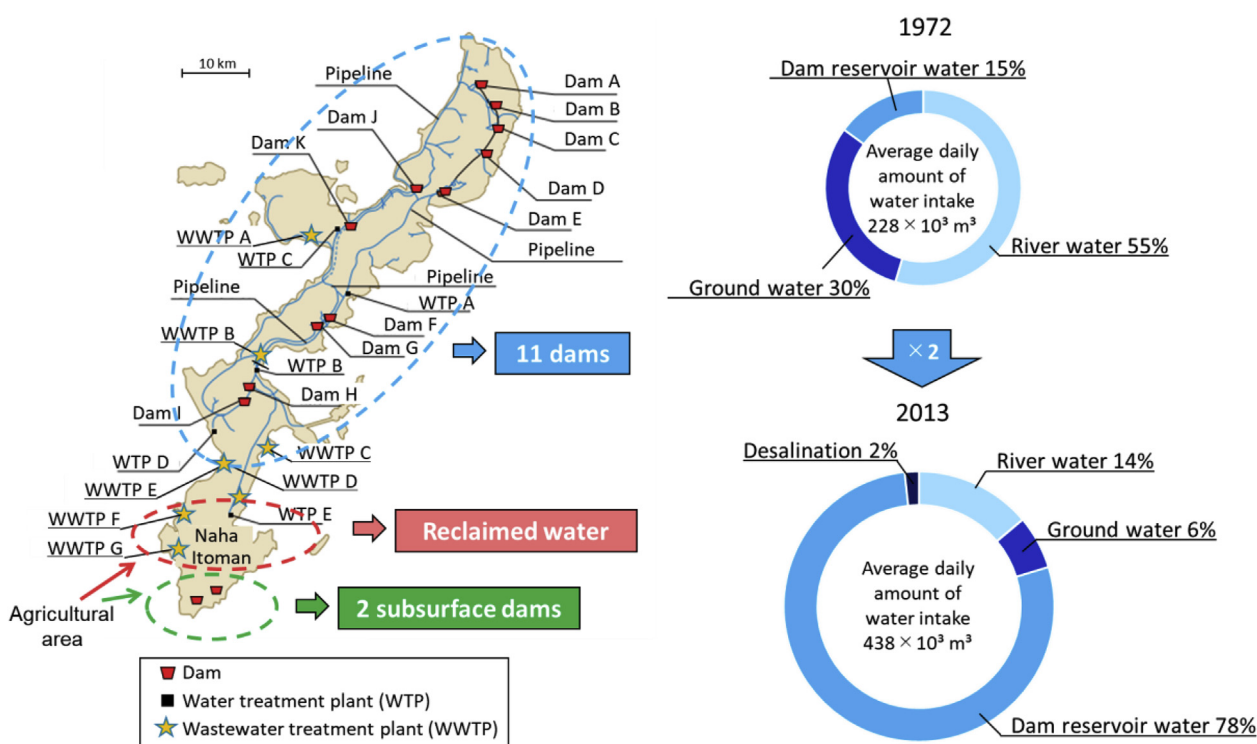

Fig. 6. Water resource management on Okinawa Island [13].

city launched a big water reclamation project for reuse of water in urban and agricultural applications. The Naha WWTP applied advanced wastewater treatments such as biological membrane filtration and ozonation. Reclaimed water ($600\text{--}700 \text{ m}^3/\text{day}$) was supplied to urban areas in Naha city and used for sprinkling lawns and trees and toilet flushing at commercial facilities. The reclaimed water was also supposed to be supplied to 25 km^2 of farmland as irrigation water. However, the agricultural water reuse project was suspended in 2005 because of the high water cost and public concerns over the safety of the reclaimed water. In 2012, the agricultural water reuse project was restarted with a wastewater treatment plant in Itoman city, which was located much closer to the farmland than the Naha WWTP, affording more cost-effective water reuse. In this project, UF membranes were considered as a more cost-effective reclamation process and the removal performance of UF membranes for viruses was evaluated at pilot scale.

3.2. Virus removal by UF + UV process

To develop an energy-efficient water reclamation process for agricultural reuse of water, we focused on UF membranes with a nominal pore size of 10 nm because the membrane was expected to effectively remove viruses with low applied pressure. To evaluate the removal performance of the UF process for viruses, MS2 phages, which are similar in size and shape to noroviruses, were selected as alternative indicators and their removal rates were measured in laboratory- and pilot-scale UF processes. The UF process provided only 1- to 2-log reduction values (LRVs) for MS2 phages. Even though the LRVs of MS2 phages increased to 3-log as the membrane became fouled, the UF process could not achieve the 5-log reduction necessary for agricultural water reuse. This result suggested that a single stage of UF process was not enough and that additional processes would be necessary to improve the LRVs of viruses. Coagulation, UF, NF, and RO membrane processes were selected as

candidates for the additional treatment. The effects of pretreatment by coagulation, and posttreatment by UV, NF, or RO on virus removal were evaluated by installing a pilot-scale treatment system in the Itoman WWTP (Fig. 7). The system had a capacity of 10 m³/day and constantly received secondary effluent. LRVs of each treatment train were evaluated by spiking the feed tank with MS2 phages. Among the four treatment processes, the treatment trains of 1) UF + UV, 2) UF + NF, and 3) UF + RO effectively removed MS2 phages and could achieve a tolerable risk level by WHO standards. For example, the UF + UV system constantly provided >5.2-log removal rates during the long-term operation. Considering the energy consumption as well as the removal performance, the UF + UV process was selected as the most suitable and viable option for agricultural water reuse (Table 3).

3.3. Feasibility study for applying the UF + UV process to agricultural water reuse

Based on the results obtained from the JST CREST project, Itoman city launched a demonstration project, the so-called B-DASH project, which was financially supported by the Ministry of Land Infrastructure, Transport and Tourism. The objectives of the demonstration project were to verify that the UF + UV process could provide LRVs of greater than 5.2-log, equivalent to the California Title 22 water reuse standard, and that the cost was lower than that of the California Title 22 treatment facility. A demonstration plant with a capacity of 1,000 m³/day was constructed in the Itoman WWTP, and it started operation in 2015.

Since spiking with MS2 phages was not possible on a demonstration scale, indigenous phages were used as alternative indicators. In this project, F-RNA phages discriminated into GI, GII, GIII, and GIV genotypes were used for the evaluation and were measured by the Integrated Cell Culture-PCR method, which can enumerate active phages. GI and GII genotypes existed more abundantly than the others in secondary effluent, and their LRVs by the full-scale UF process were verified to be 1 log. These reduction levels were similar to that of the MS2 phages obtained in pilot-scale experiments mentioned in the previous section.

Prior to the evaluation of LRVs with the full-scale UV process, laboratory-scale experiments were conducted to compare the sensitivity of MS2 phages and the four F-RNA phage genotypes to UV irradiation. GI genotype phages exhibited sensitivity similar to that of MS2 phages and

had a higher tolerance to UV irradiation compared to GII genotype phages. Based on this result, GI genotype F-RNA phages were selected as alternative indicators and were used for the evaluation of virus removal by the full-scale UF + UV processes. Among several sampling campaigns at the demonstration plant, GI genotype F-RNA phages were detected only once and the LRVs reached 6 logs. This result demonstrated that the full-scale UF + UV process had the capacity to provide >5.2-log reduction for viruses.

To assess the economic competitiveness of the UF + UV process compared with the California Title 22 system, the energy consumption was calculated based on the demonstration plant operation. Compared with the California Title 22 system, the UF + UV system showed 27% lower operation and maintenance costs and 14% lower life cycle cost (Fig. 8). These results indicate that the proposed process can be an economically viable option and applicable to agricultural water reuse in Itoman city. At present, the reclaimed water produced in the demonstration plant is delivered to farmland by tank lorry and is used to irrigate vegetables that are eaten raw. The methodologies of the risk assessment and energy evaluation used in the CREST project helped to formulate ISO 20426:2018 (i.e. *Guidelines for health risk assessment and management for non-potable water reuse*) and ISO 20468, for which Japan undertook secretariat work [12].

3.4. UF membrane integrity test

The UF + UV process was proven to provide >5.2-log reduction values for viruses. However, breakage of the hollow-fiber UF membrane might cause a decrease in LRVs and adversely affect the reclaimed water quality. Therefore, the effect of UF membrane breakage on virus removal was evaluated at pilot scale by artificially cutting the hollow fibers of a UF membrane element which consists of 1,000 fibers. As the number of cut fibers increased from 1 to 10, *E. coli* concentrations in the UF filtrate increased sharply, while the concentration of F-RNA phages in UF filtrate increased only slightly (Fig. 9). The breakage of UF fibers decreased the removal rates for both *E. coli* and F-RNA phages. However, the UV process following the UF process successfully reduced the *E. coli* level to below the limit of detection. This result indicates that the UF + UV process can effectively remove *E. coli* even when the UF membrane fibers sustain some damage. On the other hand, the UV process resulted in

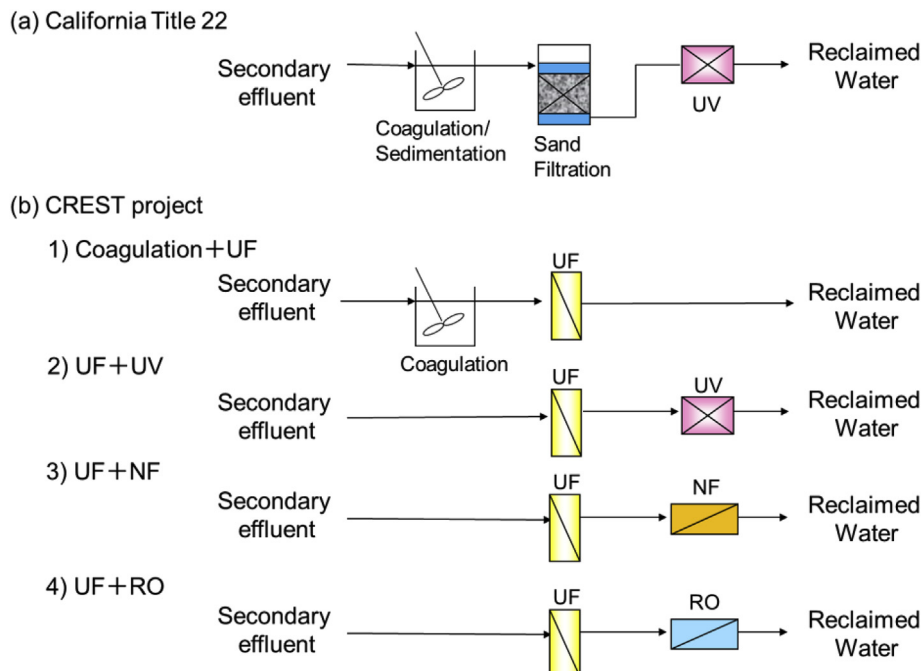

Fig. 7. Schematic diagram of treatment trains (a) in California Title 22 and (b) selected in CREST project.

Table 3
Energy consumption and risk assessment for various water reuse applications [14].

| Tertiary treatment | Energy consumption ^a | Agricultural application ^b | Urban application ^b | | | |
|---|---------------------------------|---------------------------------------|--------------------------------|-----------------|------------------------|-----------------------|
| | | Consumer/Worker | Toilet flushing | Lawn irrigation | Recreation (hand/foot) | Recreation (swimming) |
| CREST Project — ^c | ⊙ | × | × | × | × | × |
| Coagulation + UF | ○ | × | ○ | ○ | × | × |
| UF + UV | ○ | ○ | ○ | ○ | ○ | × |
| UF + NF | △ | ○ | ○ | ○ | ○ | ○ |
| UF + RO | × | ○ | ○ | ○ | ○ | ○ |
| California Title 22 Coagulation + Sand filtration + UV | ○ | ○ | ○ | ○ | ○ | × |

^a ⊙: small, ○: moderate, △: large, × : quite large.

^b ○:safe ($\leq 10^{-6}$ DALY per person per year), × : not acceptable ($>10^{-6}$).

^c Results for untreated secondary effluent.

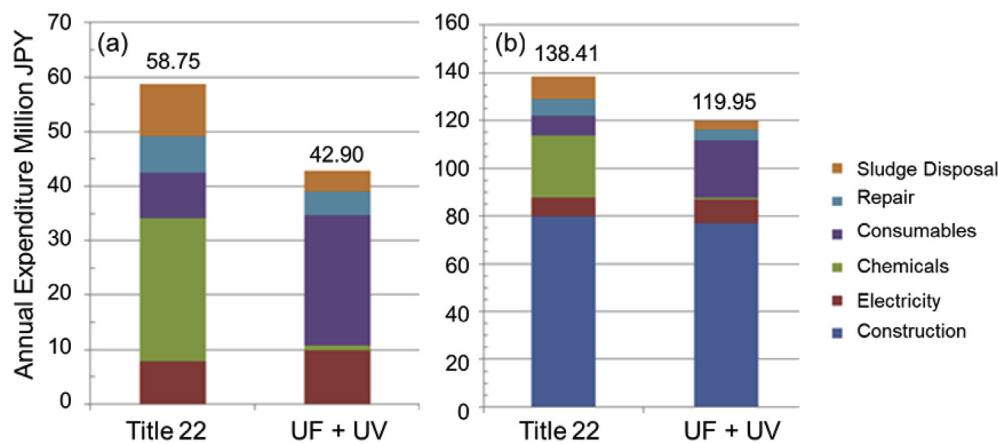

Fig. 8. Comparison of (a) operation and maintenance costs and (b) life cycle cost between the California Title 22 water reclamation system and the water reclamation system in the CREST project.

limited removal rates for F-RNA phages, probably because small particles leaked out from the damaged UF fibers and inhibited the UV irradiation. Therefore, monitoring of UF membrane integrity is important for ensuring virus removal.

Our previous research suggests that a high-sensitive turbidity meter is a useful tool to detect the breakage of UF membrane fibers [16]. According to the previous study, the high-sensitive turbidity meter allows detection of the increased turbidity levels in the UF filtrate with the increased number of cut fibers. By continuously monitoring the turbidity levels across the UF + UV system, the system can be shut down automatically to ensure the quality of the reclaimed water and can guarantee the reduction of pathogens to a safe level during the reclamation process.

3.5. Public acceptance of agricultural reuse of water in Itoman city

The reclaimed water produced in the demonstration plant was sent by truck to farms in Itoman city and used to cultivate vegetables. The effects of the reclaimed water on crop productivity in some farmland was evaluated by growing vegetables with the reclaimed water and with conventional irrigation water which contains farm drainage and municipal wastewater. According to the farmers, using reclaimed water increased crop productivity and also increased the safety of irrigation water. In addition, reclaimed water led to reduced consumption of fertilizer, which is probably due to nutrients remaining in the reclaimed water. In interviews, farmers reported that they were generally satisfied utilizing reclaimed water due to the increased crop productivity and safety of the irrigation water as well as the decreased consumption of fertilizer.

The crops harvested in the demonstration farms were shipped to a

supermarket managed by Itoman Agriculture Cooperatives. To evaluate the acceptance of the vegetables cultivated with the reclaimed water, customers coming to buy vegetables at the supermarket were asked to complete a questionnaire survey. Customers' acceptance of the vegetables was investigated after providing the customers with 1) no explanation about the reclaimed water project in Itoman city and the safety of the reclaimed water, 2) explanation about the water reuse project, and 3) additional explanation about the safety of reclaimed water. By explaining the water reuse project and reclaimed water quality, acceptance of the vegetables increased from 40% to 60%. Based on this result, public acceptance of agricultural reuse of water can be increased in Itoman city by carrying out public relations activities. To obtain more public acceptance, Itoman city has provided public education and outreach activities such as producing videos to explain the water reuse project, and conducting technical tours of the demonstration plants and the farms utilizing reclaimed water (Fig. 10).

3.6. Innovative water reuse scheme to integrate agricultural and industrial reuse of water

In addition to agricultural irrigation water, the demand for industrial water and irrigation water for golf courses and other sports facilities has been increasing in Itoman city. The estimated demand for agricultural, industrial, and urban water in Itoman city is 8,200 m³/day. Considering that the Itoman WWTP has a capacity of 10,000 m³/d, the increasing water demand can be met by producing and applying reclaimed water. Utilizing reclaimed water in Itoman city for industrial activities and the other applications has three advantages: 1) it allows for efficient use of reclaimed water, 2) it meets the increasing demand for industrial water,

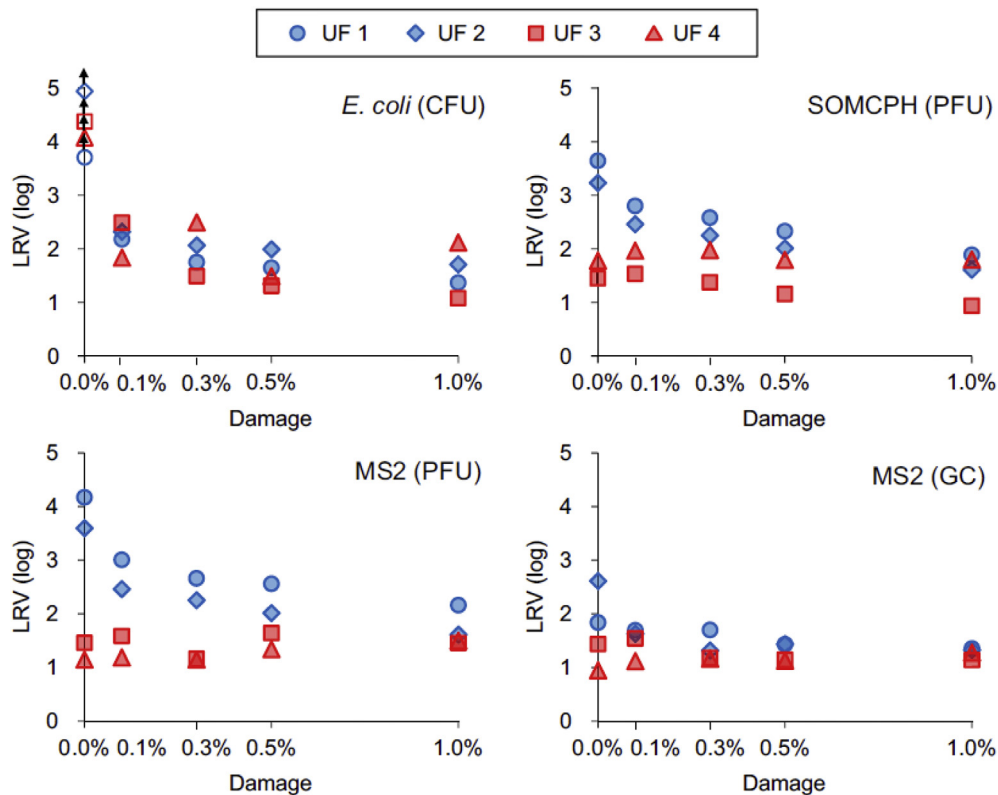

Fig. 9. LRVs of *E. coli*, Somatic coliphages (SOMCPH), and spiked MS2 phages in the fiber breakage tests using UF1–UF4. UF1–UF4 have 1, 3, 5, or 10 damaged fibers among 1,000, respectively [15].

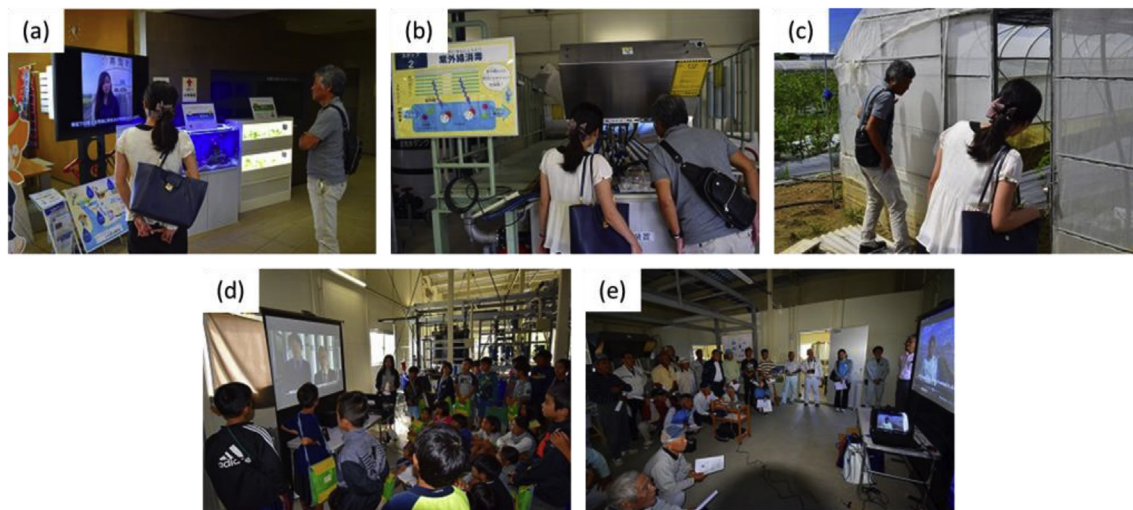

Fig. 10. Public education and outreach activities in Itoman city. (a) video instruction, (b) site visit to demonstration plant, (c) site visit to vegetable farms, (d) instruction to primary school students, and (e) instruction to Japan Agricultural (JA) Cooperative supermarket staff.

and 3) it reduces the amount of water that needs to be stored in the dams that are important reservoirs for the supply of tap water on Okinawa Island. Since the demand for agricultural irrigation water fluctuates seasonally because irrigation requirements are greatest in summer, the surplus of reclaimed water can be applied to industrial activities and other applications if the water quality is acceptable. In addition, the water reuse business can be economically feasible by utilizing the existing industrial water pipelines for reclaimed water supply and save the cost for pipe construction. This water reuse project is based on a new concept and can be an innovative water reuse business model. In order to

investigate the applicability of reclaimed water for industrial activities, a pilot-scale UF + RO system was installed in Itoman WWTP. The water quality of reclaimed water obtained from the UF + RO system was measured and compared with actual industrial water in Itoman Industrial Park. In addition, a questionnaire survey was conducted with companies in Itoman Industrial Park to investigate the current uses of industrial water and determine the required water quality and acceptable cost of reclaimed water. Furthermore, the cost of reclaimed water produced by the UF + RO process was estimated to assess the profitability of a water reuse business in Itoman city.

3.6.1. Comparison of water quality between reclaimed water and industrial water

To evaluate the water quality of reclaimed water, a pilot-scale UF + RO system was set up in a wastewater treatment plant in Itoman city to continuously receive secondary effluent from the wastewater treatment plant (Fig. 11). Grab samples were taken across the water reclamation treatment trains. To compare the water quality of reclaimed water with industrial water, industrial water samples were collected from six companies located in the industrial park in Itoman city (Table 4). For comparison of water quality between the reclaimed and industrial water, the concentrations of total organic carbon (TOC), total nitrogen (TN), nitrite nitrogen (NO₂-N), nitrate nitrogen (NO₃-N), ammonium nitrogen (NH₄-N), total dissolved solid (TDS), salts, and metals were determined.

TOC levels in RO permeate were lower than the values obtained from the industrial water samples (Fig. 12a). On the other hand, the RO permeate showed higher levels of TN and NH₄-N compared to the industrial water samples (Fig. 12a). The concentrations of Na, Ca, Mg, and Cl⁻ in RO permeate were lower than the industrial water samples (Fig. 12b). Since the RO process provided high removal rates for salts (>98%), the UF + RO system could produce reclaimed water with levels of salts lower than in the industrial water.

3.6.2. Questionnaire survey to understand the demand for industrial water

A questionnaire survey of companies in Itoman Industrial Park was conducted to 1) understand the acceptable cost for using reclaimed water, and 2) to investigate the current uses of industrial water and tap water. Among the 261 companies sent surveys, responses were obtained from 95 companies: 13 out of 95 companies used industrial water and the other 82 companies received tap water.

Most users of industrial water (9 out of 13 companies, 69%) answered that reclaimed water would be acceptable if the cost were lower than the cost of industrial water (35 yen/m³) (Fig. 13). Among tap water users, 45% (37 out of 82 companies) answered they would use reclaimed water if the cost were lower than the cost of tap water (200 yen/m³) (Fig. 13). These results indicate that reclaimed water is more readily accepted by tap water users than industrial water users. To further understand the demand for water, the amount of water consumed by users of tap water was investigated. Among the 37 companies that answered they would accept reclaimed water if it were below the cost of tap water, 7 companies were food companies and consumed 68% of the tap water (Fig. 14). These results suggest that food companies consume large amounts of tap water and that reclaimed water should be supplied to the food companies that currently use tap water.

3.6.3. Profitability of reclaimed water for industrial applications

To assess the profitability of reclaimed water for industrial applications, the cost of reclaimed water supply was estimated by calculating the initial and running costs of the UF + RO processes. In this study, reclaimed water was assumed to be supplied to the industrial area in Itoman city by using distribution pipes currently used for industrial water supply so that no additional construction of distribution pipes for reclaimed water is required (Fig. 15).

Assuming the construction of a water reclamation plant with a capacity of 2,000 m³/day, the cost to supply reclaimed water was estimated to be 125.6 yen/m³, which is higher than the current supply cost of tap

Table 4
Investigated companies.

| Industrial company | Additional treatment | Application of industrial water |
|--------------------------------|----------------------|--|
| Noodle manufacturer | Yes | Cooling/Boiler water |
| Sea food manufacturer | Yes | Cooling/Cleaning water |
| Table salt manufacturer | Yes | Boiler/Cleaning water |
| Concrete manufacturer | No | Material for concrete/ Cleaning water |
| Beach hut | No | Cleaning water |
| Automobile maintenance company | No | Cleaning water |

water (97.4 yen/m³). On the other hand, the reclaimed water supply would become economically superior with the construction of a larger reclaimed water plant with capacity of 5,000 m³/day or 10,000 m³/day, with an estimated reclaimed water supply cost of 87.4 yen/m³ and 68.5 yen/m³ in each case. These results indicate that the installation of a water reclamation facility is a viable option for supplying water to the industrial area in Itoman city if industrial water demand becomes higher than the capacity of current industrial water supply system.

4. Promising technologies for water reuse

To further reduce cost and energy consumption, innovative reclamation technologies are needed. Japanese research groups in academic institutions and private companies have been developing promising technologies for water reuse, even though some of them are still at laboratory-scale development. For example, innovative ozone gas generators can be produced with a drastic change in the ozone generation process in which the loss of oxygen radicals is inhibited. The resulting improvement in the efficiency of ozone gas generation can dramatically reduce the energy consumption of ozonation systems. A photocatalytic ceramic membrane process is also under development for water filtration and oxidation. Photocatalytic materials, in particular titanium dioxide (TiO₂), are capable of producing highly reactive oxidants such as hydroxyl radicals under UV radiation, which allows effective decomposition of organic pollutants in water. Our research group has been assessing the performance of porous ceramic membranes coated with TiO₂ under UV-LED radiation to remove pharmaceuticals and personal care products (PPCPs) in wastewater. The process has been demonstrated to provide higher removal rates for some PPCPs compared to a single UV or UV/TiO₂ systems [17]. Regarding RO membranes, developing membranes with high resistance to chlorine and fouling is a priority research area for energy-efficient water reclamation. In this regard, robust RO membranes have been developed by mixing nanomaterials such as carbon nanotubes (CNTs) into polyamide membranes. Laboratory-scale experiments have demonstrated that the developed robust carbon membranes provide higher permeability, chlorine resistance, and fouling resistance compared to conventional polyamide membranes [18,19]. Recently, pilot-scale experiments have been started to evaluate the operational and removal performances of a novel membrane using spiral-wound membrane elements. Simultaneously, our research group has been developing technologies for safety evaluation tools by using *in vitro* assays with fish nervous signal receptors or G protein-coupled receptor assays for eco-toxicity [20,21].

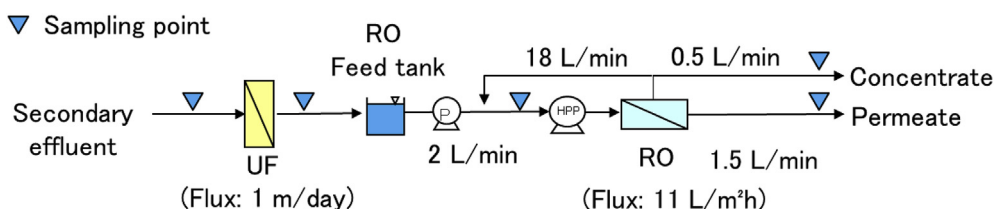

Fig. 11. Schematic diagram of the water reclamation process and sampling points. P: pump. HPP: high pressure pump.

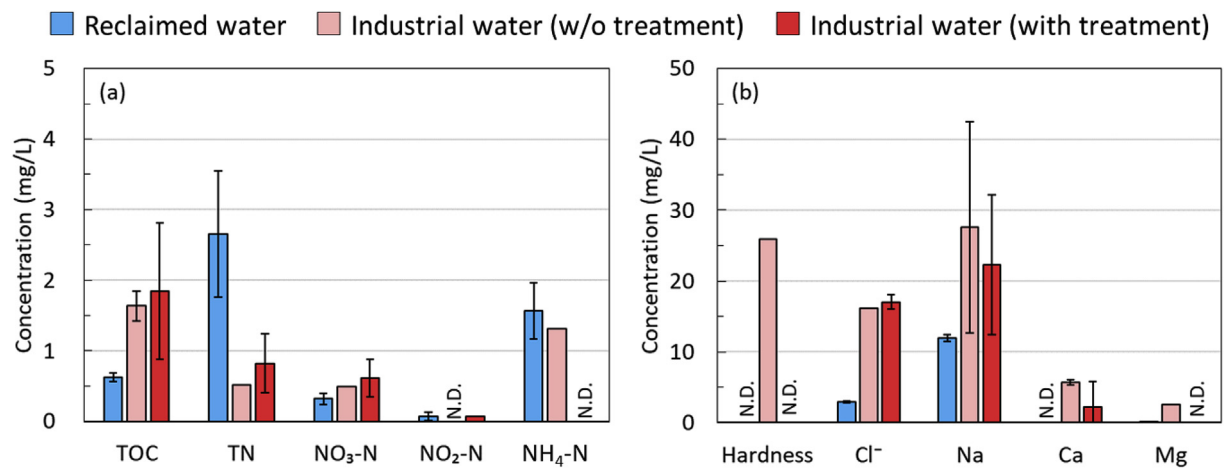

Fig. 12. Water qualities of reclaimed water and industrial water (average ± standard deviation, N.D. not detected, N.A. not available).

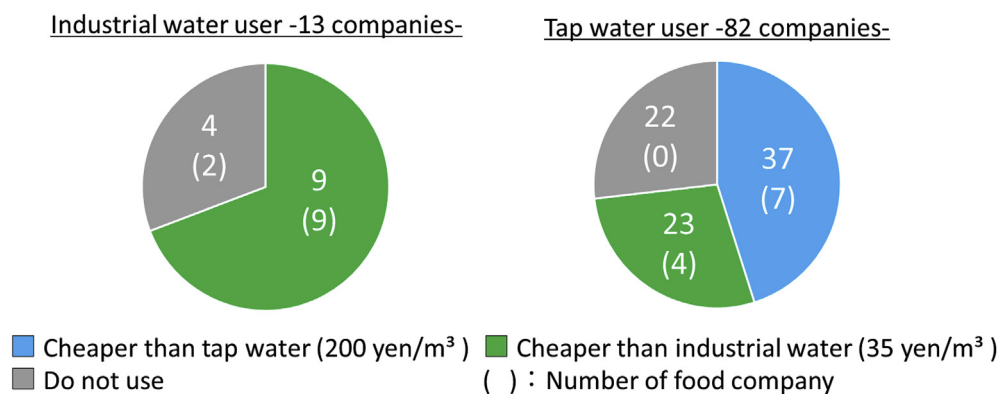

Fig. 13. Number of companies classified according to the acceptable cost of reclaimed water.

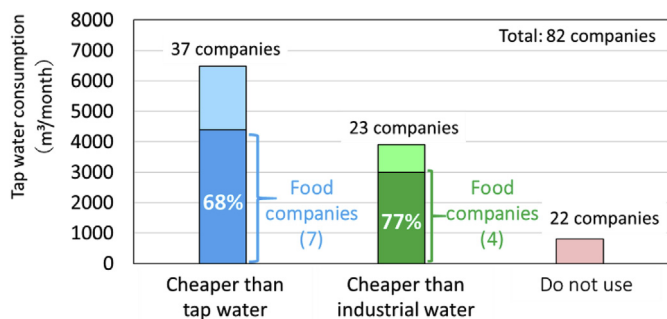

Fig. 14. The amount of tap water consumption by 82 companies. The companies are categorized according to their answers for acceptable cost of reclaimed water.

In addition to the cost and energy issues, emerging challenges are issues of antimicrobial resistant bacteria (ARB) and antimicrobial resistant genes (ARGs) in water reuse [22,23]. The difficulty of control of these issues comes from the vertical and horizontal transfer of ARB and ARGs. Levels of acceptance of reclaimed water, control technologies for reclamation processes, and pipe lines are the next big challenges in water reuse. Applicability of promising processes will be evaluated in the near future to control and minimize the risks of ARGs in reclaimed water.

5. Conclusions

Water reuse is effective option all over the world for saving water

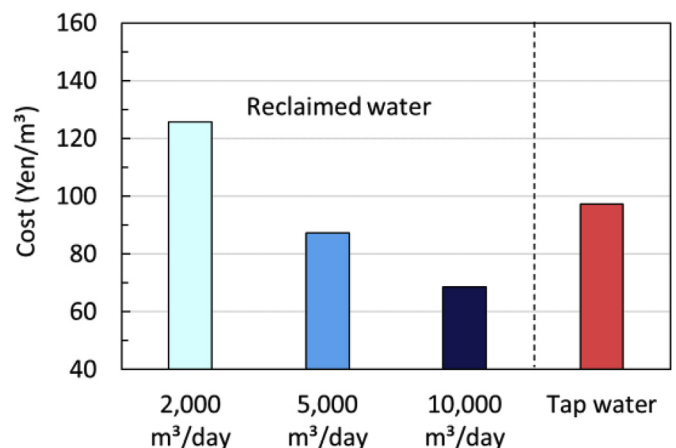

Fig. 15. Estimated cost of reclaimed water.

resources, reducing the environmental impacts from the discharge of treated wastewater, and reducing the cost and energy involved with water resource management. Japan has been developing non-potable water reuse systems in several cities mainly for urban applications such as toilet flushing, urban stream water augmentation, and landscape irrigation. However, reclaimed water utilization in Japan is still limited due to the inadequate quality standards for reclaimed water and the high energy consumption of water reclamation facilities. To promote water reuse, the Japanese government established several laws in 2014 and

2015 which highlight the importance of water reuse in water resource management. In addition, the CREST project was carried out during 2010–2015 in order to develop an energy-efficient water reclamation process with membrane technologies and ozonation. As a result of comprehensive evaluation of process performances and economic feasibility, a UF + UV process was proven to provide removal of viruses sufficient to allow for agricultural water reuse with lower cost than the process stipulated in the California Title 22 regulations. The methodologies of the risk assessment and energy evaluation used in the CREST project helped to formulate ISO 20426:2018 and ISO 20468, in which Japan undertook secretariat work. In addition to agricultural water reuse, an innovative water reuse scheme is now in the planning stages in Itoman city in Okinawa to integrate water reuse systems with the existing industrial water supply systems. Other innovative technologies are also being developed in Japan to reduce the cost and energy of water reclamation. Acknowledgements The water reuse projects introduced here were supported by the Core Research for Evolutional Science and Technology (CREST) grant for ‘Innovative Technologies and Systems for Research on Sustainable Water Use’ by the Japan Science and Technology Agency (JST), and by the Breakthrough by Dynamic Approach in Sewage High Technology (B-DASH) project of the National Institute for Land and Infrastructure Management (NILIM), Japan.

Declaration of competing interest

The authors declare that they have no known competing financial interests or personal relationships that could have appeared to influence the work reported in this paper.

References

- [1] T. Asano, F. Burton, H. Leverenz, *Water Reuse: Issues, Technologies, and Applications*, McGRAW-HILL, 2007.
- [2] V. Lazarova, T. Asano, A. Bahri, J. Anderson, *Milestones in Water Reuse*, IWA Publishing, 2013.
- [3] Ministry of Land, Infrastructure Transport and tourism (MLIT). Current state of water resources in Japan. https://www.mlit.go.jp/tochimizushigen/mizsei/water_resources/contents/current_state2.html. (Accessed 10 March 2020).
- [4] T. Asano, M. Maeda, M. Tasaki, Wastewater reclamation and reuse in Japan: overview and implementation examples, *Water Sci. Technol.* 34 (1996) 219–226.
- [5] M. Ogoshi, Y. Suzuki, T. Asano, Water reuse in Japan, *Water Sci. Technol.* 43 (2001) 17–23.
- [6] California Department of Health Services S, *Water Recycling Criteria*. California Code of Regulations, 2000. Title 22, Division 4, (Chapter 3).
- [7] Asian-Pacific City Summit, Aiming for a water conservation-conscious city: Fukuoka city. <http://apcs.city.fukuoka.lg.jp/en/news/newsfukuoka/000345.html>. (Accessed 10 March 2020).
- [8] K. Udo, Fukuoka wastewater reuse strategy for water sustainability (in Japanese), *Civil. Eng. J.* 56 (2014) 38–41.
- [9] Bureau of Sewerage, Tokyo metropolitan government. Ochiai water reclamation center. <https://www.gesui.metro.tokyo.lg.jp/english/pdf/ochiai.pdf>. (Accessed 10 March 2020).
- [10] The secretariat of the headquarters for water cycle policy. 水循環に関する主な取組状況. https://www.kantei.go.jp/jp/singi/mizu_junkan/yuushikisha/dai2/siryu1.pdf. (Accessed 10 March 2020).
- [11] Ministry of Land, Infrastructure Transport and tourism (MLIT). 下水処理水の再利用水質基準等 マニュアル. <https://www.mlit.go.jp/kisha/kisha05/04/040422/05.pdf>. (Accessed 10 March 2020).
- [12] World Health Organization, *Guidelines for the Safe Use of Wastewater, Excreta and Greywater - Volume 2: Wastewater Use in Agriculture*, 2006.
- [13] The Okinawa Prefectural Enterprise Bureau, Quantity of water intake according to water source per day (Okinawa Island). <http://www.eb.pref.okinawa.jp.e.sa.hp.ranser.com/kids/doko/dam.html>. (Accessed 10 March 2020).
- [14] 戦略的創造研究推進事業 CREST 「21世紀型都市水循環系の構築のための水再生技術の開発と評価」 終了報告書, 2015.
- [15] S. Lee, N. Yamashita, H. Tanaka, How fiber breakage reduces microorganism removal in ultrafiltration for wastewater reclamation, *Food Environ. Virol.* 11 (2019) 167–177.
- [16] Ministry of Land, Infrastructure Transport and Tourism (MLIT). Guideline for introducing an advanced wastewater reclamation system using ultrafiltration membrane and ultraviolet disinfection (in Japanese). <http://www.nilim.go.jp/lab/bcg/siryou/tnn/tnn1011pdf/ks1011.pdf>. (Accessed 8 May 2020).
- [17] R. Homma, T. Makino, N. Nakada, S. Sameshima, H. Tanaka, Control of fouling by TiO₂ photocatalysis and ceramic flat membrane filtration toward water reuse (in Japanese), *EICA* 24 (2019) 32.
- [18] K. Takeuchi, Y. Takizawa, H. Kitazawa, M. Fujii, K. Hosaka, J. Ortiz-Medina, A. Morelos-Gomez, R. Cruz-Silva, M. Fujishige, N. Akuzawa, M. Endo, Salt rejection behavior of carbon nanotube-polyamide nanocomposite reverse osmosis membranes in several salt solutions, *Desalination* 443 (2018) 165–171.
- [19] R. Cruz-Silva, Y. Takizawa, A. Nakaruk, M. Katouda, A. Yamanaka, J. Ortiz-Medina, A. Morelos-Gomez, S. Tejima, M. Obata, K. Takeuchi, T. Noguchi, T. Hayashi, M. Terrones, M. Endo, New insights in the natural organic matter fouling mechanism of polyamide and nanocomposite multiwalled carbon nanotubes-polyamide membranes, *Environ. Sci. Technol.* 53 (2019) 6255–6263.
- [20] M. Ihara, A. Inoue, S. Hanamoto, H. Zhang, J. Aoki, H. Tanaka, Detection of physiological activities of G protein-coupled receptor-acting pharmaceuticals in wastewater, *Environ. Sci. Technol.* 49 (2015) 1903–1911.
- [21] M. Ihara, S. Hanamoto, O.M. Ihara, H. Zhang, H. Tanaka, Wastewater-derived antagonistic activities of G protein-coupled receptor-acting pharmaceuticals in river water, *J. Appl. Toxicol.* 40 (7) (2020) 908–917.
- [22] A. Christou, A. Agüera, J.M. Bayona, E. Cytryn, V. Fotopoulos, D. Lambropoulou, C.M. Manaia, C. Michael, M. Revitt, P. Schröder, D. Fatta-Kassinos, The potential implications of reclaimed wastewater reuse for irrigation on the agricultural environment: the knowns and unknowns of the fate of antibiotics and antibiotic resistant bacteria and resistance genes – a review, *Water Res.* 123 (2017) 448–467.
- [23] C.X. Hiller, U. Hübner, S. Fajnorova, T. Schwartz, J.E. Drewes, Antibiotic microbial resistance (AMR) removal efficiencies by conventional and advanced wastewater treatment processes: a review, *Sci. Total Environ.* 685 (2019) 596–608.