

# **An Outline of the Upper Cenozoic Deposits in the Chao Phraya Basin, Central Thailand**

by

M. N. ALEKSEEV and Yoshikazu TAKAYA

## **I. Introduction**

The present paper is based on field reconnaissance of the Quaternary deposits of the Central Thailand made by the authors during 1966 and the first half of 1967. The study has been conducted under the auspices of the ECAFE secretariat, Bangkok, Chulalongkorn University, Bangkok, and Kyoto University, Japan.

The great lowland of Thailand, known as the "Central Plain" is one of main physiographic divisions of the country. It comprises some 50,000 square kilometers, covering much of the drainage basin of the Mae Nam Chao Phraya and also Mae Klong drainage. This lowland is slightly inclined to the south, the altitude varying from 120 m above sea level in the North to about 1 to 2 m around Bangkok. Tectonically this lowland is an Upper Cenozoic sedimentary basin infilled by young, generally unconsolidated deposits several hundred meters thick.

The central part of the basin is topographically very flat and almost without exposures. The Cenozoic sediments are at their thickest here and the only stratigraphic information available is derived from bore holes. In contrast, the margin of the basin are characterized as the general shallow depth of bedrock and a correspondingly reduced thickness of unconsolidated sediments.

The principal objective of this investigation has been to establish a stratigraphic basis both for geological mapping and for the exploration of mineral resources, particularly placers. Study of the Upper Cenozoic deposits is important to the Southeastern Asia region, where alluvial and eluvial deposits constitute the sufficient basis of the mineral industry.

This is merely a first attempt on systematization of the Upper Cenozoic stratigraphy of the Central Plain and future work may necessitate corrections and the additions to the preliminary correlation made here. Nevertheless it is thought that a contribution has been made to our understanding of an important sequences in Southeastern Asia.

In the apparent dearth of fossils, morphological expression has been used in the establishment of stratigraphic units. The following international stratigraphic

indexes for the subdivision of the Upper Tertiary and the Quaternary have been used :

- Q<sub>4</sub> : Holocene
- Q<sub>3</sub> : Upper Pleistocene
- Q<sub>2</sub> : Middle Pleistocene
- Q<sub>1</sub> : Lower Pleistocene
- N<sub>2</sub> : Pliocene

## II. Status of the study of the Quaternary deposits in Thailand

Previous geological studies in the central area of Thailand has provided only some general data on Quaternary sequences. Detailed investigations of the Quaternary has not been carried out.

The first general outline of Quaternary deposits in Central Thailand was included in a bulletin of the geology and mineral resources of the country by Brown, Buravas, Charaljavanaphet and others (1951)<sup>1)</sup>. The authors have briefly described the physiography of the Chao Phraya Plain and its surrounding areas, and summarized the general lithologic characteristics of the Quaternary sediments. It has been noted that, according to boring data, the thickness of alluvium in the central part of the Chao Phraya valley exceeds 300 m. The seaward portion of this valley was said to include beds of deltaic character. Dark gray heavy clay overlies marine or estuarine marly beds, sands and gravels.

The geological and geomorphological situation of ferruginous laterites has also been outlined. Two different kinds of laterites were recognized ; young laterites developed on the low level terraces or planated surfaces and the mature high-level laterites. The latter was found on uplifted dissected terraces or other surfaces which have been preserved from erosion.

Regarding the paleontology of Quaternary in Thailand, Brown recorded the findings of fossil mammals excavated from gravel deposits on the bank of the Mae Nam Chao Phraya at Nakhon Sawan (Loc. 3).

In 1959, von Koenigswald<sup>9)</sup> published the results of his study on mammalian fossils from Thailand. Concerning the Quaternary material, he has noted as follows : "During a visit to Bangkok in November 1957, Dr. Boonsong Lekakul kindly showed me some finds in his collection, which have been discovered when building the Dechatiwongse Bridge, crossing the Mae Nam Chao Phraya at Nakhon Sawan. They consist of the greatest part of a fine *Hippopotamus* skull, the flat horn core of a large buffalo (*Bubalus*), and a nearly complete upper molar of *Stegodon*. This molar is large with much cement like those of *Stegodon ganesa* from the Indian Siwaliks, and not reduced like those of *Stegodon trigonocephalus*

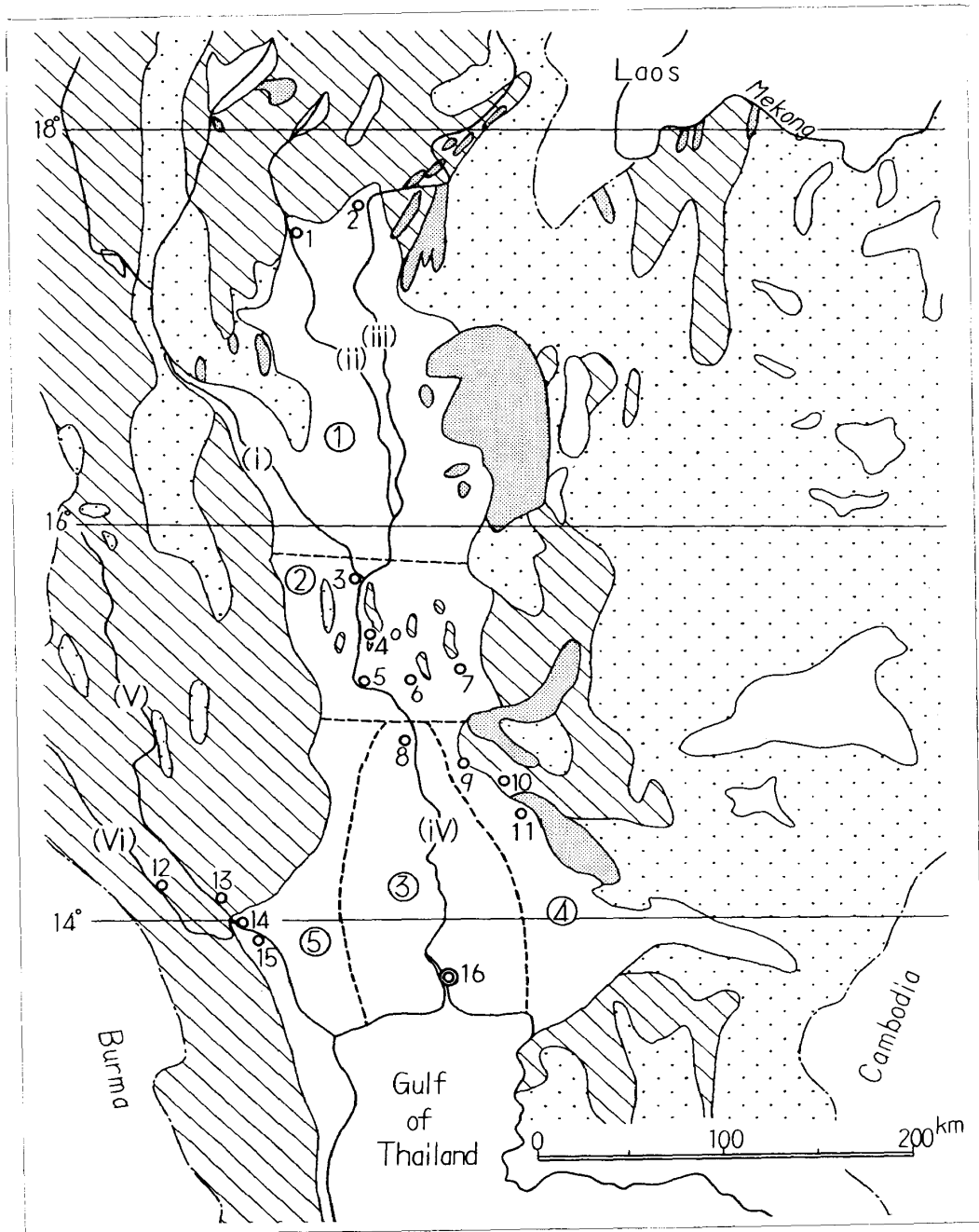

**Geology**

- Quaternary alluvium
- Tertiary igneous rocks
- Mesozoic rocks
- Paleozoic rocks

**Geomorphological Subdivision**

- ① Northern Basin
- ② Nakhon Sawan Area
- ③ Southern Basin
- ④ Eastern Marginal Area
- ⑤ Mae Klong Drainage

**River and Mountain**

- i Mae Nam Ping
- ii Mae Nam Yom
- iii Mae Nam Nan
- iv Mae Nam Chao Phraya
- v Mae Nam Kwae Yai
- vi Mae Nam Kwae Noi
- vii Kao Kieo
- viii Kao Phom

**Locality cited**

- 1. Si Sachanalai
- 2. Uttaradit

- 3. Nakhon Sawan
- 4. Phayuhakiri
- 5. Chainat
- 6. Takli
- 7. 37km milestone
- 8. Sing Buri
- 9. Lop Buri
- 10. Phra Phuttabat
- 11. Sara Buri
- 12. Ban Kao
- 13. Ban Lat Ya
- 14. Kanchana Buri
- 15. Ban Chukphi
- 16. Bangkok

**Fig. 1** Index map of Central Thailand

from Java. The age of this assemblage is most probably Middle Pleistocene.”

Finally, pebble-tool complex was discovered by H. R. van Heekeren in 1943-44 (van Heekeren, 1947 a, b and 1948)<sup>6)</sup> in the Kwae Noi valley. Most of the collected tools were Neolithic, few were probably Mesolithic and three pebble choppers had been identified as related to Lower Paleolithic age. His archeological studies were followed by those of K. G. Heider in 1956 (Heider 1960)<sup>7)</sup>. Unfortunately the geological setting of these archeological sites in fact was not recorded.

### III. Results of the present investigation

For convenience the Chao Phraya basin has been divided into five zones, viz ;

1. Northern Basin : The drainage of the three big tributaries of the Chao Phraya ; the Ping, the Yom and the Nan.
2. Nakhon Sawan Area : Zone of scattered monadnocks linking the Northern and Southern Basins.
3. Southern Basin : Mainly Bangkok Plain.
4. Sara Buri—Lop Buri Area : Eastern marginal area of the Southern Basin around Sara Buri (Loc. 11) and Lop Buri (Loc. 9).
5. Mae Klong Drainage : Mae Klong drainage including western marginal region of the Southern Basin.

The results of the investigation are given below.

#### 1. Northern Basin

This region is characterized by rolling topography with alternating swells and swales, elevated about 70 to 120 m above sea level can be commonly seen along the margin of the basin, and another more flat, actually more or less undulating topography of 40 to 60 m elevation is traceable along main river courses. This terrain pattern is probably the result of the erosion and deposition which have taken place through the Pliocene and Pleistocene.

The mode of occurrence of Pleistocene deposits and weathered rocks, and their mutual relationships are shown schematically in Fig. 1-i. So far as it has been

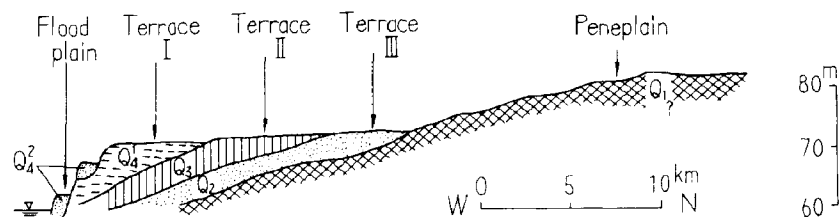

Fig. 1-i Schematic cross section of Quaternary sediments in Northern Basin, in the vicinity of Si Sachanalai (Loc. 1)

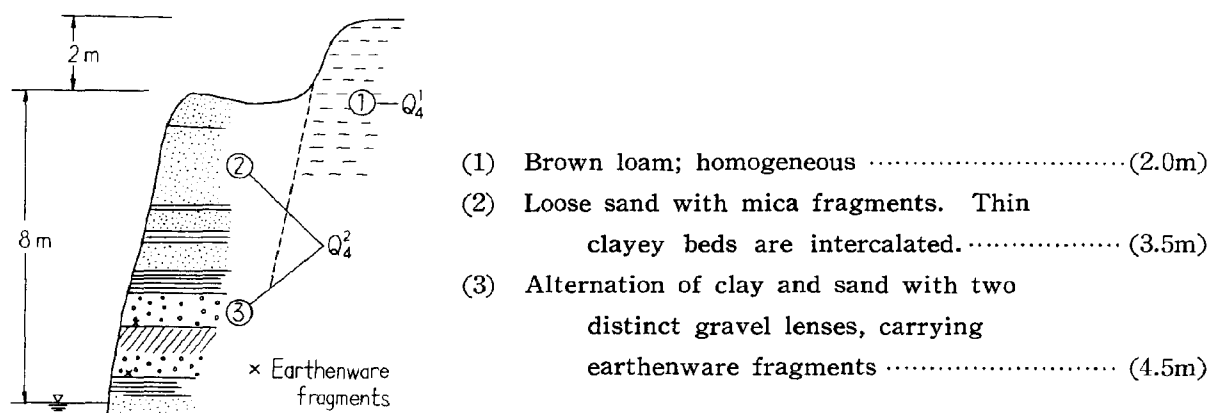

Fig. 1-ii Outcrop of the Flood Plain on the left bank of the Mae Nam Yom, 10 km south of Si Sachanalai

observed, the terrain seems to consist of five different kinds of geological bodies designated  $Q_4^2$ ,  $Q_4^1$ ,  $Q_3$ ,  $Q_2$ , and  $Q_1$ .

An outcrop of the Flood Plain ( $Q_4^2$ ) on the left bank of the Mae Nam Yom at Paklwai, 10 km south of Si Sachanalai (Loc. 1), is shown in Fig. 1-ii. Fragments of well known "Sawankalok earthenware" which are commonly intercalated in this formation indicate that the Flood Plain deposits are of historical age.

However, this figure does not represent the typical mode of the Flood Plain in this region. More commonly this feature exhibits a combinations of two thinner loose sand deposits of different height as shown Fig. 1-i.

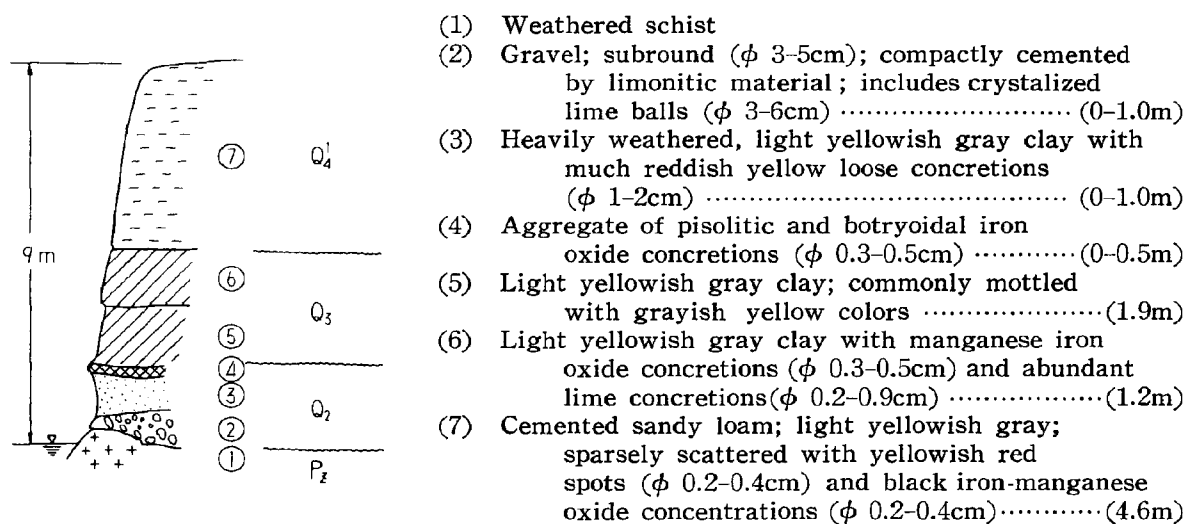
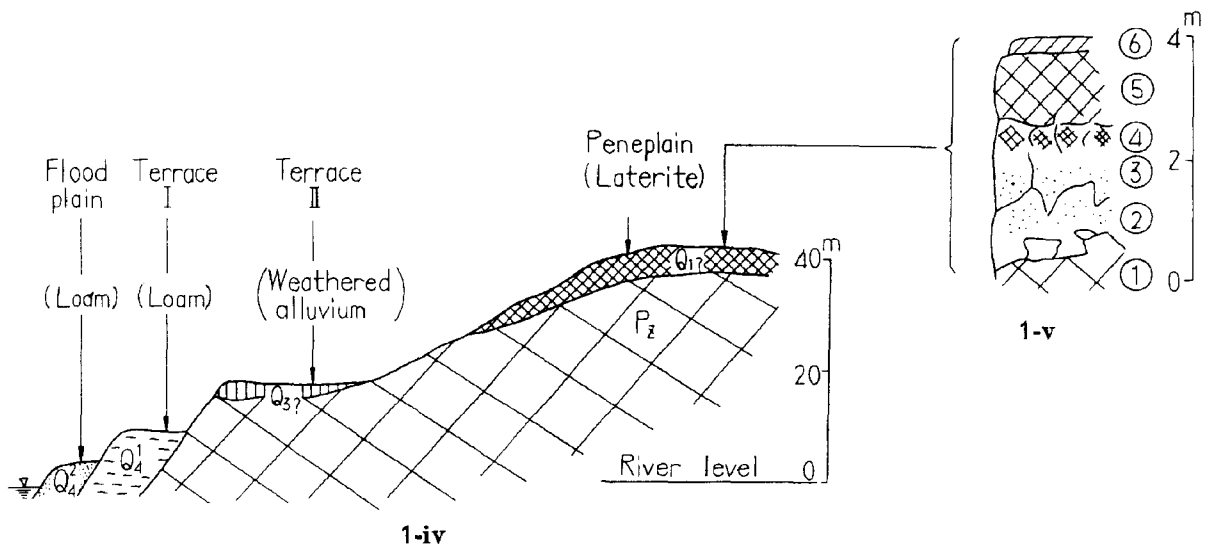

Fig. 1-iii Section on the left bank of the Mae Nam Yom, at Si Sachanalai (Loc.1)

The  $Q_2$ ,  $Q_3$  and  $Q_4^1$  horizons are well exposed on the left bank of the Mae Nam Yom at Si Sachanalai as shown in Fig. 1-iii. The  $Q_2$  unit is typically characterized by a thin top layer of lateritic material, and the  $Q_3$  by frequent incidence of pisolitic iron oxide concretions ( $\phi$ : 1 cm or less). The  $Q_4$  horizon contains only



**Fig. 1-iv** Sketch section of the Mae Nam Nan near Uttaradit (Loc. 2)

**Fig. 1-v** Profile of laterites near Wat Plaun

- (1) Undecomposed rock
- (2) Decomposed quartzitic rock
- (3) Light gray clay with quartz sand patches ; commonly mottled with various colored spots
- (4) Red to brick brown sandy clay ; reticulately mottled with light gray colors
- (5) Reddish brown hard laterite
- (6) Removed laterite (Talus deposits)

loosely cemented ferruginous concentrations and very small oolitic concretions. All these concretions and lateritic occurrence are thought to have been produced by weathering during breaks in deposition.

The  $Q_4^1$  horizon can usually be seen only in a narrow zone along the courses of the largest rivers. The  $Q_2$  and  $Q_3$  formations are situated further from the rivers, lying at increasingly shallow depth and finally being exposed directly on the ground surface to form the Terrace III and Terrace II as shown in Fig. 1-i. Their occurrence is quite widespread in the central part of the Northern Basin.

Assuming that the deposition of the Terrace I alluvium and normal fluvial downcutting took place under stable tectonic condition, it is possible to make some correlation these with the dated section of Southeastern Asia. In this case the time of deposition of the Terrace I alluvium approximately should correspond to Early Holocene—Latest Pleistocene. The pisolitic concretions might signify a period during which the  $Q_3$  formation had been exposed to the open air before the deposition of  $Q_4^1$  formation. In the same way the lateritic top layer of the  $Q_2$  formation suggests disconformity between the  $Q_2$  and  $Q_3$ . On the basis of this concept, the  $Q_3$  and  $Q_2$  formation seem most likely to be the Upper Pleistocene and Middle Pleistocene respectively.

A distinguishing feature of this basin are the widely distributed laterites.

Usually the laterites cap rolling topography of 120 m in height, which constitutes erosional remnants of the ancient rocks.

Two major stages of the development of laterites are known. One is along the Mae Nam Ping, where the laterites cap conglomerate (Cretaceous or Paleogene) and schist with an extent of at least 15 km×15 km. The other one is found near Uttaradit, where it extends over an area of almost 20 km×5 km trending E-W.

The outcrops showing the most complete lateritic profiles are near Wat Plaun on the Uttaradit(Loc. 2)—Si Sachanalai (Loc. 1) Highway, where laterites of 4 to 6 m in thickness cover the top of the hills and hillside slopes. Several zones may be distinguished in the lateritic profile near Wat Plaun as shown in Fig. 1-iv. Lateritization might have started in the Early Pleistocene in this basin.

## 2. Nakhon Sawan Area

Many monadnocks made of Paleozoic limestones and igneous rocks in lines trending N-S give a somewhat archipelago-like appearance to this part of the Chao Phraya basin. Three big tributaries, the Ping, Yom and Nan join together to form the Mae Nam Chao Phraya at Nakhon Sawan, forming boundary between the Northern Basin and the monadnock area, and run down due south between two big “inselbergs”, Kao Khieo (River vii) and Kao Phom (River viii) to the other big depression, the Southern Basin. Thus the monadnock zone appears as a bottle neck of the Chao Phraya basin linking the Northern and Southern Basins.

Average ground height in this zone along the Mae Nam Chao Phraya is about

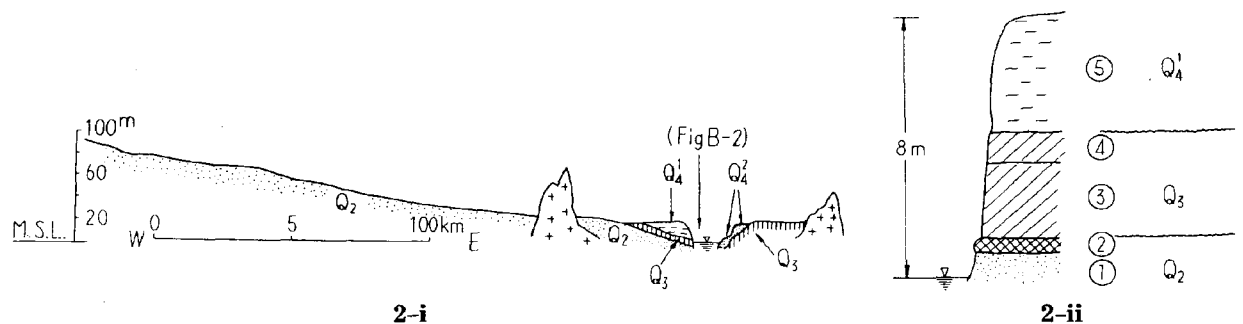

Fig. 2-i Schematic E-W cross section in Nakhon Sawan area

Fig. 2-ii Section on the left bank of the Mae Nam Chao Phraya, at Phayuhakiri (Loc. 4)

- (1) Heavily weathered coarse sand and silt; reticulately mottled in pale red, strong brown and light olive gray; contains much manganese iron oxide concretions ( $\phi$  0.2-0.4cm) and lime concretions( $\phi$  5-10cm).....(0.7m)
- (2) Heavily weathered brownish sandy clay with abundant iron oxide concretions ( $\phi$  0.2-1.2cm); in part transforms to a thin laterite layer of 2 to 3 cm thick.....(0.4m)
- (3) Olive gray clay; spotted with yellowish brown.....(2.3m)
- (4) Yellowish gray clay with iron oxide pisolitic concretions ( $\phi$  0.3-0.6 cm) ... (0.5m)
- (5) Very fine sand or sandy loam; dark brown; loose; non-stratified .....(4.0m)

20 m above sea level and it increases up to 60 to 70 m at the margins of the valley. A narrow belt near the river of some 7 km in width is comprised of numerous marshes and oxbow lakes. To either side is a drier area with undulating topography with abundant monadnocks.

Fig. 2-i shows a schematic E-W cross section of this region. Four kinds of geological bodies can be seen here. Fig. 2-ii shows the more detailed sketch of an outcrop on the Mae Nam Yom near Phayuhakiri (Loc. 4). This succession is quite similar to that of Si Sachanalai (Fig. 1-iii), apparently implying that the same kind of geological environment has taken place since Middle Pleistocene at least at this locality, in the narrow zone along the Mae Nam Chao Phraya.

One of the interesting point is that the most part of this Nakhon Sawan Area seems to consist of the Q<sub>2</sub> formation only, without any young covers. Though direct proof is insufficient, the fact that many fragments of lateritic material and the heavily weathered sand grains cover almost whole region suggests the possibility of the surface being of Terrace III.

Important paleontological discoveries were reported by von G. H. R. Koenigswald (1959)<sup>9)</sup>. This author identified *Hippopotamus* skull, *Bubalus* horn and an upper molar of *Stegodon* excavated during the construction of Dechatiwongse Bridge (Nakhon Sawan). This material was determined as Middle Pleistocene.

Some pebbles and sand are attached to these fossils. Judging from this fact and the general lithological character of the unconsolidated sediments in the vicinity, there seem to be two interpretation of the fossil horizon as follows:

- a) The fossils are derived from a sandy facies of the Q<sub>3</sub> formation, which occasionally occur as the then channel fillings.
- b) The fossils come from the Q<sub>2</sub> formation which is often represented by sandy strata.

The authors have as yet insufficient data to decide this point.

Thick laterites are found only in a small area as a local phenomenon. They develop on the basement rocks and their surface is evidently higher than the Terrace III.

### 3. Southern Basin

The typical Southern Basin is represented by the spacious flat Bangkok Plain, where numerous distributaries develop, linked by many artificial canals. Big oxbow lakes are not common and no monadnocks are seen. The northern border of the Southern Basin may be drawn between Chainat (Loc. 5) and Sing Buri (Loc. 8).

In this region, outcrops sufficiently large to afford useful stratigraphic information are limited to the external north, and deep bore-holes provide the most important geological data. In Fig. 3-i, a schematic N-S geological profile parallel to the Mae Nam Chao Phraya is shown.



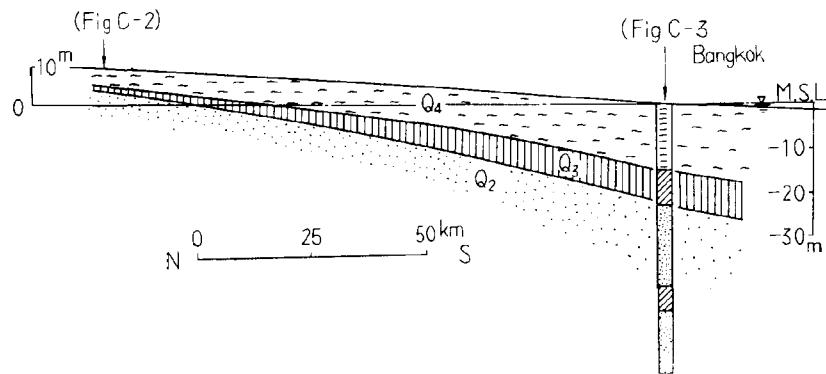
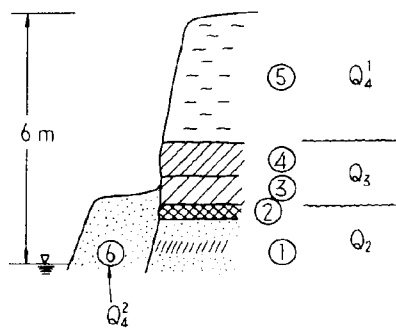

Fig. 3-i Schematic N-S profile parallel to the Mae Nam Chao Phraya



- (1) Heavily weathered alternation of clay and sand with large lime concretions ( $\phi$  10cm); olive gray with yellowish brown mottling .....(1.3m)
- (2) Light brownish gray sandy clay with abundant iron oxide concretions and in part with thin (5cm) layer of "laterite" .....(0.3m)
- (3) Sandy clay with pink quartz grains and numerous pisolitic iron oxide concretions. Clayey matrix is mottled in pale olive, light gray and light yellowish brown hues. ....(0.6m)
- (4) Brownish dark gray heavy clay. Pisolitic iron oxide concretions are rare. ....(0.9m)
- (5) Sandy loam; pinkish gray; homogeneous .....(2.8m)
- (6) Silty sand .....(2.0m)

Fig. 3-ii Section on the right bank of the Mae Nam Chao Phraya, 8 km north of Sing Buri (Loc. 8)

Near Sing Buri, the four geological bodies can be seen, which can readily be correlated with the  $Q_2$ ,  $Q_3$ ,  $Q_4^1$  and  $Q_4^2$  formations by their characteristic weathering pattern. The outcrop is shown in Fig. 3-ii.

Materials from drill cores at Siam Cement Co. Ltd<sup>8)</sup>, 20 km north of Bangkok, (Fig. 3-iii) falls into 3 categories:

- a) Shallower than 14 m;  
Clayey material characterized by no bearing capacity (N value=0)
- b) 14 m to 23 m;  
Clayey material of some bearing capacity (N value=9 to 14)  
Upper part is yellow and lower part is gray.

c) Deeper than 23 m ;  
 Sandy sediments  
 Further boring data at Krung Thep Bridge which are reported by Chai Muktabhant (1963)<sup>2)</sup> also indicate the occurrence of at least three kinds of sediments (Fig. 3-iv).  
 a<sup>1</sup>) Shallower than 16 m ;  
 Soft blue sandy clay  
 b<sup>1</sup>) 16 m to 20 m ;  
 Firm gray and brown plastic clay  
 c<sup>1</sup>) Deeper than 20 m ;  
 Stiff red and gray clay with laterite (?) and underlying sandy beds.  
 The formations (a) and (a<sup>1</sup>) both have no bearing capacity. On the criterion above they are provisionally equated and are apparently the youngest deposits in this area.  
 The N value of 9 to 14 in the (b) formation is a little bit too high for a normally consolidated clay of this depth. It means that this clay was formerly exposed to the open air and that the dewatering process has taken place. Yellow color of the (b) formation also appears to be a result of weathering. This fact implies that after deposition the clay has been subjected to weathering. It is conjectural that this event may correlate

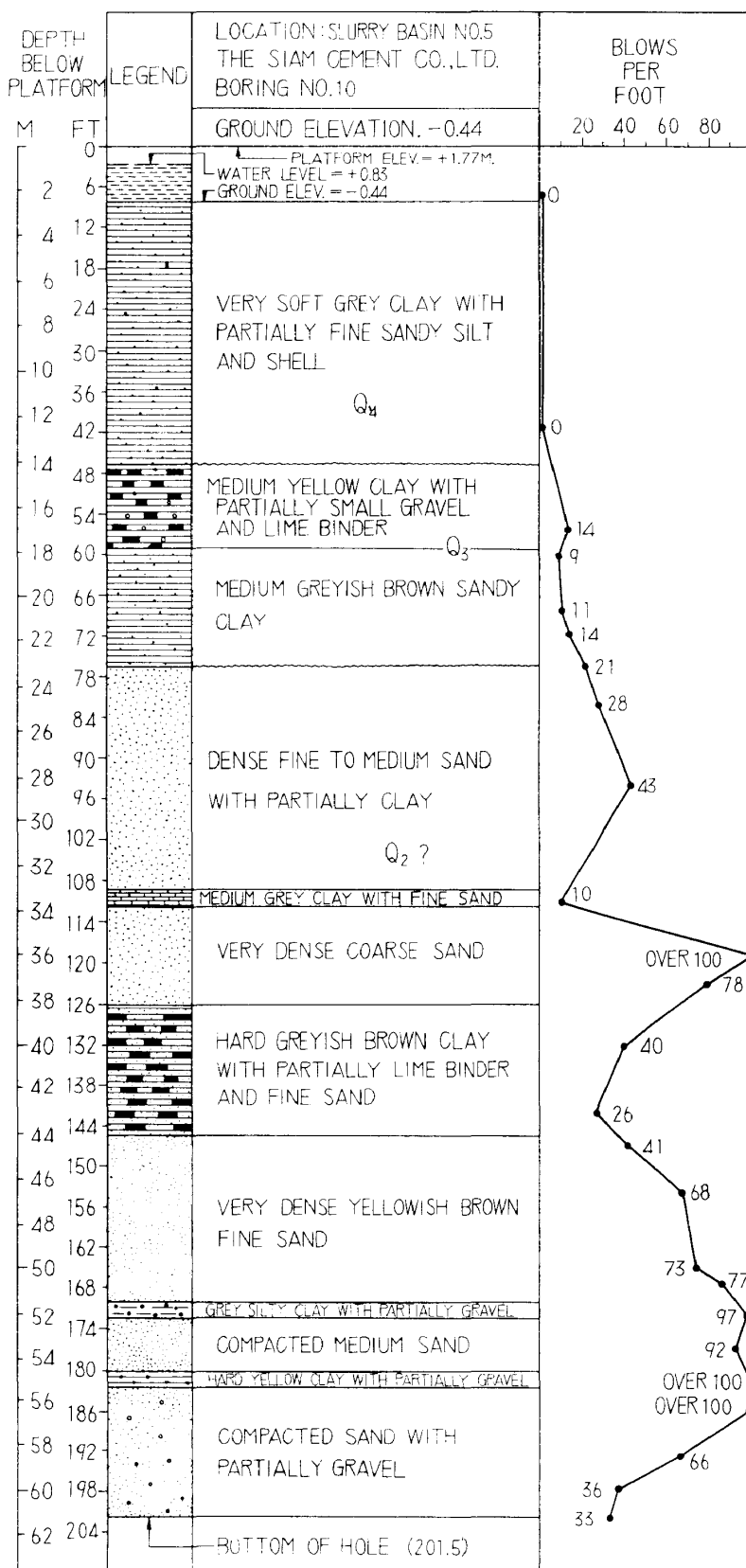

Fig. 3-iii Drill log at Siam Cement Co. Ltd.<sup>8)</sup>

with formation of the pisolitic concretion at Sing Buri (Loc 8). The available data are too scanty to elucidate the significance of the (c) and (c<sup>1</sup>) beds.

#### 4. Lop Buri—Sara Buri Area

The highway Route No. 1 passes through this area between Sara Buri (Loc. 11) and Takli (Loc. 6). Structurally this area is located at the eastern margin of the Chao Phraya depression, where the clastic Pleistocene sediments are thinning out and Paleozoic sedimentary rocks of the Rat Buri series appear in outcrop. Gently rolling topography of 60 to 80 m elevation assumed to be a dissected peneplain, is typical. In part this is interrupted by steep sided limestone monadnocks.

On the peneplain, no laterite can be found apart from one small outcrop south of Phra Phuttabat (Loc. 10).

Generally the surface consists of limestone of karst-like appearance. At some places heavily weathered white dyke rocks intrusive into the limestone are also seen.

Fig. 4-i shows a sketch of fluvial deposits found on this peneplain. The coarse material can be traced for 5 to 6 km in N-S direction and its distribution suggests an old stream course. The weathering features suggest that the sediments are Q<sub>2</sub> equivalents. However, for the exact correlation another field information should be sought.

The most interesting material in this area is the young calcareous deposits which skirt the peneplain.

The young calcareous deposits distributed in this area have the following

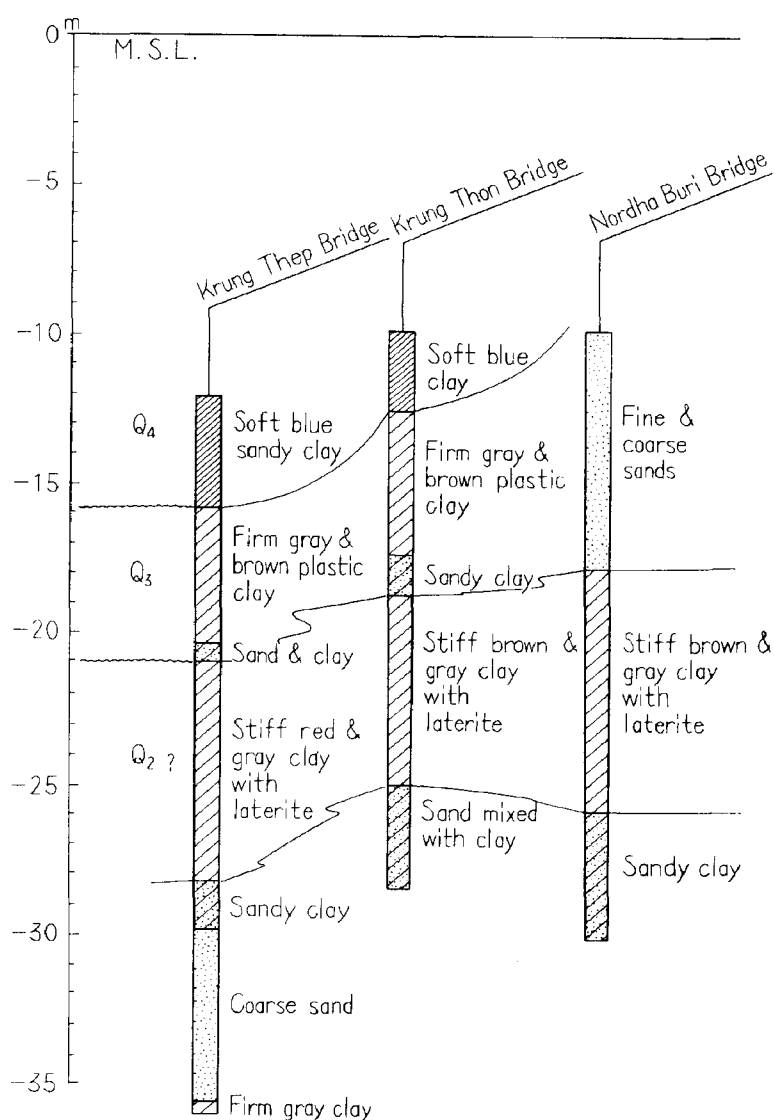
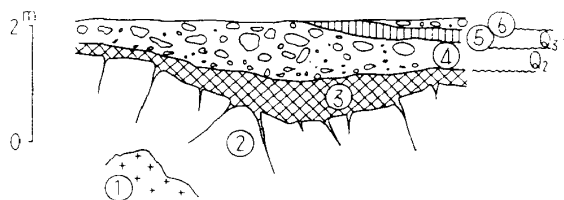

Fig. 3-iv Drilling columns in Bangkok area<sup>2)</sup> (Loc. 16)



- (1) Fresh Porphyrite
- (2) Heavily decomposed porphyrite; grayish white. Dark gray loamy material can be seen along joints, which develops from the surface of this decomposed porphyrite.
- (3) Mixture of light gray limy concretions ( $\phi$  0.2-0.3 cm) and dark gray loamy materials
- (4) Angular, subangular to subround gravels; 10cm in maximum diameter; 3-7cm in average diameter. These are composed of Mesozoic sandstones, conglomerates and shales, Paleozoic shales, sandstones, limestones and porphyrite. Some gravels are fresh, other decomposed. Partially cemented very compactly by the lateritic material.
- (5) Dark gray or black soil. Many plant roots are seen.
- (6) Removed gravels and black soil

**Fig. 4-i** Sketch of the fluvial deposits found near the 37 km milestone (Loc. 7) on the Highway No. 1 from Takli to Khok Samrong

characters :

- i) They are most pure calcium carbonate with scarce clayey material.
- ii) No coarse clastic grains are found.
- iii) Stratification is lacking.
- iv) No megafossils have been seen (microfossils are not yet checked).
- v) They have undulating surface of 15 to 30 m in elevation.
- vi) They are capped by black soil which is some 100 cm thick and contains pisolitic concretions of iron oxide. The boundary between the calcareous deposits and black soil is flatlying and rather sharp.
- vii) They are at least 10 m thick.
- viii) They extend for 50 km with NNW--SSE trend.
- ix) They are commonly overlain by the  $Q_3$  formation of Terrace II.
- x) Their distribution shows a close relationship with Paleozoic limestone.

The stratigraphical horizon and origin of the young calcareous deposits are unknown. Field relations indicate them to be older than the  $Q_3$  formation. However, so far, their direct relationship with the  $Q_2$  formation and the thickness have not been determined.

Dent and Mana Cheuthongdee (1966)<sup>3)</sup> suggested that old lakes in this area have been infilled by limy sediments. Their idea seems most probable, but non-fossiliferous unstratified deposits, 10 m thick, of wide distribution are not typical of ordinary lime deposits in the tropical region, which mostly contain abundant fossils. The microscopic investigation of these deposits is required.

### 5. Mae Klong Drainage

Physiographically the Mae Nam Mae Klong is independent of the Chao Phraya. In contrast with the Northern Basin and the Central Plain, this river occupies a rather restricted valley and has played only a subordinate role in developing of the big Central Valley.

The Quaternary sediments of the Mae Nam Mae Klong show a rather different characteristics. In this section, three outcrops will be described, one in the down-stream area, one typical of the middle course and the third from an intermountain basin.

Fig. 5-i shows the outcrop at the water reservoir construction site, 5 km SE of Kanchana Buri (Loc. 14), where the Mae Nam Mae Klong having passed through its mountainous part, deposits much of its load to form a part of big Central Valley. The topset dark brown loam (10) closely resembles the  $Q_4$  formation elsewhere in lithology. Underlying sandy silt (8) contains the typical iron oxide concretions. These features suggest the formation (10) to be equivalent to  $Q_4$  and (8) to the  $Q_3$  formation respectively.

The authors suppose a disconformity between sandy clay (7) and underlying sands with gravels (6). The indication of weathering characterized by the secondary clay minerals in the upper part of (3) seems to afford a good proof of the disconformity.

The lowermost clay (1) of 7 m thick has no weathering features but a sharp boundary and abrupt change from the 7 m clay (1) to gravelly part (2) is surely

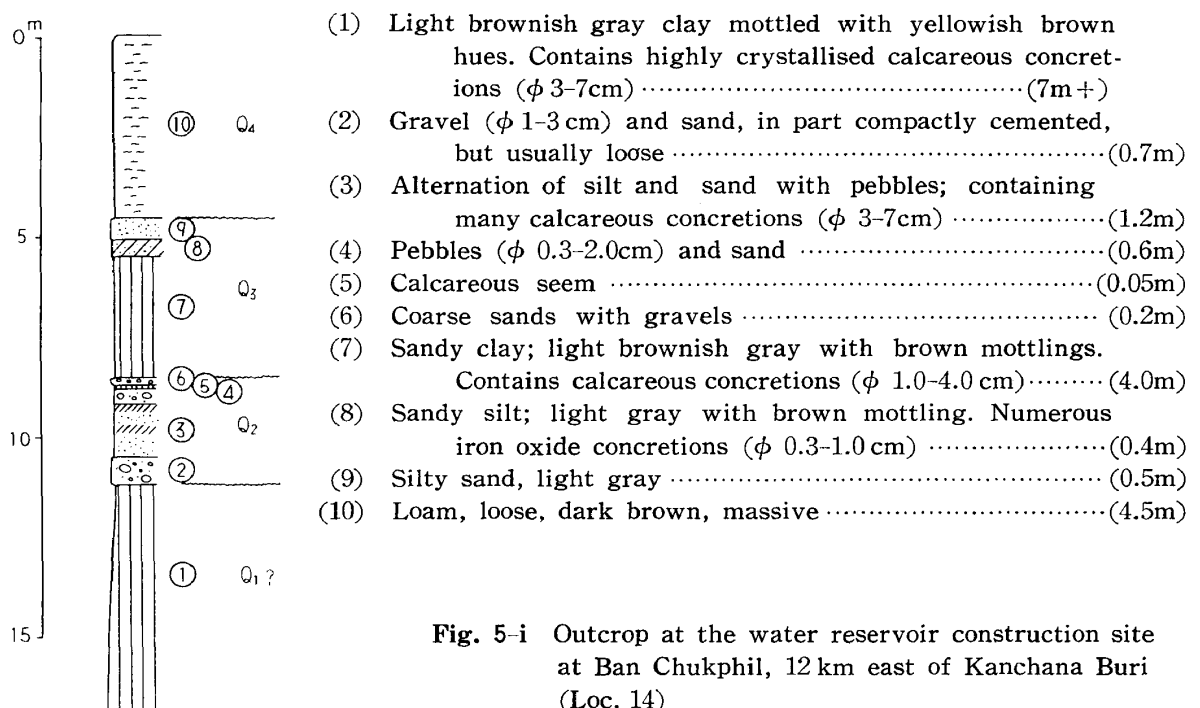

Fig. 5-i Outcrop at the water reservoir construction site at Ban Chukphil, 12 km east of Kanchana Buri (Loc. 14)

significant in terms of depositional history and changes in environmental condition. If the deductions made above are correct, conclusion should be made as shown in Fig. 5-i.

In the upstream area, near by Kanchana Buri, the Mae Klong parts into two big tributaries, the Kwaie Yai, and the Kwaie Noi. The sketch shown in Fig. 5-ii represents the situation in the mountain region at Ban Lat Ya (Loc.13), on the left bank of the Kwaie Yai, about 10 km NW of Kanchana Buri, where a small intermountain depression is located. Six physiographical units there form four terrace like surfaces.

In Fig. 5-ii, the Flood Plain and the Terrace I are apparently equivalent to those of the central depression of Thailand judging from their facies and position. The highest surface comprises a spacious peneplain of rolling topography recalling the peneplain in the Northern Basin, described above, though no laterite has yet been found here. Another three terrace-like surfaces developed between the Terrace

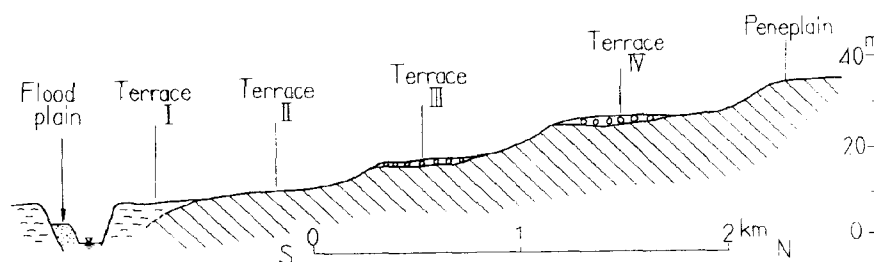

Fig. 5-ii Schematic cross section of Kwaie Yai valley, at Ban Lat Ya (Loc.13)

I and the Peneplain are named the Terrace II, the Terrace III, and the Terrace IV in ascending order. They have the following characters :

- a) Terrace II: No good exposure of alluvium has been yet found, though the sandy surface seems to indicate of sandy or gravelly deposits. The surface passes beneath the Terrace I without any steep slope.
- b) Terrace III: A thin layer of alluvium some 50 cm thick is composed of weathered gravels set in a red weathered fine-grained matrix. The surface is about 6 m higher than the Terrace II.
- c) Terrace IV: Alluvium less than 3 m thick is seen resting on an uneven basement. Strongly weathered gravels are cemented by lateritic material. The surface is about 10 m higher than the Terrace III and a rather steep slope links the Terraces IV and III.

The geological mode of these sediments is so different from the ordinary succession found in the Central Valley and at the water reservoir construction site that direct correlation is impossible. The only conclusion that can be drawn is

that the four terraces have possibly been formed subsequent to the development of the thick laterites in the Central Valley.

H. R. van Heekeren (1948)<sup>6)</sup> and K. G. Heider (1960)<sup>7)</sup> reported on pebble tools from Ban Kao (Loc.12), on the left bank of the Kwae Noi, 30 km west of Kanchana Buri. The authors discussed the shape of the tools and concluded that they were mostly Neolithic, some of them, Mesolithic and three pebble choppers were Lower Paleolithic.

The present authors visited the archeological site and constructed the geological cross section as shown in Fig. 5-iii.

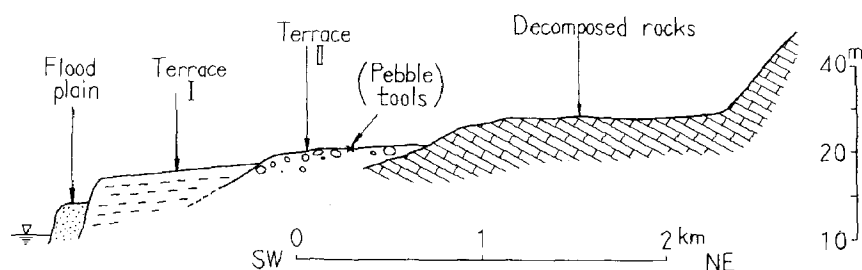

Fig. 5-iii Schematic cross section of the Kwae Yai valley, at Ban Kao (Loc.12)

Though the physiography seems to be similar to that of Ban Lat Ya, only two river terraces can be seen here. The Terrace I, which is composed of the dark brown loam is characteristic at this locality too. The Terrace II, whose surface disappears gently beneath the Terrace I, consists of slightly weathered gravels composed of round pebbles 3 to 7 cm in average diameter. The gravels are loosely cemented by sandy matrix, but the red soil and lateritic material which are the indicators of the Terraces III and IV can not be found. There is other higher surface here which might be correlated with the Terrace III or Terrace IV of Ban Lat Ya. However, we have no sufficient data to confirm or refuse this.

The old pebble tools are said to have been found on/or near the surface of the Terrace II. This fact is of considerable importance. Judging from the violent depositional environment of the gravels and well preserved worked surface on the tools, it seems to follow that the tools were introduced after the formation of the Terrace II.

On the other hand, considering the weathering feature and the stratigraphical relationships with the more older terraces, the age of the formation of the Terrace II is most likely to be an equivalent of  $Q_3$ , or at least younger than the  $Q_2$ . The authors consider that the age of the tools found on the Terrace II at Ban Kao would seem to be Mesolithic or Upper Paleolithic and there is no possibility of Lower Paleolithic in age.

#### IV. Some aspects of long-range correlation

Some similarity between Quaternary sections in the Central Thailand and the

Indian sequences can be recognized. Despite the scarcity of data, the definite stratigraphic position of the thick laterite seems to be traceable over wide areas. The stratigraphic level of this stratum in the Narmada valley (Central India) is more or less definitely of Lower Pleistocene or somewhat older. This age was established by De Terra and P. Teilhard De Chardin (1936)<sup>4)</sup> on the basis of paleontological data and by studying the direct relationship between the geological bodies in the Narmada valley. The thick laterites in the Central Thailand are located on the ancient peneplain just above the river terraces and also caps a rolling topography of 120 m in height in the Northern Basin. The peneplain is undoubtedly older than even the oldest terracic alluvium, which is more likely related to the Middle Pleistocene ( $Q_2$ ). The laterization probably occurred during the final stage of the peneplanation or a little later. It was probably simultaneous with the deposition of the alluvium of the higher terraces of the main rivers but did not extend up to Upper Pleistocene time. Under those circumstances, the geological age of thick laterites covering the remnants of the peneplain seems to be provisionally determined as Pliocene—Early Pleistocene and perhaps the lowest part of the Middle Pleistocene. If this idea is correct, it means that the thick laterites in Central Thailand correspond to the lateritic rocks of the same age in Narmada valley, Central India. The Pliocene—Early Pleistocene laterites are known also in Philippines. From a general point of view, these facts are important in making the stratigraphic correlation between Upper Cenozoic sequences of Southeast Asia. It also means that an important marking horizon at the uppermost part of the Pliocene and at the Early Pleistocene sequences must be established.

Another approach to the long-range correlation is the application of the fluctuations of sea level during the Pleistocene time. From this point of view, three columns shown in Fig. 3-iv are interesting. The lowest part of these columns consists of sands and sandy clays. The overlying stiff red, brown and gray clays with laterites are typical for all sections and may be considered as a marking horizon for the Quaternary sequences in the Bangkok area. Moreover, this horizon has some indications of weathering under the subaerial conditions. It means that this horizon reflects the presence of an ancient topography and there is interruption in deposition between it and the overlying sands or sandy clays. The upper contact of the clays with laterite is 18 to 28 m below sea level and covered by younger sands and clay. The development of the subaerial weathering and laterization in this horizon indicates the lower position of the sea level. These strata seem to be related to the regressive stage of the ocean. In view of the scarcity of data it is difficult to say the geological age of this horizon. Two versions could be suggested. One is that these deposits correspond to the Late Pleistocene, and the other to the Middle Pleistocene. The second version seems to be more likely.



Anyway it is clear that there are not sufficient data for more definite age determination.

The evidence of the regression also seems to correspond to the bottom topography, recorded on the Sarawak Shelf where a Proto-Lupar submarine valley has been recognized (Haile, Keij and Pimm, 1964)<sup>5)</sup>. The depth of its ancient channel, according to systematic survey data, does not exceed 170 m and usually is 110 to 140 m. The depth of the shelf surface surrounding the channel is about 60 to 65 m. It is interesting to notice that currently accepted estimates of Pleistocene sea level lowering during the last 200,000 years are 90 to 110 m. In the Proto-Lupar submarine channel, according to the report of Haile, Keij and Pimm (1964), the soft recent clay is underlain by firm clay which may be older than recent, and ironstone nodules are abundant.

These data are important from the view point of the wide correlation of the Pleistocene deposits. Taking into account some difficulties in the application of paleontological data for the stratigraphical subdivision of the Quaternary deposits in the tropical area, the study of the fluctuation of the sea level and the peculiarities of the bottom topography, particularly in the offshore areas, may become a principal method of long-range correlation.

The study of the Upper Cenozoic deposits and particularly their stratigraphic subdivision in Southeast Asia, will be not complete if the main valleys developed over a long period of geological time are not investigated. With respect to Indochina, the valley of the Mekong is one of the most important places where the key section of the Upper Cenozoic deposits may be compiled.

## V. Summary and recommendations

The stratigraphic columns which have been observed during the course of this survey are summarized in Table 1, where provisional correlations are also made. Unfortunately the lack of paleontological information at present available does not permit of precise and detailed correlation of these various sections. Correlation is therefore made here mainly on the basis of erosional surfaces, developed at time when sedimentation was interrupted. The geomorphological elements and lithological characters of sediments also have been used.

It is recommended that future efforts be directed towards obtaining paleontological data. The working out of the stratotypical sections founded with complete geological information is one of the most important points for the following survey in this area. It is considered that the young calcareous deposits underlying the  $Q_3$  formation are of fundamental importance amongst the unconsolidated deposits of this area. It is further considered that the Bangkok Plain

Table. 1 Provisional correlation chart of Quaternary deposits in Central Thailand

Chrono Stratigraphic Units	Index	SURVEYED AREAS						
		Northern Basin	Nakhon Sawan Area	Southern Basin (Bangkok Plain)	Eastern Margin Area	Mae Klong Drainage		
						Mae Klong Basin	Kwae Yai Valley	Kwae Noi Valley
HOLOCENE	Q <sub>4</sub>	Alluvium of Flood Plain with "Sawankalok earthenware"	Loamy or sandy Alluvium of Flood Plain	Soft blue sandy clay, silt and fine sand	Alluvium of Flood Plain	Alluvium of Flood Plain	Loamy or sandy alluvium of Flood Plain	Alluvium of Flood Plain
		Loamy alluvium of Terrace I	Loamy alluvium of Terrace I		Black soil	Loamy alluvium of Terrace I	Loamy alluvium of Terrace I	Loamy alluvium of Terrace I (Pebble-tools) (on Terrace II)
	Q <sub>3</sub>	Alluvium of Terrace II with pisolithic concretions	Clayey deposits of Terrace II with pisolithic concretions	Firm gray and brown plastic clay		Clayey deposits with pisolithic concretions	Surface of Terrace II	Gravel of Terrace III
PLEISTOCENE	Q <sub>2</sub>	(weathering of surface of Terrace III)	(weathering of surface of Terrace III)	(sand)		(weathering)	(weathering)	(weathering)
		Sandy alluvium of Terrace III	Sandy alluvium of Terrace III with remains of <i>Hippopotamus</i> , <i>Stegodon</i> and <i>Bubalus</i>	Stiff red and gray clay with laterite		Loosely cemented sand, clay and gravel with calcareous concretions	Alluvium of Terrace III	Terrace-like surface
QUATERNARY	Q <sub>1</sub>	Thin laterites developed upon remnants of Peneplains		coarse sand	Loose calcareous non-stratified sediments	(erosion)	Laterized alluvium of Terrace IV (erosion)	
						Clay with calcareous concretions	Peneplanation (?) and weathering	
NEOGENE	N <sub>2</sub> <sup>2</sup>							

Alekssev and Takaya : Upper Cenozoic Deposits in the Chao Phraya Basin

is the area most likely to furnish an complete Tertiary and Quaternary succession in the Southeastern Asian region, and to this reason the bore-hole data are urgently required.

The study of the Tertiary and the Quaternary sedimentation is important for the economic geology of Thailand, particularly as the maintenance of the mineral and fuel resources in this country are at present derived from the deposits of this age. The primary task would therefore be to work out a key stratigraphic section, which would form the basis of subsequent geological studies and prospecting operations.

### References

- 1) Brown, G.F., S. Buravas, N. Charaljavanaphet, W.D. Johnston, V. Sresthaputra and G. Taylor. "Geologic Reconnaissance of the Mineral Deposits of Thailand," *U.S. Geological Survey Bulletin*, No. 984. 183p. 1951.
- 2) Chai Muktabhant. "Mimeograph prepared for the conference on architecture and structural engineering in relation to the construction of large buildings," Bangkok, 1963.
- 3) Dent, F.J. and Mana Cheuthongdee. "Soil series survey of the MERS Lop Buri study area," (mimeograph) Ministry of National Development, Thailand, 1966.
- 4) De Terra H. and De Chardin T. "Observations on the Upper Siwalik formation and later Pleistocene deposits in India," *Proc. Amer. Phil. Soc.*, No. 76, pp. 791-822. 1936.
- 5) Haile, N.S., A.J. Keij and A.C. Pimm. "Preliminary report on the oceanographic cruise of H.M.S. Dampier in the South China Sea," *Annual report of the Geol. Survey, Borneo Region, Malaysia, 1963*. pp. 119-141. 1963.
- 6) Heekeren, H.R. van. "Prehistoric discoveries in Siam, 1934-1944," *Proc. of the Prehistoric Society*, No. 14, pp. 24-32. 1948.
- 7) Heider, K.G. "A pebble-tool complex in Thailand," *Asian Perspectives*, No. 2, pp. 63-67. 1960.
- 8) K. Engineering Consultant Co. Ltd. "Soil investigation for the Siam Cement Co. Ltd." (mimeograph)
- 9) Koenigswald, von G.H.R. "A mastodon and other fossil mammals from Thailand," *Report of investigation*, No. 2, pp. 25-28. Royal Department of Mines, Thailand, 1959.