

Saline Soils in Northeast Thailand

Their Possible Origin as Deduced from Field Evidence

by

Somsri SINANUWONG* and Yoshikazu TAKAYA**

Abstract

The selected profiles of saline soils in the vicinity of Khorat, Northeast Thailand, are described. Geomorphological interpretation of the profiles make the following points clear regarding the origin of the salt:

- 1) Some shales and sandstones belonging to the Mahasarakam Formation of the Mesozoic Khorat Group retain in-situ salt even when they are located as little as 1 to 2 m below the ground surface. The salt is released by erosion and weathering. This is the mechanism of extraction of salt from the source rock.
- 2) Only the Mahasarakam Formation seems to be a source of salt. Other rocks, including the older formations of the Khorat Group, appear not to contribute the development of salinity in the area, because they do not contain salt.

I Geological Setting

Precipitation of salt on the ground surface of Northeast Thailand during the dry season has long been known. The extensive development of rock salt in the ground at depths below 60 m was found by deep drillings in the 1950's. The rock salt beds are interpreted by geologists to belong to the middle to lower horizons of the Mahasarakam Formation of the Mesozoic Khorat Group.

Since the distribution of salt on the ground surface and the rock salt beds themselves show good correspondence, it has often been suggested that the surface salinity originates from the rock salt beds. This is not convincing, however, because from the hydrological viewpoint the vertical migration of brine by the order of 60 m from the rock salt beds to the ground surface is unlikely, if not impossible.

If the rock salt beds are not the primal source of the salt, there must be other geological body or bodies capable of releasing salt, to explain the surface salinity found in certain areas. The author's working hypothesis was that the so-called salt-free portion of the Mahasarakam Formation, which coincides with the upper horizon of the same formation, could be the possible source. The field survey was thus concentrated on the study of chloride content

* Department of Land Development, Thailand

** 高谷好一, The Center for Southeast Asian Studies, Kyoto University

in the so-called salt-free portion of the Mahasarakam Formation.

The results show that the so-called salt-free portion of the Mahasarakam is in fact salt-impregnated.

II Description of Profiles

i) Illustration by cross sections

The field occurrences of the salinity are illustrated by two cross sections, one linking Khorat and Ban Kham (Figs. 9 and 10) and the other along the Non Thai-Chaibadan highway (Figs. 16 and 17). The cross sections have 14 and 13 sampling sites respectively, whose detailed descriptions are given separately.

ii) Determination of chloride contents

The determinations of the chloride contents of specimens was made in the field under the following method;

1. put ca. 5 cc of distilled water in a test tube
2. add one drop of 0.1 N silver nitrate
3. soak a piece of the specimen of ca. $0.3 \times 0.3 \times 0.3$ cm³, whose surfaces are freshly trimmed.

The content of chloride was studied quantitatively. The visible amount of white silver chloride precipitate was observed with the naked eye and the degree of the reaction to the silver nitrate was thereby rated into such classes as nil, very weak, weak, moderate and strong.

iii) Ground height

No special survey was made for determining the elevation of locality, so the height recorded here is no more accurate than can be assessed from the 1 : 50,000 topographical map of series L-708.

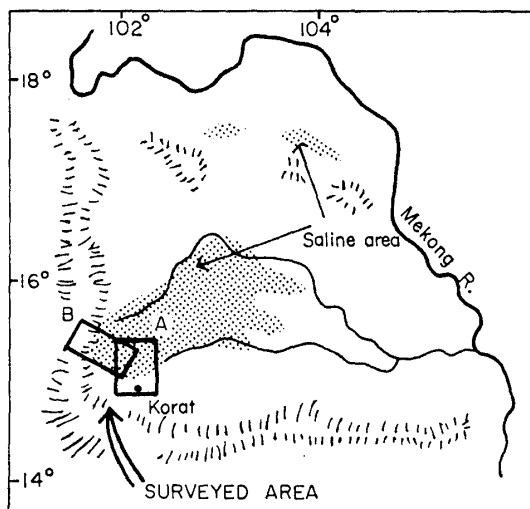

Fig. 1 Index map showing the surveyed area

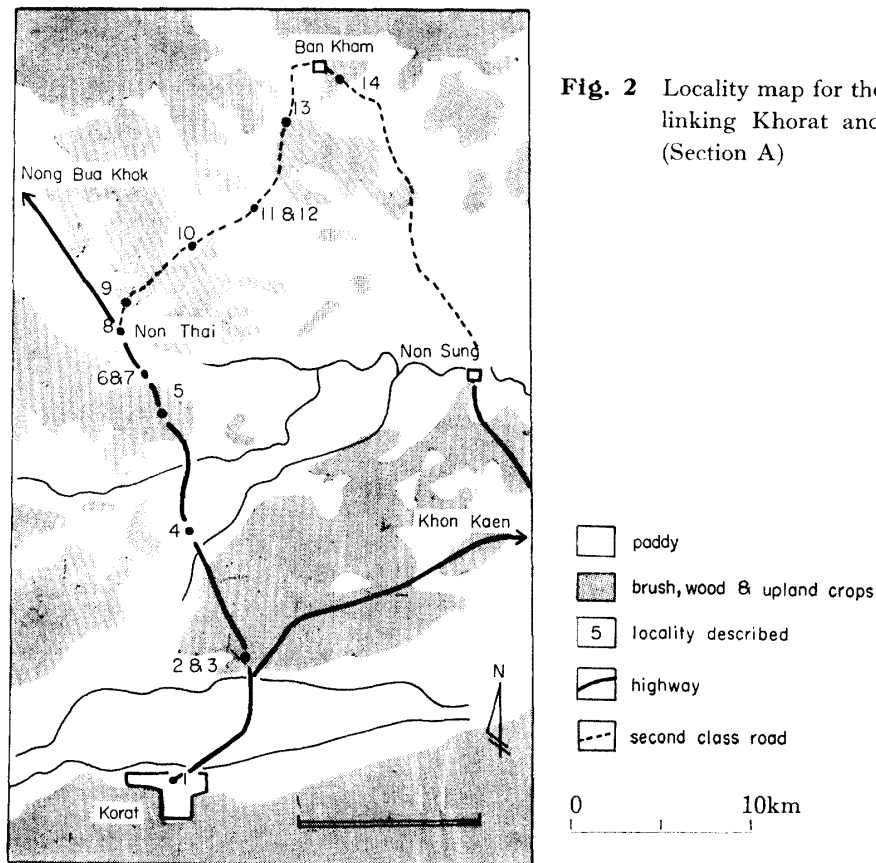

Fig. 2 Locality map for the cross section linking Khorat and Ban Kham (Section A)

iv) Abbreviation

The following abbreviations are used in the descriptions.

(color)	yellow: yl	brown: br
	gray: gr	white: wh
	red: rd	
(texture)	heavy: H	light: Li
	clay: C	loam: L
	sand: S	
(reaction)	Reaction: R	very: v
	weak: we	moderate: md
	strong: st	
(others)	calcareous: Ca	manganese: Mn
	iron: Fe	ground height: G.H.

v) Description of profiles along cross section A

Loc. 1 Changwat office of Nakhon Ratchasima

According to local people, most of shallow wells in the northern half of the city produce saline water while those in the southern half fresh water

Locs. 2 & 3 Ban Choho, ca. 9.0 km N of Khorat along the Khorat-Non Thai Hwy.

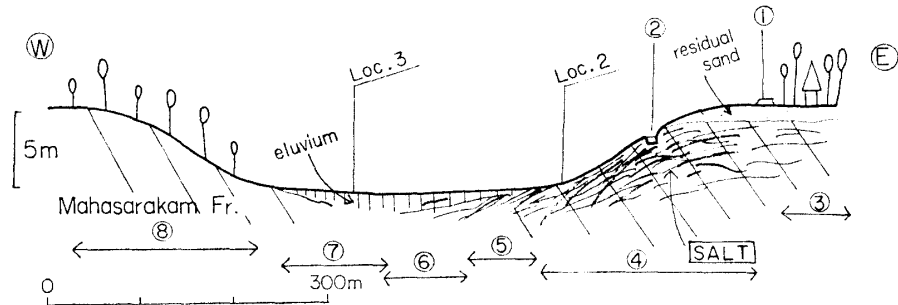

Fig. 3 An E-W cross section through Locs. 2 & 3

G.H.: 175 m (loc. 2)

- 1) Khorat-Non Thai Hwy
- 2) pond, $20 \times 30 \text{ m}^2$; water shows md R
- 3) house compound with many garden trees
- 4) bush covered slope with many halophytic bushes such as *Nam deang*, *Nam prom* and *Nam phi*; salt crusts are ubiquitous in and along wadi-like scars
- 5) paddy fields with rice plants 140 to 160 cm tall
- 6) water logging paddy fields with rice plants 160 to 170 cm tall
- 7) similar to (5)
- 8) bush and wood covered hillock

Auger hole (Loc. 2)

- 0.0-0.2 m : S; md to st R
- 0.4 m : SC; we R
- 0.6 m : do; we R
- 0.8 m : do; we to md R
- 1.0 m : do; we R

Auger hole (Loc. 3)

- 0.0-0.2 m : LiC; v v we R
- 0.4 m : do; no R
- 0.6 m : do; no R
- 0.8 m : do; no R
- 1.0 m : do; no R
- 1.2 m : do; no R

Loc. 4 14.8 km N of Khorat along the Khorat-Non Thai Hwy

Ground surface: flat and spacious paddy fields; 70% transplanted, 25% unplanted because of shortage of water and 5% broadcasted. G.H.: 168 m

Auger hole (Loc. 4)

- 0.0-0.2 m: Li gr SC with br mottlings; we R
- 0.4 m: gr C; we to md R

- 0.6 m: do; we R
- 0.8 m: gr HC with br yl mottling; we R
- 1.0 m: do but with profuse br yl mottlings; v we R

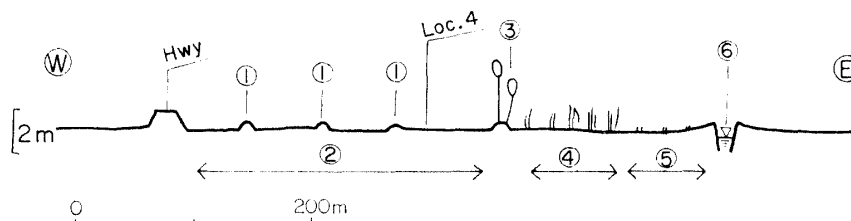

Fig. 4 An E-W cross section through Loc. 4

- 1) clumps of *Nam daeng*, *Nam phi* and *Nam prom*
- 2) unplanted rice fields; many parts are covered by dried up algae (see Fig. 5)
- 3) clumps of *Sakae* (*Combretum quadrangulare*)
- 4) *Scirpus* marsh
- 5) transplanted rice fields, partly water logging
- 6) creek ca. 10 m wide, 0.5 m in bank height: water shows md R

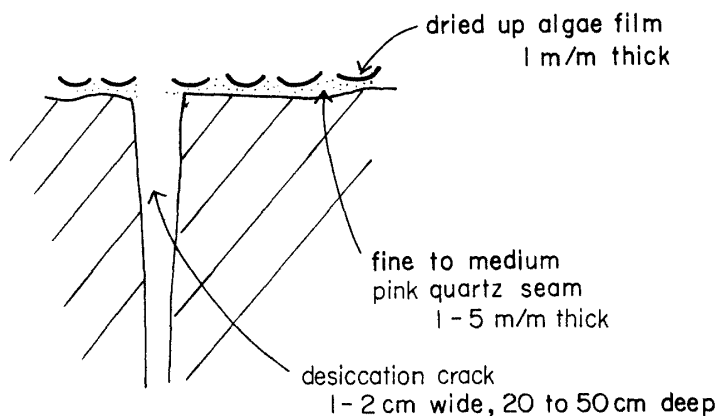

Fig. 5 A close-up view of a salt crust near Loc. 4.

Salt crust often develops with the sand seams like those shown here.

Loc. 5 Ban Don, ca. 6 km S of Amphoe Non Thai along the Khorat-Non Thai Hwy
 Surface: undulating hill top, covered by garden trees such as kapok jackfruit, mango and bamboo. G.H.: ca. 185 m

0.0-2.0 m: non-bedded homogeneous fine to medium S; no R

Locs. 6 & 7 Ban Hua Nong, 3.5 m S of Amphoe Non Thai along the Khorat-Non Thai Hwy. G.H.: ca. 170 m

Auger hole (Loc. 6)

Surface: rice field with common trees and bushes including *Nam daeng*; no salt crust

0.0-0.2 m: fine to medium S with profuse pink quartz; we R

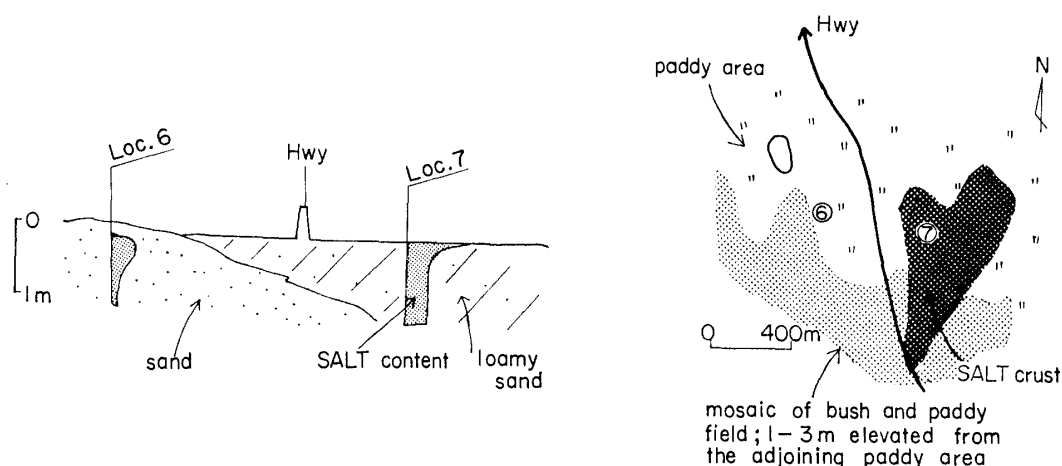

Fig. 6 The variation of salt content within a short distance

- 0.4 m: S, but slightly clayey; v we R
- 0.6 m: S with common yl cloudy mottlings; v we R
- 0.8 m: S with few yl cloudy mottlings and very few Mn-pisoliths (ϕ 3 m/m);
v we R
- 1.0 m: S with many Ca-nodules and common yl mottlings; v we R

Auger hole (Loc. 7)

Surface: paddy fields with salt crusts; palmyra palm, *Nam daeng*, *Nam phi* and *Sakae* are common

- 0.0-0.2 m: gr LS; we to md R
- 0.4 m: do; we to md R
- 0.6 m: do; we to md R
- 0.8 m: gr S; we to md R
- 1.0 m: do; we to md R

Loc. 8 Amphoe non Thai (ca. 29 km N of Khorat)

Surface: A large pond (more than 1 ha) in front of the bus terminal, whose water level is 1 to 2 m higher than the adjoining paddy fields. G.H.: ca. 172 m

Water: md R

Loc. 9 2 km N of Amphoe Non Thai along the Non Thai-Ban Kham Rd

Surface: a shallow erosional valley of the Huai San Thia (50 m wide and 1 m in bank height) formed in the Mahasarakam Formation; very slightly undulating paddy fields with many patches of saline crusts; halophytic bushes such as *Nam daeng* and *Nam prom* are common. G.H.: ca. 169 m

Loc. 10 Ban Non Phutsa: ca. 8 km N of Amphoe Non Thai along the Non Thai-Ban Kham Rd

Surface: slightly undulating paddy fields with many trees such as *Sakae* (*Combretum*

quadrangulare), *Khoi* (*Streblus asper*) and *Putsa* (*Zizyphus*). G.H.: ca. 167 m

Auger hole

0.0–0.2 m: compact, dark br LS; no R

–0.4 m: compact, yl br SL; no R

–0.6 m: compact; br L with many fine (1 m/m) Fe- and Mn- concretions; no R

–0.8 m: do; no R

–1.0 m: accumulation of Ca-nolules; no R

Locs. 11 and 12 Ban Thanon Pho; ca. 11 km N of Amphoe Non Thai along the Non Thai-Ban Kha Rd

Surface: very slightly undulating paddy fields with salt crusts; the margining zone between a hillock (3 to 4 m high) and an eluvial valley G.H.: ca. 167 m

Fig. 7 A tongue-shaped salt crust extending from a hillock

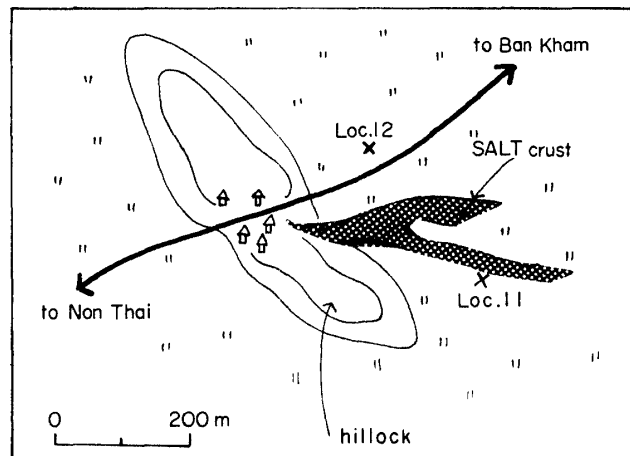

Auger hole (loc. 11)

0.0–0.2 m: light br gr C with br fibrous mottlings; v we R

–0.4 m: light gr L; v we R

–0.6 m: gr LiC; we to md R

–0.8 m: light gr C with few to common br mottlings; we R

–1.0 m: gr LiC with profuse yl mottlings and common Mn-concretion (ϕ 0.2–1.0 cm); we to md R

Loc. 12 Same as Loc. 11

A dug pond (20 × 20 m², 1 m deep) whose water level is nearly same as the ground surface of the adjoining paddy field.

Water; no R

Red sandstone and loam which are dug out from the pond floor show no R

Loc. 13 Ban Don Yai, ca. 19 km N of Non Thai along the Non Thai-Ban Kham Rd

Surface: very slightly undulating paddy fields with few to common (50–150 m interval)

standing trees. G.H.: ca. 176 m; saline crusts are occasionally found.

Outcrop along the road

0.0–0.3 m: yl gr S; md R

–0.5 m: dark gr compact C; md R

–1.0 m: br gr S; md R

–1.6 m: dark gr CS with few Ca-nest; md R

Loc. 14 Ban Nong Samrong; 2.5 km S of King Amphoe Ban Kham along the Ban Kham-Non Sung

Surface: slightly undulating kenaf fields with few paddy fields in lower positions. G.H.: ca. 177 m

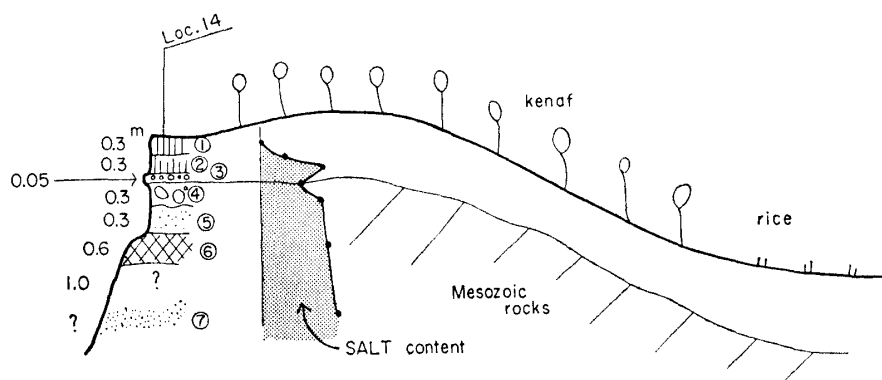

Fig. 8 Shale and sandstone of the Mahasarakam Formation, which locate ca. 2 m below the ground surface, retain rich salt

1) very dark br gr HC; no R

2) do, but lighter in color; we to st R

3) accumulation of Mn-pisoliths

4) kaolinic layer with profuse Ca-nodules; md to st R

5) white C with common rd concretions and common Ca-nolules; md to st R

6) rd gr shale with wh strips; md to st R

7) br sandstone; st R

vi) Description of cross section A

a) A hill composed of the Khok Kruat Formation; salt free

b) A low hill or terrace underlain by the Mahasarakam Formation. The border between (a) and (b) is supposed to extend in east-west direction judging from the distribution of salt and fresh water wells

c) The alluvial valley of the Lam Khlong Boribun and Lam Takhlong; salt carried in and distributed by the streams and other minor creeks form patches of salt crusts in places

d) A Mesozoic hill; the near-surface layer 1 to 2 m thick is usually covered by loose

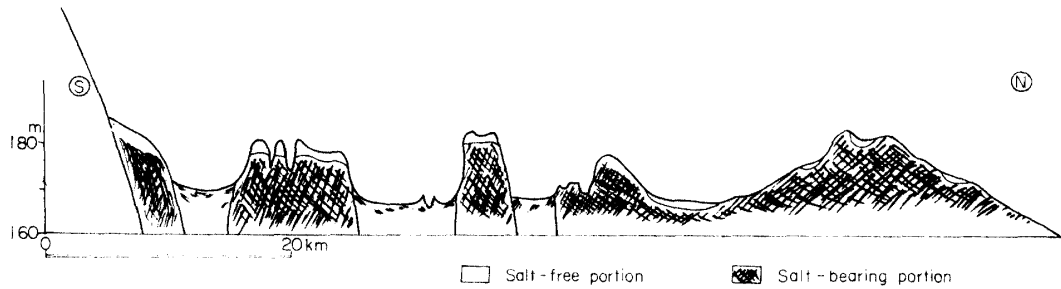

Fig. 9 The cross section, between Khorat and Ban Kham, showing the possible distribution of salt

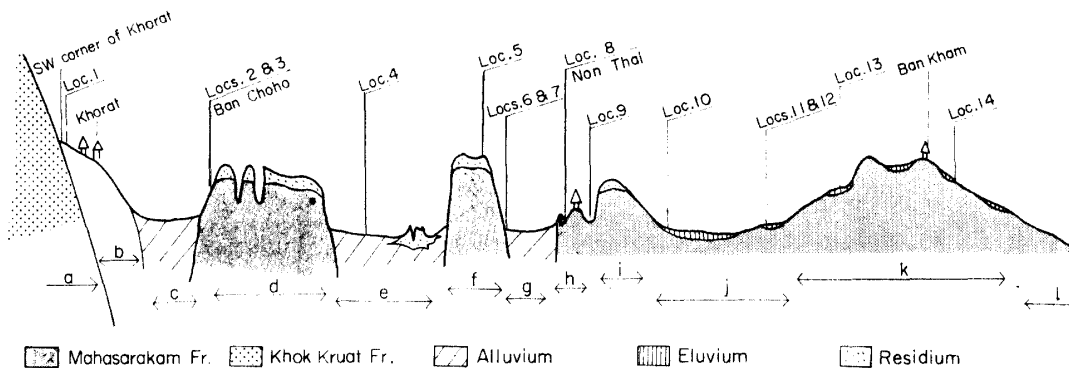

Fig. 10 The cross section between Khorat and Ban Kham, showing geomorphologic structure

sand and salt free, while the deeper portion which is composed of Mesozoic shale and sandstone most probably retains salt

- e) The alluvial valley of the Lam Chiang Krai; Salt carried in by alluviation is rich throughout the valley; mostly covered by paddy fields, but locally covered by saline waste and Scirpus marsh like at Loc. 4
- f) A Mesozoic hill; similar to (d)
- g) A shallow alluvial valley of the Huai Tha Khae; similar to (e)
- h) A Mesozoic hillock with very thin sandy surface layers: The extension of the saline Mesozoic rocks near the ground surface is suggested by the high chloride content of the water in a pond (Loc. 8) which is dug on the hillock
- i) A Mesozoic hill; a part of this is covered by sandy top layers but other part is covered by red-colored latosol-like clayey layers
- j) A shallow eluvial valley engraved in the Mahasarakam Formation; the near-surface layer 0.3 to 2.0 m is covered by varying eluvial materials ranging from sand and loam (like at Loc. 11) to grumsolic (?) clayey soils (like at Loc. 10): Some parts are strongly salt-affected (as in Loc. 11) but others are salt free (as in Loc. 10)
- k) A swelly part of the Mahasarakam Formation area; though eluvium develops locally, they are usually thin: Rocks of the Mahasarakam Formation crop out or locate very near to the ground surface and some of them occasionally retain rich

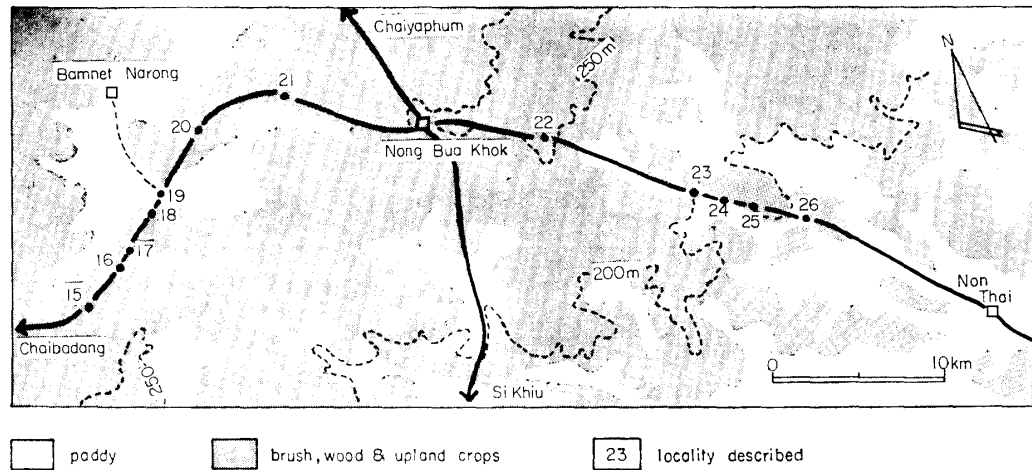

Fig. 11 Locality map for the cross section along the Non Thai-Chaibadan highway (Section B)

in-situ salt (like at Loc. 14)

l) A swaly portion of Mesozoic terrain with eluvial materials; similar to (j)

vii) Description of profiles along cross section B

Loc. 15 Ban Khok Hin Tang; 7.7 km SW of the T-junction between the Bamnet Narong Rd and the Non Thai-Chaibadan Hwy

Surface: slightly undulating wood land. G.H.: ca. 230 m

0.0–1.0 m: slightly weathered br rd shale; no R

Loc. 16 1 km S of Ban Kut Talat; 4.7 km SW of the T-junction between the Bamnet Narong Rd and the Non Thai-Chaibadan Hwy

Surface: slightly undulating kenaf fields. G.H.: ca. 225 m

Auger hole

0.0–0.2 m: gr br v fine S; no R

–0.4 m: yl br v fine S; no R

–0.6 m: light br LS; no R

–0.8 m: do, but slightly more reddish; no R

–1.0 m: do; no R

Water in a pond (60×120 m²) located near by shows v v v we R

Loc. 17 1 km NE of Loc. 16 along the Non Thai-Chaibadan Hwy

Surface: slightly undulating bush land with few paddy patches in swales. G.H.: ca. 220 m

An outcrop on the bank of a pond (50×150 m²)

0.0–0.7 m: slightly indurated pink quartz S; no R

–0.8 m: Accumulation of Mn-pisoliths; no R

–1.1 m: slightly indulated pink quartz sand; no R

–1.5 m: yl gr and br mixed weathered shale; mostly no R but partly v v v we R

Water in the pond; v v v we R

Loc. 18 1.5 km SW of the T-junction between the Bamnet Narong Rd and the Non Thai-Chaibadan Hwy

Surface: swampy rice field. G.H.: ca. 209 m

Auger hole

0.0–0.2 m: br gr fine S; no R

–0.4 m: dark gr laminated fine S with LiC and peat; v we R

–0.8 m: light gr C with few Mn-pisoliths; v v we R

–0.8 m: gr CL with common Mn-pisoliths; v v we R

–1.0 m: do; v v we R

Loc. 19 The T-junction between the Bamnet Narong Rd and Non Thai-Chaibadan Hwy

Surface: Khlong Lam Ping and its brush covered levee. G.H.: ca. 209 m

1) Water; md R

2) yl gr tream sand; we R

3) levee; no R

4) bluish gr shale; md R

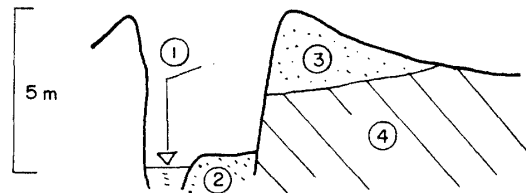

Fig. 12 The outcrop of Loc. 19

Loc. 20 Ban Khok, 4.5 km NE of the T-junction between the Bamnet Narong Rd and the Non Thai-Chaibadan Hwy

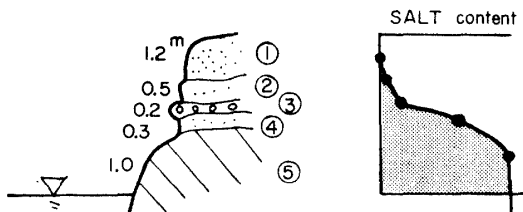

Fig. 13 The outcrop of Loc. 20. Gray colored shale of the Mahasarakam Formation retains rich salt

Surface: a quarry in slightly undulating bush land with kenaf fields. G.H.: ca. 208 m

1) light br gr v fine S; no R

2) compact CS; v v v we R

3) Accumulation of Mn-pisoliths; v we R

4) compact gr clayey S with many Fe- and Mn-pisoliths and few Ca-nodules (ϕ up to 3 cm); md R

5) gr shale; st R

Loc. 21 ca. 9 km NW of Bun Nong Bua Khok along the Non Thai-Chaibadan Hwy

Surface: an outcrop at a quarry for road gravel, in sloping and undulating bush land.

G.H.: ca. 210 m

1) dark br gr HC with Ca-nodules (grumsolic ?); no R

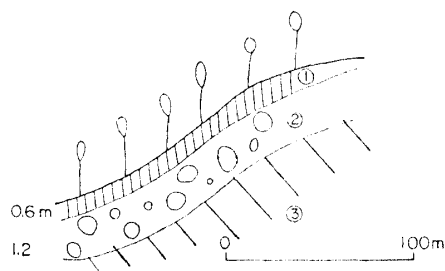

Fig. 14 The sketch of Loc. 21

- 2) Mixture of Ca-nodules, shale fragments, Mn-pisoliths and kaolinic clay: only shale fragments show v v we R, others not
- 3) rd siltstone; md R

Loc. 22 ca. 8 km SE of Ban Nong Bua Khok along the Non Thai-Chaibadan Hwy
 A pond dug on slightly undulating bush land with few paddy and kenaf fields. G.H.: ca. 250 m
 Water; no R

Loc. 23 ca. 19.5km NW of Amphoe Non Thai along the Non Thai-Chaibadan Hwy
 Surface: undulating bush land with few paddy patches in swaly position. G.H.: ca. 200 m
 Small salt crusts are in paddy fields

Loc. 24 Ban Pakham; 2 km SE of Loc. 9 along the Non Thai-Chaibadan Hwy
 Surface: a large salt crust on very slightly undulating paddy fields. G.H.: ca. 190 m
 Auger hole

- 0.0-0.2 m: pinkish gr S; md to st R
- 0.4 m: yl and pink mixed S; we to md R
- 0.6 m: gr coarse S; we to md R
- 0.8 m: light pink S; we to md R

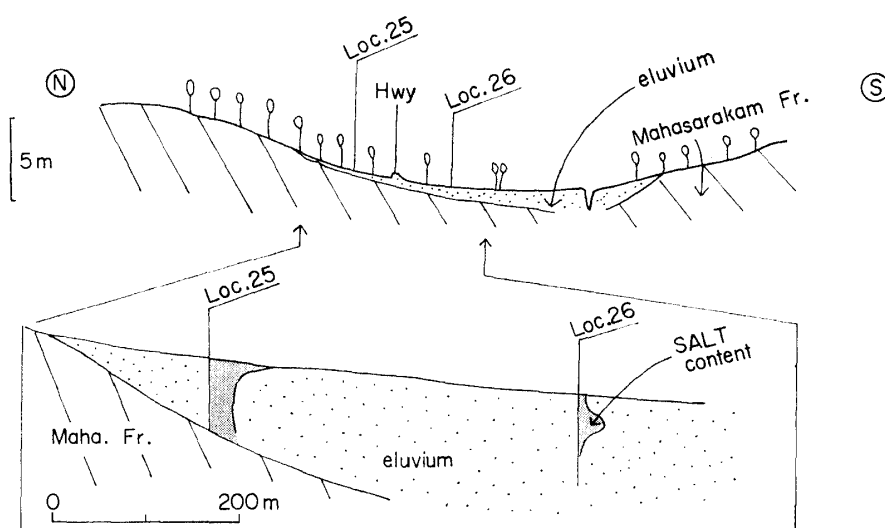

Fig. 15 The variation of salt content in eluvium

Locs. 25 & 26 15 km NW of Amphoe Non Thai along the Non Thai-Chaibadan Hwy

Surface: a shallow eluvial valley in the Maharakam Formation

Auger hole (Loc. 25: swampy brush land surrounded by paddy fields. G.H.: ca. 186 m)

0.0–0.2 m: laminated layers of black C and pink quartz S; md R

–0.4 m: do; md R

–0.6 m: gr S with thin dark gr C seams; we to md R

–0.7 m: gr S; we to md R

0.7– : accumulation of Ca-nodules

Auger hole (Loc. 26: paddy field with few bush clumps. G.H.: ca. 185 m)

0.0–0.2 m: br gr S; v we to we R

–0.4 m: br gr SL; we R

–0.6 m: yl gr L; v we R

–0.8 m: do; v we R

–1.0 m: yl gr S with common Mn-concretions; v v v we R

–1.2 m: do; v v v we R

Loc. 27 Ban Bung Noi; 9.5 km NW of Amphoe Non Thai along the Non Thai-Chaibadan Hwy

Surface: a quarry in bush land. G.H.: ca. 185 m

0.0–0.4 m: dark br gr C (grumsolic ?); no R

0.0–1.1 m: mixture of Ca-nodules and rd sandstone fragments; partly we to st R

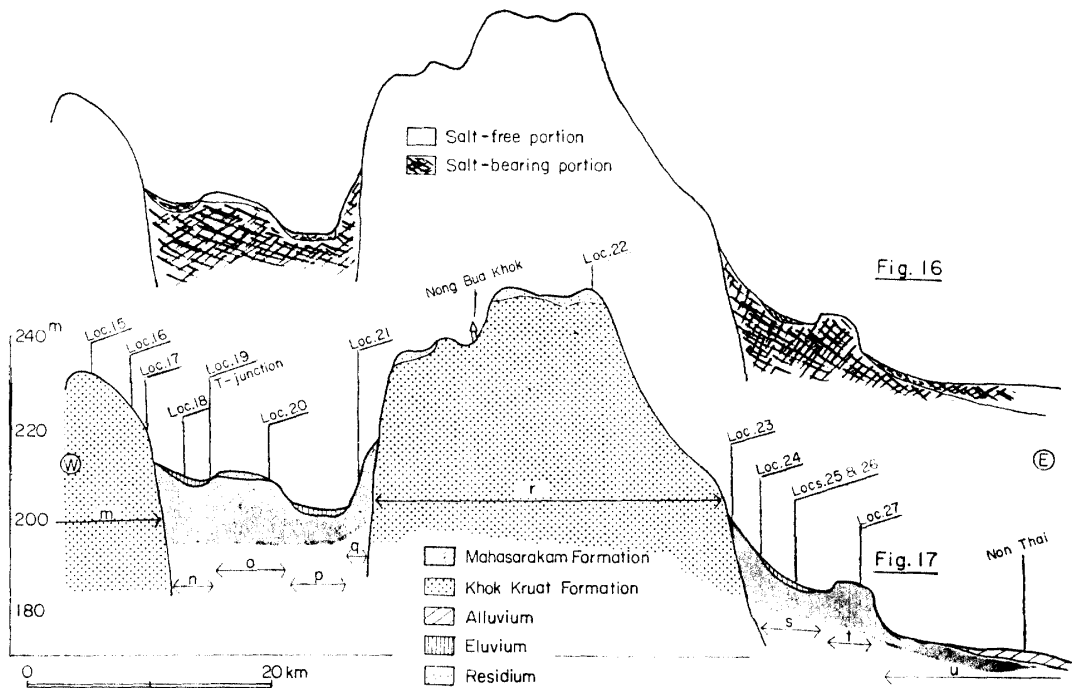

Fig. 16 & 17 The cross sections along the Non Thai-Chaibadan highway, showing the possible distribution of salt and the geomorphologic structure respectively

1.1–2.0 m: red sandstone; md R

viii) Description of cross section B

- m) A rolling hill composed of the Khok Kruat Formation; covered by *Dipterocarpus* trees and bushes; occasionally brownish red shale and sandstone outcrops; non or negligible salt indication
- n) An eluvial depression in the terrain of the Mahasarakam Formation; salt crusts are not rare, and such halophytic bushes as *Nam daeng* are common
- o) A hillock in the terrain of the Mahasarakam Formation covered by kenaf and bush; the near-surface layers 0.5 to 2.0 m is covered by sand which is free from salt, while the underlying shale and sandstone retain salt (as in the case of Loc. 20). According to local people, no wells can be utilized for drinking purpose on this hillock because of high salt content
- p) similar to (n)
- q) The area of the Mahasarakam Formation abutting to the Khok Kruat Formation; covered by bush; shale and sandstone outcrops often retain salt (like at Loc. 21)
- r) A rolling bush land with kenaf and cassava fields: Surface soils are mostly yellowish gray and locally reddish: no salt indication. This is the area of Khok Kruat Formation
- s) An eluvial valley developed on the Mahasarakam Formation; covered by paddy fields with common to many bush clumps; patches of salt crust are common
- t) An isolated hillock in an eluvial valley; slightly undulating and covered by cassava, kenaf and bush; no salt indication on the ground surface but salt-retaining Mesozoic rocks exist very close to the ground surface (like in Loc. 27)
- u) Transitional zone between eluvial valley to alluvial valley; very slightly undulating paddy field with few to common standing trees; occasionally salt crusts on the ground surface

III Conclusion

Based on the field evidences described above, the followings are made clear.

The source of salt

The origin of the salt is in the upper part of the Mahasarakam Formation, often referred to hitherto as “salt-free”. The salt which is associated with some shale and sandstone in the Mahasarakam Formation starts to be released during the process of weathering and thus enters the circulating groundwater. This mechanism is shown in a schematic picture of Fig. 18.

The occurrence of salt

In many cases, the occurrence of salt shows a kind of zonal arrangement, the zone of hill top, zone of hill-foot and zone of plain. On the hill top and its adjoining side slope,

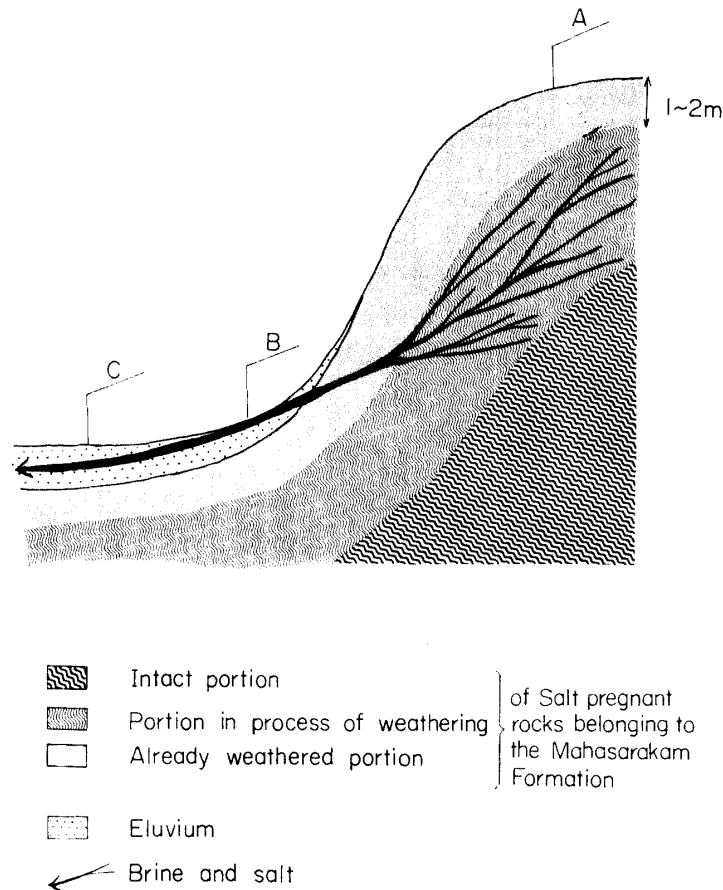

Fig. 18 A schematic cross section showing the mechanism of the extraction of salt from the salt Formation

salt occurs only in the deeper horizons than ca. 2 m as seen in Loc. A of Fig. 18, while along the base of hill slopes salt usually accumulates on the ground surface through seepage of the ground water, forming salt crusts during dry season as shown in Loc. B of Fig. 18. When water flows further away from the foot of hillslopes it penetrates into the sandy ground and salt also then may accumulates at certain depths below ground surface as in Loc. C of Fig. 18.

Acknowledgements

This report is the result of the joint field survey of one month, undertaken by the initiation of the Mekong Committee, supported by the Government of Thailand, by Thai soil scientists and a Japanese geomorphologist. Mr. Manop Tantatemeya and Mr. Rungsun Im-Erb, Soil and Water Conservation and Management Division, Land Development Department of Thailand, were with the authors during whole the survey period. Mr. Anunt Komes, Chief of Conservation and Management Division, Mr. Ying, Chief of Soil Survey Division, and Mr. Phichet Isarangura encouraged the authors and gave instructive informations.

Geologists of the Department of Mineral Resources of Thailand such as Mr. Sangop Kaewbaidhoo, Chief of Economic Geology Division, Mr. Charoen Phiancharoen, Chief of Groundwater Division, Miss Angoon, Head of Khorat Headquarter, and Mr. Thawat Jepekeset also gave the authors good advice and comments. The Mekong Committee, for whom one of the authors was working as a short-term expert during the survey period provided advice through such competent specialists as Dr. W. J. van Liere, agricultural planner, Dr. Workman, geologist, Mr. Roem, agronomist and Mr. Kawai, agricultural engineer. The authors are grateful to all the scientists mentioned above.

The publication of this report is made with the permission of Dr. Bancherd Balankura, Director General of Land Development Department, and Mr. W. J. van der Oord, Executive Agent of the Mekong Committee.